



User's Manual

MX67QM

Industrial Mini ITX Motherboard

WWW.BCMCOM.COM

Copyright Notice

The material in this document is the intellectual property of **BCM Advanced Research**. We take every care in the preparation of this document, but no guarantee is given as to the correctness of its contents. Our products are under continual improvement and we reserve the right to make changes without notice.

Trademarks

All trademarks are the properties of their respective owners.

- BCM® is registered trademark of BCM Advanced Research.
- NVIDIA® is registered trademark of NVIDIA Corporation.
- ATI® is registered trademark of ATI Technologies, Inc.
- AMD® is registered trademarks of AMD Corporation.
- Intel® is registered trademarks of Intel Corporation.
- Windows® is registered trademarks of Microsoft Corporation.
- AMI® is registered trademark of Advanced Micro Devices, Inc.
- Award® is a registered trademark of Phoenix Technologies Ltd.
- Realtek® is registered trademark of Realtek Semiconductor Corporation.

Revision History

Revision	Revision History	Date
V1.1	For PCB v1.x	August, 2011

Technical Support

If a problem arises with your system and no solution can be obtained from the user's manual, please contact your place of purchase or local distributor. Alternatively, please try the following help resources for further guidance.

- Visit the BCM website for technical guide, BIOS updates, driver updates, and other information: http://www.BCM.com/bcm_support_drivers.htm
- ☐ Contact our technical staff at: http://www.bcmcom.com/bcm_inquiries_techSupport.htm

Safety Instructions

- Always read the safety instructions carefully.
- Keep this User's Manual for future reference.
- Keep this equipment away from humidity.
- Lay this equipment on a reliable flat surface before setting it up.
- The openings on the enclosure are for air convection hence protects the equipment from overheating. **DO NOT COVER THE OPENINGS.**
- Make sure the voltage of the power source and adjust properly 110/220V before connecting the equipment to the power inlet.
- Place the power cord such a way that people can not step on it. Do not place anything over the power cord.
- Always Unplug the Power Cord before inserting any add-on card or module.
- All cautions and warnings on the equipment should be noted.
- Never pour any liquid into the opening that could damage or cause electrical shock.
- If any of the following situations arises, get the equipment checked by service personnel:
 - The power cord or plug is damaged.
 - Liquid has penetrated into the equipment.
 - The equipment has been exposed to moisture.
 - The equipment does not work well or you can not get it work according to User's Manual.
 - The equipment has dropped and damaged.
 - The equipment has obvious sign of breakage.
- **DO NOT LEAVE THIS EQUIPMENT IN AN ENVIRONMENT UNCONDITIONED, STORAGE TEMPERATURE ABOVE 60°C (140°F), IT MAY DAMAGE THE EQUIPMENT.**

CAUTION: Danger of explosion if battery is incorrectly replaced. Replace only with the same or equivalent type recommended by the manufacturer.

警告使用者:

這是甲類資訊產品，在居住的環境中使用時，可能會造成無線電干擾，在這種情況下，使用者會被要求採取某些適當的對策。



廢電池請回收

For better environmental protection, waste batteries should be collected separately for recycling or special disposal.

CE Conformity

Hereby, BCM Advanced Research declares that this device is in compliance with the essential safety requirements and other relevant provisions set out in the European Directive.



FCC-B Radio Frequency Interference Statement

This equipment has been tested and found to comply with the limits for a Class B digital device, pursuant to Part 15 of the FCC Rules. These limits are designed to provide reasonable protection against harmful interference in a residential installation. This equipment generates, uses and can radiate radio frequency energy and, if not installed and used in accordance with the instruction manual, may cause harmful interference to radio communications. However, there is no guarantee that interference will not occur in a particular installation. If this equipment does cause harmful interference to radio or television reception, which can be determined by turning the equipment off and on, the user is encouraged to try to correct the interference by one or more of the measures listed below:



- Reorient or relocate the receiving antenna.
- Increase the separation between the equipment and receiver.
- Connect the equipment into an outlet on a circuit different from that to which the receiver is connected.
- Consult the dealer or an experienced radio/television technician for help.

NOTICE 1

The changes or modifications not expressly approved by the party responsible for compliance could void the user's authority to operate the equipment.

NOTICE 2

Shielded interface cables and AC power cord, if any, must be used in order to comply with the emission limits.

VOIR LA NOTICE D'INSTALLATION AVANT DE RACCORDER AU RESEAU.

This device complies with Part 15 of the FCC Rules. Operation is subject to the following two conditions:

1. this device may not cause harmful interference, and
2. this device must accept any interference received, including interference that may cause undesired operation.

WEEE Statement

ENGLISH

To protect the global environment and as an environmentalist, BCM must remind you that:



Under the European Union ("EU") Directive on Waste Electrical and Electronic Equipment, Directive 2002/96/EC, which takes effect on August 13, 2005, products of "electrical and electronic equipment" cannot be discarded as municipal waste anymore and manufacturers of covered electronic equipment will be obligated to take back such products at the end of their useful life. BCM will comply with the product take back requirements at the end of life of BCM-branded products that are sold into the EU. You can return these products to local collection points.

DEUTSCH

Hinweis von BCM zur Erhaltung und Schutz unserer Umwelt

Gemäß der Richtlinie 2002/96/EG über Elektro- und Elektronik-Altgeräte dürfen Elektro- und Elektronik-Altgeräte nicht mehr als kommunale Abfälle entsorgt werden. BCM hat europaweit verschiedene Sammel- und Recyclingunternehmen beauftragt, die in die Europäische Union in Verkehr gebrachten Produkte, am Ende seines Lebenszyklus zurückzunehmen. Bitte entsorgen Sie dieses Produkt zum gegebenen Zeitpunkt ausschliesslich an einer lokalen Altgerätesammelstelle in Ihrer Nähe.

FRANÇAIS

En tant qu'écologiste et afin de protéger l'environnement, BCM tient à rappeler ceci:

Au sujet de la directive européenne (EU) relative aux déchets des équipement électriques et électroniques, directive 2002/96/EC, prenant effet le 13 août 2005, que les produits électriques et électroniques ne peuvent être déposés dans les décharges ou tout simplement mis à la poubelle. Les fabricants de ces équipements seront obligés de récupérer certains produits en fin de vie. BCM prendra en compte cette exigence relative au retour des produits en fin de vie au sein de la communauté européenne. Par conséquent vous pouvez retourner localement ces matériels dans les points de collecte.

РУССКИЙ

Компания BCM предпринимает активные действия по защите окружающей среды, поэтому напоминаем вам, что:

В соответствии с директивой Европейского Союза (ЕС) по предотвращению загрязнения окружающей среды использованным электрическим и электронным оборудованием (директива WEEE 2002/96/ЕС), вступающей в силу 13 августа 2005 года, изделия, относящиеся к электрическому и электронному оборудованию, не могут рассматриваться как бытовой мусор, поэтому производители вышеперечисленного электронного оборудования обязаны принимать его для переработки по окончании срока службы. BCM обязуется соблюдать требования по приему продукции, проданной под маркой BCM на территории ЕС, в переработку по окончании срока службы. Вы можете вернуть эти изделия в специализированные пункты приема.

ESPAÑOL

BCM como empresa comprometida con la protección del medio ambiente, recomienda: Bajo la directiva 2002/96/EC de la Unión Europea en materia de desechos y/o equipos electrónicos, con fecha de rigor desde el 13 de agosto de 2005, los productos clasificados como "eléctricos y equipos electrónicos" no pueden ser depositados en los contenedores habituales de su municipio, los fabricantes de equipos electrónicos, están obligados a hacerse cargo de dichos productos al término de su período de vida. BCM estará comprometido con los términos de recogida de sus productos vendidos en la Unión Europea al final de su periodo de vida. Usted debe depositar estos productos en el punto limpio establecido por el ayuntamiento de su localidad o entregar a una empresa autorizada para la recogida de estos residuos.

NEDERLANDS

Om het milieu te beschermen, wil BCM u eraan herinneren dat:

De richtlijn van de Europese Unie (EU) met betrekking tot Vervuiling van Electricische en Electronische producten (2002/96/EC), die op 13 Augustus 2005 in zal gaan kunnen niet meer beschouwd worden als vervuiling. Fabrikanten van dit soort producten worden verplicht om producten retour te nemen aan het eind van hun levenscyclus. BCM zal overeenkomstig de richtlijn handelen voor de producten die de merknaam BCM dragen en verkocht zijn in de EU. Deze goederen kunnen geretourneerd worden op lokale inzamelingspunten.

SRPSKI

Da bi zaštitili prirodnu sredinu, i kao preduzeće koje vodi računa o okolini i prirodnoj sredini, BCM mora da vas podesti da:

Po Direktivi Evropske unije ("EU") o odbačenju elektonskoj i električnoj opremi, Direktiva 2002/96/EC, koja stupa na snagu od 13. Avgusta 2005, proizvodi koji spadaju pod "elektronsku i električnu opremu" ne mogu više biti odbačeni kao običan otpad i proizvođači ove opreme biće prinuđeni da uzmu natrag ove proizvode na kraju njihovog uobičajenog veka trajanja. BCM će poštovati zahtev na preuzimanju ovakvih proizvoda kojima je istekao vek trajanja, koji imaju BCM oznaku i koji su prodati u EU. Ove proizvode možete vratiti na lokalnim mestima za prikupljanje.

POLSKI

Aby chronić nasze środowisko naturalne oraz jako firma dbająca o ekologię, BCM przypomina, że:

Zgodnie z Dyrektywą Unii Europejskiej ("UE") dotyczącą odpadów produktów elektrycznych i elektronicznych (Dyrektywa 2002/96/EC), która wchodzi w życie 13 sierpnia 2005, tzw. "produkty oraz wyposażenie elektryczne i elektroniczne" nie mogą być traktowane jako śmieci komunalne, tak więc producenci tych produktów będą zobowiązani do odbierania ich w momencie gdy produkt jest wycofywany z użycia. BCM wypełni wymagania UE, przyjmując produkty (sprzedawane na terenie Unii Europejskiej) wycofywane z użycia. Produkty BCM będzie można zwracać w wyznaczonych punktach zbiorczych.

TÜRKÇE

Çevreci özelliğiyle bilinen BCM dünyada çevreyi korumak için hatırlatır:

Avrupa Birliği (AB) Kararnamesi Elektrik ve Elektronik Malzeme Atığı, 2002/96/EC Kararnamesi altında 13 Ağustos 2005 tarihinden itibaren geçerli olmak üzere, elektrikli ve elektronik malzemeler diğer atıklar gibi çöpe atılmayacak ve bu elektronik cihazların üreticileri, cihazların kullanım süreleri bittikten sonra ürünleri geri toplamakla yükümlü olacaktır. Avrupa Birliği'ne satılan BCM markalı ürünlerin kullanım süreleri bittiğinde BCM ürünlerin geri alınması isteği ile işbirliği içerisinde olacaktır. Ürünlerinizi yerel toplama noktalarına bırakabilirsiniz.

ČESKY

Záleží nám na ochraně životního prostředí - společnost BCM upozorňuje:

Podle směrnice Evropské unie ("EU") o likvidaci elektrických a elektronických výrobků 2002/96/EC platné od 13. srpna 2005 je zakázáno likvidovat "elektrické a elektronické výrobky" v běžném komunálním odpadu a výrobci elektronických výrobků, na které se tato směrnice vztahuje, budou povinni odebírat takové výrobky zpět po skončení jejich životnosti. Společnost BCM splní požadavky na odebrání výrobků značky BCM, prodávaných v zemích EU, po skončení jejich životnosti. Tyto výrobky můžete odevzdat v místních sběrnách.

MAGYAR

Annak érdekében, hogy környezetünket megvédjük, illetve környezetvédként fellépve az BCM emlékezteti Önt, hogy:

Az Európai Unió („EU”) 2005. augusztus 13-án hatályba lépő, az elektromos és elektronikus berendezések hulladékairól szóló 2002/96/EK irányelve szerint az elektromos és elektronikus berendezések többé nem kezelhetőek lakossági hulladékként, és az ilyen elektronikus berendezések gyártói kötelessé válnak az ilyen termékek visszavételére azok hasznos élettartama végén. Az BCM betartja a termékviszavétellel kapcsolatos követelményeket az BCM márkanév alatt az EU-n belül értékesített termékek esetében, azok élettartamának végén. Az ilyen termékeket a legközelebbi gyűjtőhelyre viheti.

ITALIANO

Per proteggere l'ambiente, BCM, da sempre amica della natura, ti ricorda che:

In base alla Direttiva dell'Unione Europea (EU) sullo Smaltimento dei Materiali Elettrici ed Elettronici, Direttiva 2002/96/EC in vigore dal 13 Agosto 2005, prodotti appartenenti alla categoria dei Materiali Elettrici ed Elettronici non possono più essere eliminati come rifiuti municipali: i produttori di detti materiali saranno obbligati a ritirare ogni prodotto alla fine del suo ciclo di vita. BCM si adeguerà a tale Direttiva ritirando tutti i prodotti marchiati BCM che sono stati venduti all'interno dell'Unione Europea alla fine del loro ciclo di vita. È possibile portare i prodotti nel più vicino punto di raccolta

CONTENTS

Copyright Notice	ii
Trademarks	ii
Revision History	ii
Safety Instructions	iii
CE Conformity.....	iv
FCC-B Radio Frequency Interference Statement	iv
WEEE Statement	v
Chapter 1 Overview	1-1
Mainboard Specifications.....	1-2
Mainboard Layout	1-4
Chapter 2 Hardware Setup.....	2-1
Quick Components Guide.....	2-2
CPU	2-3
Memory	2-4
Power Supply	2-5
Back Panel I/O	2-6
Connector	2-9
Jumper	2-16
Slot.....	2-18
Chapter 3 BIOS Setup	3-1
Entering Setup	3-2
The Menu Bar	3-4
Main	3-5
Advanced	3-7
Boot.....	3-15
Security	3-16
Chipset.....	3-22
Power.....	3-24
Save & Exit	3-26

Chapter 1



Overview

The MX67QM is an Intel® QM67 Mini ITX Motherboard which supports the 2nd generation Intel® Core™ i7, i5, i3 Mobile processors providing advanced computing and graphics performance for gaming, POS, digital signage and server market segment

Based on the innovative Intel® Cougar Point chipset for optimal system efficiency, the MX67QM accommodates the Mobile Intel® Core i3/ i5/ i7/ Celeron/ Pentium processor in socket PGA989 and supports up to 2 DDR3 1066/1333/1600 SO-DIMM slots to provide the maximum of 8GB memory capacity.

In the advanced-level and mid-range market segment, the MX67QM provides a high-performance solution for today's front-end and general purpose workstation, as well as in the future.

MX67QM Specifications

CPU	<ul style="list-style-type: none"> ■ Mobile Intel Core i3/ i5/ i7/ Celeron/ Pentium processor (below 45 Watt) in socket PGA989
Chipset	<ul style="list-style-type: none"> ■ North Bridge: integrated with CPU ■ South Bridge: Intel Cougar Point chipset
Memory	<ul style="list-style-type: none"> ■ 2 DDR3 1066/1333/1600 SO-DIMM slots ■ Supports the maximum of 8GB
LAN	<ul style="list-style-type: none"> ■ LAN 1: Intel® 82579LM PHY Gigabit LAN Controller ■ LAN 2: Intel® 82574L PCIe Gigabit LAN Controller
Audio	<ul style="list-style-type: none"> ■ Realtek® ALC887 HD Audio ■ Audio Interface: Line-out, Mic-in, Line-in, 1 x SPDIF Header, 1 x Front Audio Header, 1 x Amplifier Header ■ 3 Watt/Channel Amplifier
Graphics	<ul style="list-style-type: none"> ■ Intel Gen6.0 integrated Graphics Engine ■ Up to QXGA (2048 x 1536) resolution
Expansion Interface	<ul style="list-style-type: none"> ■ 1 x PCI Express x16 ■ 1 x Mini PCI Express ■ 1 x Compact Flash socket by Intel Cougar Point
RAID	<ul style="list-style-type: none"> ■ SATA1~4 support Intel Rapid Storage Technology ■ (AHCI/ RAID 0/ 1/ 5/ 10) by Intel Cougar Point ■ Supports SSD caching for system acceleration
Back I/O Panel	<ul style="list-style-type: none"> ■ 1 x PS/2 mouse port ■ 1 x PS/2 keyboard port ■ 1 x VGA port ■ 1 x DVI-D port ■ 1 x COM port ■ 1 x HDMI port ■ 2 x Gigabit LAN jacks ■ 2 x USB 2.0 ports ■ 2 x USB 3.0 ports ■ 1 x Line-In audio jack ■ 1 x Line-Out audio jack ■ 1 x Mic-In audio jack

Onboard I/O Headers	<ul style="list-style-type: none">■ 2 x USB 2.0 pinheaders (4 ports)■ 1 x Amplifier pinheader■ 4 x COM port connectors■ 1 x GPIO pinheader■ 1 x LVDS connector■ 1 x Front audio pinheader■ 1 x Chassis intrusion pinheader■ 1 x SPDIF pinheader
Form Factor	<ul style="list-style-type: none">■ 6.7" (L) x 6.7" (W)
Power Type	<ul style="list-style-type: none">■ 20 + 4-pin ATX Power
Mechanical and Environment	<ul style="list-style-type: none">■ Operating Temperature: -10°C to 60°C■ Storage Temperature: -20°C to 80°C■ Humidity: 0% ~ 90% RH, Non-Condensing

Mainboard Layout

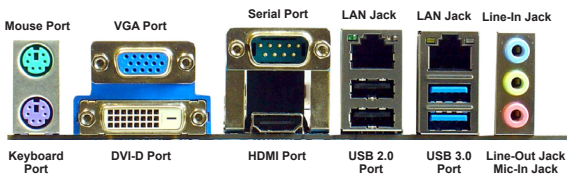
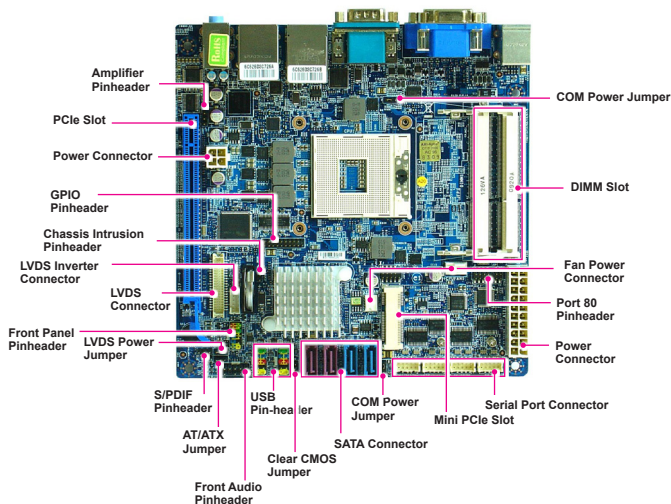

Chapter 2

Hardware Setup

This chapter provides you with the information on mainboard hardware configurations. Incorrect setting of jumpers and connectors may damage your mainboard. Please pay special attention not to connect these headers in wrong direction. DO NOT adjust any jumper while the mainboard is powered on.

Quick Components Guide

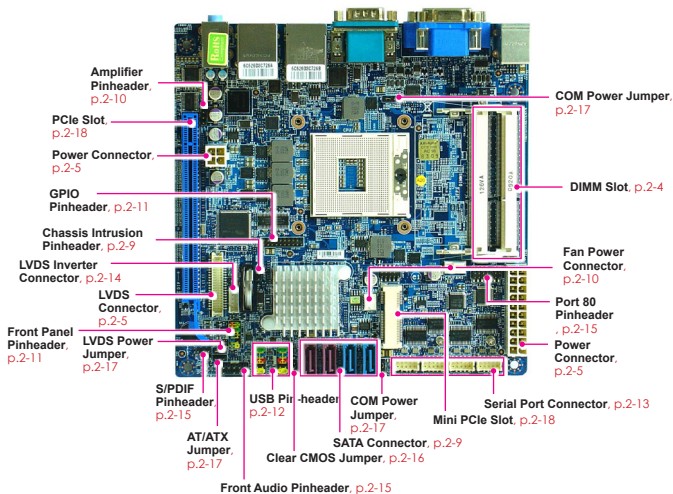

Back I/O, p.2-5

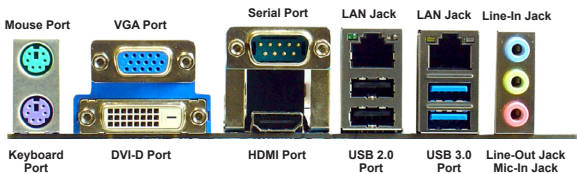

CPU

► Installing the CPU

Important

- *On the upper end of the CPU socket is a socket actuator in the form of a slotted screw head. Make sure that you open or close the socket with a flathead screwdriver before and after installing the CPU.*
 - *When installing the CPU, make sure the cooler set is installed as well and can work properly to protect the CPU from overheating. For proper CPU cooler type, please consult the dealer.*
1. Turn the socket actuator counterclockwise to open the socket.
 2. Place the CPU on top of the socket. Make sure that the gold arrow on the CPU is aligned with the arrow key on the socket.
 3. Push the CPU gently down until its pins securely fit into the socket.
 4. Turn the socket actuator clockwise to close the socket and secure the CPU in place.

Memory

► Installing Memory Modules

1. Locate the SO-DIMM slot. Align the notch on the DIMM with the key on the slot and insert the DIMM into the slot.
2. Push the DIMM gently downwards until the slot levers click and lock the DIMM in place.
3. To uninstall the DIMM, flip the slot levers outwards and the DIMM will be released instantly.

Important

You can barely see the golden finger if the memory module is properly inserted in the DIMM slot.

Power Supply

ATX Power Connector: ATX1

This connector provides power to the system.

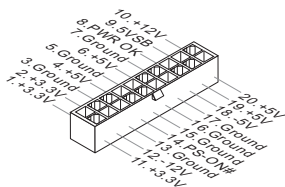

DC Power Connector: JPWR1

This connector provides 12V DC power input.

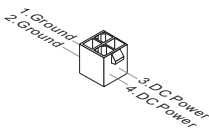

Back Panel I/O

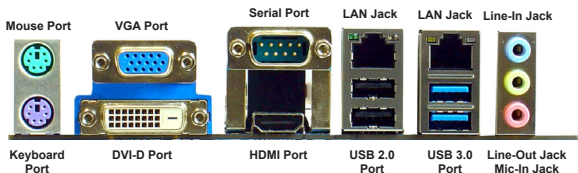

▶ Mouse/Keyboard Port

The standard PS/2 mouse/keyboard DIN connector is for a PS/2 mouse/keyboard.

▶ VGA Port

The DB15-pin female connector is provided for monitor.

▶ DVI-D Port

The DVI-D (Digital Visual Interface-Digital) connector allows you to connect an LCD monitor. It provides a high-speed digital interconnection between the computer and its display device. To connect an LCD monitor, simply plug your monitor cable into the DVI connector, and make sure that the other end of the cable is properly connected to your monitor (refer to your monitor manual for more information.)

► RS-232/422/485 Serial Port Connector (Optional)

The serial port is a 16550A high speed communications port that sends/receives 16 bytes FIFOs. You can attach a serial mouse or other serial devices directly to the connector.

RS-232

PIN	SIGNAL	DESCRIPTION
1	DCD	Data Carrier Detect
2	RXD	Receive Data
3	TXD	Transmit Data
4	DTR	Data Terminal Ready
5	GND	Signal Ground
6	DSR	Data Set Ready
7	RTS	Request To Send
8	CTS	Clear To Send
9	VCC_COM1	Voltage select setting by J1

RS-422

PIN	SIGNAL	DESCRIPTION
1	422 TXD-	Transmit Data, Negative
2	422 RXD+	Receive Data, Positive
3	422 TXD+	Transmit Data, Positive
4	422 RXD-	Receive Data, Negative
5	GND	Signal Ground
6	NC	No Connection
7	NC	No Connection
8	NC	No Connection
9	NC	No Connection

RS-485

PIN	SIGNAL	DESCRIPTION
1	485 TXD-	Transmit Data, Negative
2	NC	No Connection
3	485 TXD+	Transmit Data, Positive
4	NC	No Connection
5	GND	Signal Ground
6	NC	No Connection
7	NC	No Connection
8	NC	No Connection
9	NC	No Connection

▶ **HDMI Port**

The High-Definition Multimedia Interface (HDMI) is an all-digital audio/video interface capable of transmitting uncompressed streams. HDMI supports all TV format, including standard, enhanced, or high-definition video, plus multi-channel digital audio on a single cable.

▶ **USB 2.0 Port**

The USB 2.0 port is for attaching USB devices such as keyboard, mouse, or other USB compatible devices. It supports data transfer rate up to 480Mbit/s (Hi-Speed).

▶ **USB 3.0 Port**

The USB 3.0 port is backward-compatible with USB 2.0 devices and supports data transfer rate up to 5 Gbit/s (SuperSpeed).

▶ **LAN**

The standard RJ-45 LAN jack is for connection to the Local Area Network (LAN). You can connect a network cable to it.



		Left LED (Active LED)	Right LED (100M/1000M Speed LED)
LED Color		Yellow	Green/Orange
10M Cable Plug-in	No Transmission	Yellow (Lighting)	OFF
	Transmission	Yellow (Blinking)	OFF
100M Cable Plug-in	No Transmission	Yellow (Lighting)	Green (Lighting)
	Transmission	Yellow (Blinking)	Green (Lighting)
1000M Cable Plug-in	No Transmission	Yellow (Lighting)	Orange (Lighting)
	Transmission	Yellow (Blinking)	Orange (Lighting)
In S3/S4/S5 Standby State		Yellow (Lighting)	OFF

▶ **Audio Jack**

- **Line-In (Blue)** - for external CD player or other audio devices
- **Line-Out (Green)** - for speakers or headphones
- **Mic (Pink)** - for microphones

Connector

Chassis Intrusion Pinheader: JCASE1

This connector is provided to connect the chassis intrusion switch cable. If the chassis is opened, the chassis intrusion mechanism will be activated. The system will record this status and show a warning message on the screen. To clear the warning, you must enter the BIOS utility and clear the record.

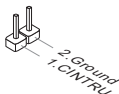

Serial ATA Connector: SATA1 ~ SATA4

This connector is a high-speed Serial ATA interface port. Each connector can connect one Serial ATA device.

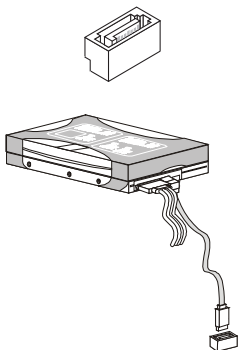

Important

Please do not fold the Serial ATA cable into 90-degree angle. Otherwise, data loss may occur during transmission.

Audio Amplifier Pinheader: JAMP1

The JAMP1 is used to connect audio amplifiers to enhance audio performance.

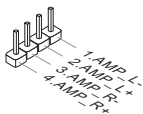

Fan Power Connector: CPUFAN1, SYSFAN1

The fan power connector supports system cooling fan with +12V. When connecting the wire to the connectors, always note that the red wire is the positive and should be connected to the +12V; the black wire is Ground and should be connected to GND. If the mainboard has a System Hardware Monitor chipset onboard, you must use a specially designed fan with speed sensor to take advantage of the CPU fan control.

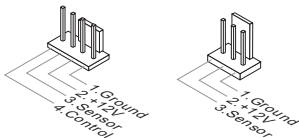

Important

- Please refer to the recommended CPU fans at processor's official website or consult the vendors for proper CPU cooling fan.
- Fan cooler set with 3- or 4-pin power connector are both available for CPUFAN1.

GPIO Pinheader: JGPIO1

This connector is provided for the General-Purpose Input/Output (GPIO) peripheral module.

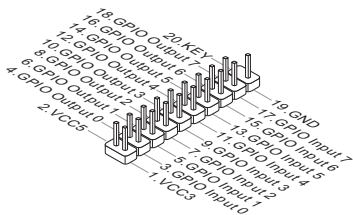

Front Panel Pinheader: JFP1

This front panel connector is provided for electrical connection to the front panel switches & LEDs and is compliant with Intel Front Panel I/O Connectivity Design Guide.

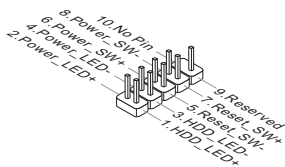

Front USB Pinheader: JUSB1, JUSB2

This connector, compliant with Intel I/O Connectivity Design Guide, is ideal for connecting high-speed USB interface peripherals such as USB HDD, digital cameras, MP3 players, printers, modems and the like.

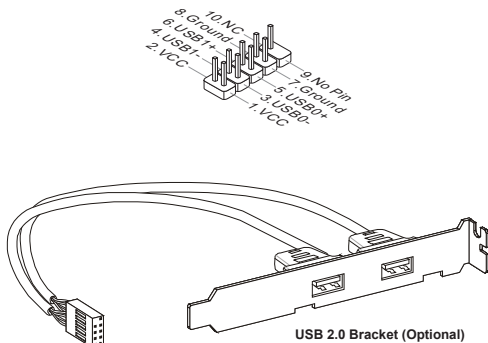

Important

Note that the pins of VCC and GND must be connected correctly to avoid possible damage.

Serial Port Connector: COM2, COM3, COM4, COM5

This connector is a 16550A high speed communications port that sends/ receives 16 bytes FIFOs. You can attach a serial device to it through an optional serial port bracket.

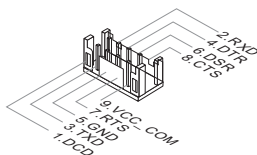

PIN	SIGNAL	DESCRIPTION
1	DCD	Data Carrier Detect
2	RXD	Receive Data
3	TXD	Transmit Data
4	DTR	Data Terminal Ready
5	GND	Signal Ground
6	DSR	Data Set Ready
7	RTS	Request To Send
8	CTS	Clear To Send
9	VCC_COM	12V or 5V power output, selected by JCMV2

LVDS Inverter Connector: JINV1

The connector is provided for LCD backlight options.

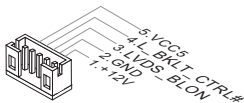

LVDS Connector: JLVD51

The LVDS (Low Voltage Differential Signal) connector provides a digital interface typically used with flat panels. After connecting an LVDS interface flat panel to the JLVD51, be sure to check the panel datasheet and set the JVDD1 jumper to proper power voltage.

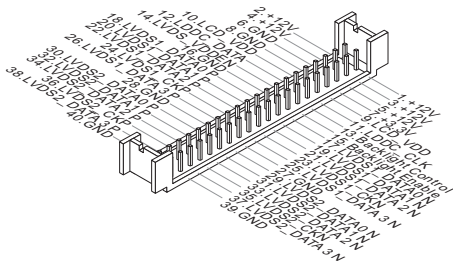

S/PDIF Pinheader: JSPDI1

This connector is used to connect S/PDIF (Sony & Philips Digital Interconnect Format) interface for digital audio transmission.

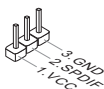

Front Audio Pinheader: JAUD1

This connector allows you to connect the front panel audio and is compliant with Intel Front Panel I/O Connectivity Design Guide.

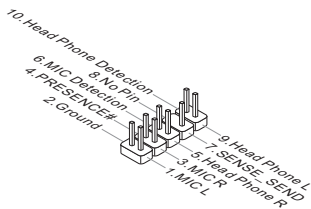

Port 80 Pinheader: JDP1

This pinheader is intended for Transport Control Protocol (TCP) port 80.

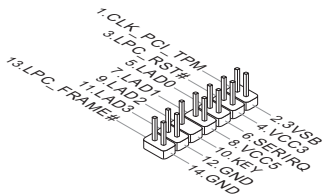

Jumper

Clear CMOS Jumper: JCMOS1

There is a CMOS RAM onboard that has a power supply from an external battery to keep the data of system configuration. With the CMOS RAM, the system can automatically boot OS every time it is turned on. If you want to clear the system configuration, set the jumper to clear data.



JCMOS1



Clear CMOS



Keep CMOS

Important

You can clear CMOS by shorting 2-3 pin while the system is off. Then return to 1-2 pin position. Avoid clearing the CMOS while the system is on; it will damage the mainboard.

AT/ATX Select Jumper: JAT1

This jumper allows users to select between AT and ATX power.



JAT1



AT Power



ATX Power

COM Port Power Jumper: J1, JCMV2

These jumpers specify the operation voltage of the onboard serial ports.



J1
(for COM1)



+5V



+12V



JCMV2
(for COM2~5)



+12V



+5V

LVDS Power Jumper: J2

Use this jumper to specify the operation voltage of the LVDS interface flat panel.



J2



+3.3V



+5V

Slot

Mini PCI-E (Peripheral Component Interconnect Express) Slot

The Mini PCI-E slot is provided for wireless LAN card, TV tuner card, and Robson NAND Flash card.

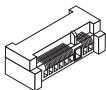

PCI-E (Peripheral Component Interconnect Express) Slot

The PCIe slot supports the PCIe interface expansion card.

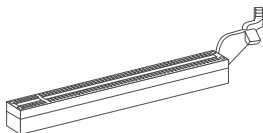

CompactFlash Socket

This socket supports CompactFlash cards.

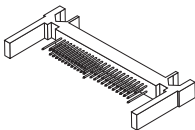

Important

When adding or removing expansion cards, make sure that you unplug the power supply first. Meanwhile, read the documentation for the expansion card to configure any necessary hardware or software settings for the expansion card, such as jumpers, switches or BIOS configuration.

Chapter 3

BIOS Setup

This chapter provides information on the BIOS Setup program and allows you to configure the system for optimum use.

You may need to run the Setup program when:

- An error message appears on the screen during the system booting up, and requests you to run SETUP.
- You want to change the default settings for customized features.

Entering Setup

Power on the computer and the system will start POST (Power On Self Test) process. When the message below appears on the screen, press key to enter Setup.

Press DEL to enter SETUP

If the message disappears before you respond and you still wish to enter Setup, restart the system by turning it OFF and On or pressing the RESET button. You may also restart the system by simultaneously pressing <Ctrl>, <Alt>, and <Delete> keys.

Important

The items under each BIOS category described in this chapter are under continuous update for better system performance. Therefore, the description may be slightly different from the latest BIOS and should be held for reference only.

Control Keys

← →	Select Screen
↑ ↓	Select Item
Enter	Select
+ -	Change Option
F1	General Help
F7	Previous Values
F9	Optimized Defaults
F10	Save & Exit
Esc	Exit

Getting Help

After entering the Setup menu, the first menu you will see is the Main Menu.

Main Menu

The main menu lists the setup functions you can make changes to. You can use the arrow keys (↑ ↓) to select the item. The on-line description of the highlighted setup function is displayed at the bottom of the screen.

Sub-Menu

If you find a right pointer symbol  appears to the left of certain fields that means a sub-menu can be launched from this field. A sub-menu contains additional options for a field parameter. You can use arrow keys (↑ ↓) to highlight the field and press <Enter> to call up the sub-menu. Then you can use the control keys to enter values and move from field to field within a sub-menu. If you want to return to the main menu, just press the <Esc >.

General Help <F1>

The BIOS setup program provides a General Help screen. You can call up this screen from any menu by simply pressing <F1>. The Help screen lists the appropriate keys to use and the possible selections for the highlighted item. Press <Esc> to exit the Help screen.

The Menu Bar

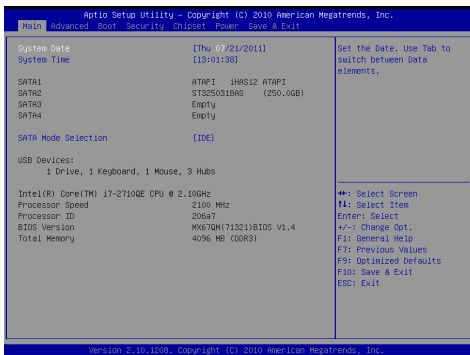

► **Main**

Use this menu for basic system configurations, such as time, date, etc.

► **Advanced**

Use this menu to set up the items of special enhanced features.

► **Boot**

Use this menu to specify the priority of boot devices.

► **Security**

Use this menu to set supervisor and user passwords.

► **Chipset**

This menu controls the advanced features of the onboard chipsets.

► **Power**

Use this menu to specify your settings for power management.

► **Save & Exit**

This menu allows you to load the BIOS default values or factory default settings into the BIOS and exit the BIOS setup utility with or without changes.

Main

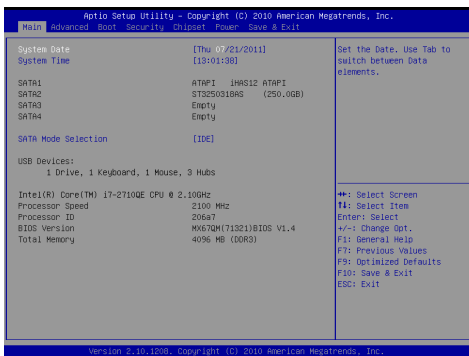

► System Date

This setting allows you to set the system date. The date format is <Day>, <Month> <Date> <Year>.

► System Time

This setting allows you to set the system time. The time format is <Hour> <Minute> <Second>.

► SATA1/ 2/ 3/ 4

[Type]	Press PgUp/<+> or PgDn/<-> to select [Manual], [None] or [Auto] type. Note that the specifications of your drive must match with the drive table. The hard disk will not work properly if you enter improper information for this category. If your hard disk drive type is not matched or listed, you can use [Manual] to define your own drive type manually.
--------	---

[LBA/Large Mode]	Enabling LBA causes Logical Block Addressing to be used in place of Cylinders, Heads and Sectors
[Block (Multi-Sector Transfer)]	Any selection except Disabled determines the number of sectors transferred per block
[PIO Mode]	Indicates the type of PIO (Programmed Input/Output)
[DMA Mode]	Indicates the type of Ultra DMA
[S.M.A.R.T.]	This allows you to activate the S.M.A.R.T. (Self-Monitoring Analysis & Reporting Technology) capability for the hard disks. S.M.A.R.T is a utility that monitors your disk status to predict hard disk failure. This gives you an opportunity to move data from a hard disk that is going to fail to a safe place before the hard disk becomes offline.
[32 Bit Data Transfer]	Enables 32-bit communication between CPU and IDE controller

► **SATA Mode Selection**

This setting specifies the SATA controller mode.

Advanced

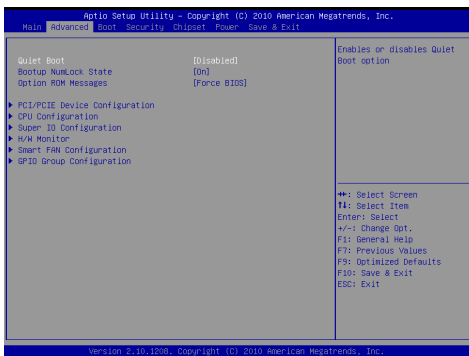

▶ Quiet Boot

This BIOS feature determines if the BIOS should hide the normal POST messages with the motherboard or system manufacturer's full-screen logo. When it is enabled, the BIOS will display the full-screen logo during the boot-up sequence, hiding normal POST messages.

When it is disabled, the BIOS will display the normal POST messages, instead of the full-screen logo.

Please note that enabling this BIOS feature often adds 2-3 seconds of delay to the booting sequence. This delay ensures that the logo is displayed for a sufficient amount of time. Therefore, it is recommended that you disable this BIOS feature for a faster boot-up time.

▶ Bootup NumLock State

This setting is to set the Num Lock status when the system is powered on. Setting to [On] will turn on the Num Lock key when the system is powered on. Setting to [Off] will allow users to use the arrow keys on the numeric keypad.

► **Option ROM Messages**

This item is used to determine the display mode when an optional ROM is initialized during POST. When set to [Force BIOS], the display mode used by AMI BIOS is used. Select [Keep Current] if you want to use the display mode of optional ROM.

► **PCI/PCIE Device Configuration**

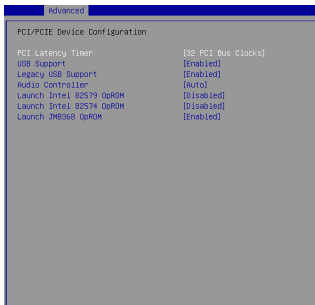

► **PCI Latency Timer**

This item controls how long each PCI device can hold the bus before another takes over. When set to higher values, every PCI device can conduct transactions for a longer time and thus improve the effective PCI bandwidth. For better PCI performance, you should set the item to higher values.

► **USB Support**

This setting enables/disables support for USB devices.

► **Legacy USB Support**

Set to [Enabled] if you need to use any USB 1.1/2.0 device in the operating system that does not support or have any USB 1.1/2.0 driver installed, such as DOS and SCO Unix.

► **Audio Controller**

This setting enables/disables the onboard audio controller.

► **Launch Intel 82579 OpROM, Launch Intel 82574 OpROM, Launch JMB368 OpROM**

This setting enables/disables the initialization of the onboard LAN Boot ROM during bootup. Selecting [Disabled] will speed up the boot process.

► **CPU Configuration**

Advanced	
CPU Configuration	
Intel(R) Core(TM) i7-2710QE CPU @ 2.10GHz	
Processor ID	206a7
Microcode Revision	14
Max Processor Speed	2100 MHz
Min Processor Speed	600 MHz
Processor Speed	2100 MHz
Processor Cores	4
Intel HT Technology	Supported
EMT64	Supported
Hyper-Threading	[Enabled]
Active Processor Cores	[All]
Limit CPUID Maximum	[Disabled]
Execute Disable Bit	[Enabled]
Intel Virtualization Technology	[Disabled]
EIST	[Enabled]
Turbo Mode	[Enabled]

► **Hyper Threading**

The processor uses Hyper-Threading technology to increase transaction rates and reduces end-user response times. The technology treats the two cores inside the processor as two logical processors that can execute instructions simultaneously. In this way, the system performance is highly improved. If you disable the function, the processor will use only one core to execute the instructions. Please disable this item if your operating system doesn't support HT Function, or unreliability and instability may occur.

► **Active Processor Cores**

This setting specifies the number of active processor cores.

► **Limit CPUID Maximum**

The Max CPUID Value Limit BIOS feature allows you to circumvent problems with older operating systems that do not support the Intel Pentium 4 processor with Hyper-Threading Technology. When enabled, the processor will limit the maximum CPUID input value to 03h when queried, even if the processor supports a higher CPUID input value. When disabled, the processor will return the actual maximum CPUID input value of the processor when queried.

► **Execute Disable Bit**

Intel's Execute Disable Bit functionality can prevent certain classes of malicious "buffer overflow" attacks when combined with a supporting operating system. This functionality allows the processor to classify areas in memory by where application code can execute and where it cannot. When a malicious worm attempts to insert code in the buffer, the processor disables code execution, preventing damage or worm propagation.

► **Intel Virtualization Technology**

Virtualization enhanced by Intel Virtualization Technology will allow a platform to run multiple operating systems and applications in independent partitions. With virtualization, one computer system can function as multiple "virtual" systems.

► **EIST**

EIST (Enhanced Intel SpeedStep Technology) allows the system to dynamically adjust processor voltage and core frequency, which can result in decreased average power consumption and decreased average heat production.

► **Turbo Mode**

Intel Turbo Memory is a new Intel platform technology that uses non-volatile memory (Flash memory) to increase system responsiveness, make multi-tasking faster, and extend battery life. This technology is poised to eliminate many of the bottlenecks associated with HDD latency. By enabling the majority of application workload to be written and read from a system cache instead of the HDD, Turbo Memory will offer users significantly increased performance -- particularly in application load and run time, the speed in which systems resume operation after hibernation or boot, and in system-level power usage.

► Super IO Configuration

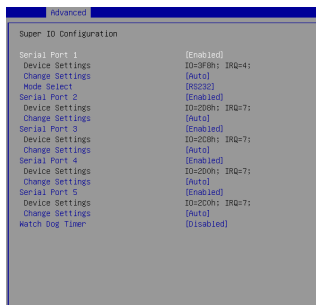

► Serial Port 1/ 2/ 3/ 4/ 5

This setting enables/disables the specified serial port.

► Change Settings

This setting is used to change the address & IRQ settings of the specified serial port.

► Mode Select

Select an operation mode for the serial port 1.

► Watch Dog Timer

You can enable the system watch-dog timer, a hardware timer that generates a reset when the software that it monitors does not respond as expected each time the watch dog polls it.

► **H/W Monitor**

These items display the current status of all monitored hardware devices/ components such as voltages, temperatures and all fans' speeds.

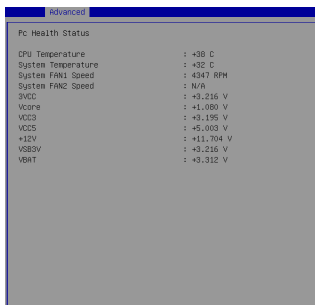

Advanced	
Pc Health Status	
CPU Temperature	: +38 C
System Temperature	: +32 C
System FAN1 Speed	: 4347 RPM
System FAN2 Speed	: N/A
3VCC	: +3.216 V
Vcore	: +1.080 V
VCC3	: +3.195 V
VCC5	: +5.003 V
+12V	: +11.704 V
VSB3v	: +3.216 V
VBAT	: +3.312 V

► Smart Fan Configuration

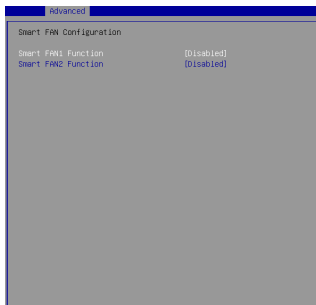

► Smart FAN1 / FAN2 Function

This setting enables/disables the Smart Fan function. Smart Fan is an excellent feature which will adjust the CPU/system fan speed automatically depending on the current CPU/system temperature, avoiding the overheating to damage your system.

▶ **GPIO Group Configuration**

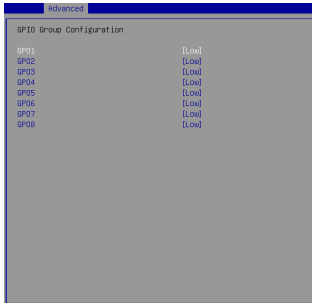

▶ **GP 01/ 02/ 03/ 04/ 05/ 06/ 07/ 08**

This setting controls the operation mode of the specified GPIO.

Boot

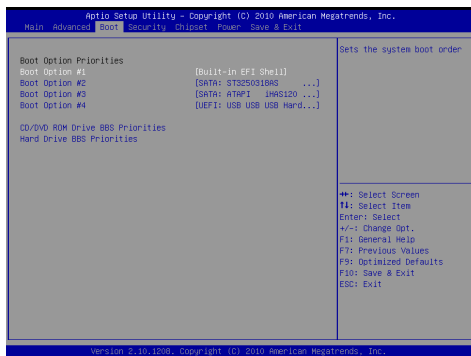

► Boot Option #1 / #2 / #3 / #4

This setting allows users to set the sequence of boot devices where BIOS attempts to load the disk operating system.

► CD/DVD ROM Drive BBS Priorities, Hard Drive BBS Priorities

This setting allows users to set the priority of the specified devices. First press <Enter> to enter the sub-menu. Then you may use the arrow keys (↑ ↓) to select the desired device, then press <+>, <-> or <PageUp>, <PageDown> key to move it up/down in the priority list.

Security

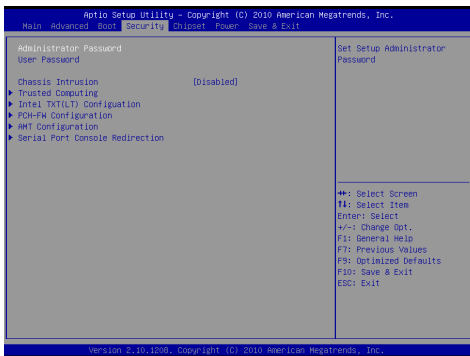

► Administrator Password

Administrator Password controls access to the BIOS Setup utility.

► User Password

User Password controls access to the system at boot and to the BIOS Setup utility.

► Chassis Intrusion

The field enables or disables the feature of recording the chassis intrusion status and issuing a warning message if the chassis is once opened. To clear the warning message, set the field to [Reset]. The setting of the field will automatically return to the default value later.

► Trusted Computing

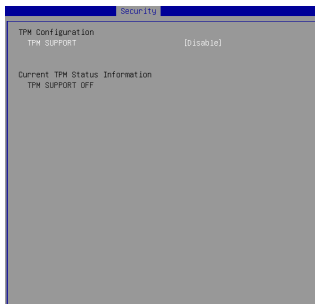

► TPM Support

This setting controls the Trusted Platform Module (TPM) designed by the Trusted Computing Group (TCG). TPMs are special-purpose integrated circuits (ICs) built into a variety of platforms to enable strong user authentication and machine attestation - essential to prevent inappropriate access to confidential and sensitive information and to protect against compromised networks.

► **Intel TXT(LT) Configuration**

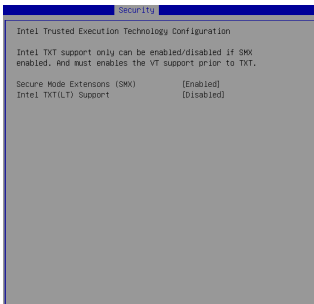

► **Secure Mode Extensions (SMX)**

This setting enables/disables the Secure Mode Extensions.

► **Intel TXT(LT) Support**

Intel TXT (Trusted Execution Technology) can only be enabled/disabled if SMX is enabled. VT and VT-d support must also be enabled prior to TXT.

► PCH-FW Configuration

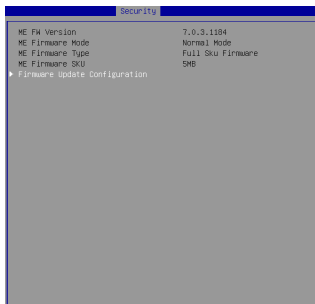

► ME FW Version, ME Firmware Mode/ Type/ Sku

These settings show the firmware information of the Intel ME (Management Engine).

► Firmware Update Configuration

Press [Enter] to view the firmware update configuration.

► **AMT Configuration**

Intel Active Management Technology (AMT) is hardware-based technology for remotely managing and securing PCs out-of-band.

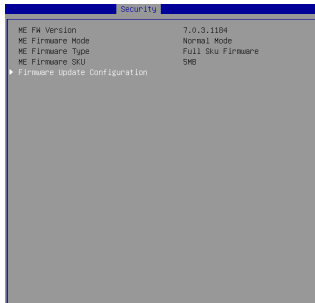

► Serial Port Console Redirection

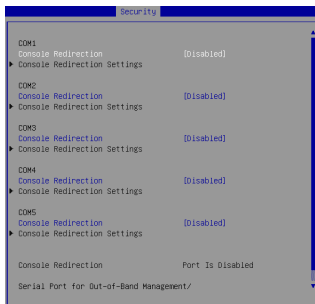

► Console Redirection

Console Redirection operates in host systems that do not have a monitor and keyboard attached. This setting enables/disables the operation of console redirection. When set to [Enabled], BIOS redirects and sends all contents that should be displayed on the screen to the serial COM port for display on the terminal screen. Besides, all data received from the serial port is interpreted as keystrokes from a local keyboard.

Chipset

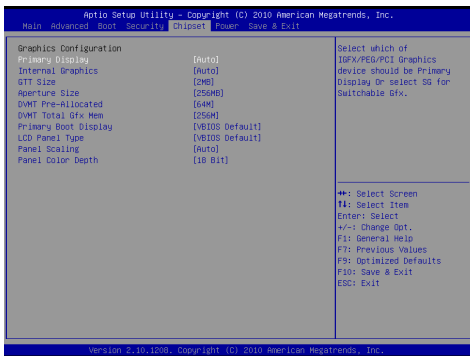

► Primary Display

This setting specifies which graphics device will be used as the primary display.

► Internal Graphics

This setting specifies the size of system memory allocated for video memory.

► GTT Size

This setting specifies the GTT size.

► Aperture Size

This setting controls just how much system RAM can be allocated for video purposes. The aperture is a portion of the PCI memory address range dedicated to graphics memory address space.

► DVMT Pre-Allocated, DVMT Total Gfx Mem

This setting specifies the memory size for DVMT.

► **Primary Boot Display**

Use the field to select the type of device you want to use as the boot display of the system.

► **LCD Panel Type, Panel Scaling, Panel Color Depth**

This setting allows you to set your preferences for the boot display device.

Power

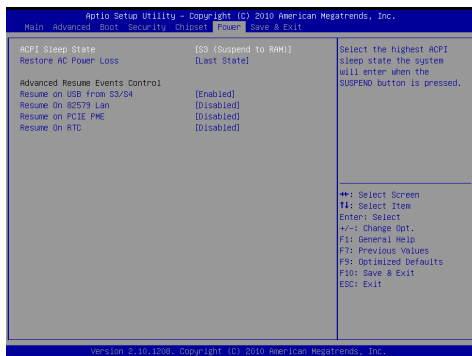

▶ ACPI Sleep State

This item specifies the power saving modes for ACPI function. If your operating system supports ACPI, you can choose to enter the Standby mode in S1 (POS) or S3 (STR) fashion through the setting of this field.

▶ Restore AC Power Loss

This setting specifies whether your system will reboot after a power failure or interrupt occurs. Available settings are:

[Power Off]	Leaves the computer in the power off state.
[Power On]	Leaves the computer in the power on state.
[Last State]	Restores the system to the previous status before power failure or interrupt occurred.

▶ Resume On USB from S3/S4

The item allows the activity of the USB device to wake up the system from S3/S4 sleep state.

▶ **Resume On 82579 LAN**

This field specifies whether the system will be awakened from power saving modes when activity or input signal of onboard LAN is detected.

▶ **Resume On PCIE PME**

This field specifies whether the system will be awakened from power saving modes when activity or input signal of onboard PCIE PME is detected.

▶ **Resume On RTC**

When [Enabled], you can set the date and time at which the RTC (real-time clock) alarm awakens the system from suspend mode.

Save & Exit

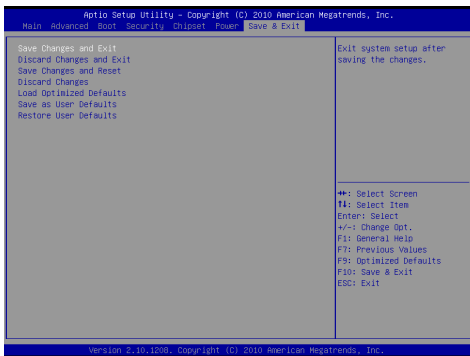

▶ **Save Changes and Exit**

Save changes to CMOS and exit the Setup Utility.

▶ **Discard Changes and Exit**

Abandon all changes and exit the Setup Utility.

▶ **Save Changes and Reset**

Save changes to CMOS and reset the system.

▶ **Discard Changes**

Abandon all changes and continue with the Setup Utility.

▶ **Load Optimized Defaults**

Load the optimized defaults.

▶ **Save as User Defaults**

Save all changes as user defaults.

▶ **Restore User Defaults**

Restore the preset user defaults.