

EPX-APLP

Intel® Celeron® Processor Apollo Lake Pico ITX
Motherboard

User's Manual



2nd Ed – 12 January 2018

FCC Statement



THIS DEVICE COMPLIES WITH PART 15 FCC RULES. OPERATION IS SUBJECT TO THE FOLLOWING TWO CONDITIONS:

(1) THIS DEVICE MAY NOT CAUSE HARMFUL INTERFERENCE.

(2) THIS DEVICE MUST ACCEPT ANY INTERFERENCE RECEIVED INCLUDING INTERFERENCE THAT MAY CAUSE UNDESIRE OPERATION.

THIS EQUIPMENT HAS BEEN TESTED AND FOUND TO COMPLY WITH THE LIMITS FOR A CLASS "A" DIGITAL DEVICE, PURSUANT TO PART 15 OF THE FCC RULES.

THESE LIMITS ARE DESIGNED TO PROVIDE REASONABLE PROTECTION AGAINST HARMFUL INTERFERENCE WHEN THE EQUIPMENT IS OPERATED IN A COMMERCIAL ENVIRONMENT. THIS EQUIPMENT GENERATES, USES, AND CAN RADIATE RADIO FREQUENCY ENERGY AND, IF NOT INSTALLED AND USED IN ACCORDANCE WITH THE INSTRUCTION MANUAL, MAY CAUSE HARMFUL INTERFERENCE TO RADIO COMMUNICATIONS.

OPERATION OF THIS EQUIPMENT IN A RESIDENTIAL AREA IS LIKELY TO CAUSE HARMFUL INTERFERENCE IN WHICH CASE THE USER WILL BE REQUIRED TO CORRECT THE INTERFERENCE AT HIS OWN EXPENSE.

Notice

This guide is designed for experienced users to setup the system within the shortest time. For detailed information, please always refer to the electronic user's manual.

Copyright Notice

Copyright © 2018 ALL RIGHTS RESERVED.

No part of this document may be reproduced, copied, translated, or transmitted in any form or by any means, electronic or mechanical, for any purpose, without the prior written permission of the original manufacturer.

Trademark Acknowledgement

Brand and product names are trademarks or registered trademarks of their respective owners.

Disclaimer

We reserve the right to make changes, without notice, to any product, including circuits and/or software described or contained in this manual in order to improve design and/or performance. We assume no responsibility or liability for the use of the described product(s), conveys no license or title under any patent, copyright, or masks work rights to these products, and makes no representations or warranties that

these products are free from patent, copyright, or mask work right infringement, unless otherwise specified. Applications that are described in this manual are for illustration purposes only. We make no representation or warranty that such application will be suitable for the specified use without further testing or modification.

Life Support Policy

OUR PRODUCTS ARE NOT FOR USE AS CRITICAL COMPONENTS IN LIFE SUPPORT DEVICES OR SYSTEMS WITHOUT THE PRIOR WRITTEN APPROVAL.

As used herein:

1. Life support devices or systems are devices or systems which, (a) are intended for surgical implant into body, or (b) support or sustain life and whose failure to perform, when properly used in accordance with instructions for use provided in the labeling, can be reasonably expected to result in significant injury to the user.
2. A critical component is any component of a life support device or system whose failure to perform can be reasonably expected to cause the failure of the life support device or system, or to affect its safety or effectiveness.

A Message to the Customer

Customer Services

Each and every product is built to the most exacting specifications to ensure reliable performance in the harsh and demanding conditions typical of industrial environments. Whether your new device is destined for the laboratory or the factory floor, you can be assured that your product will provide the reliability and ease of operation.

Your satisfaction is our primary concern. Here is a guide to our customer services. To ensure you get the full benefit of our services, please follow the instructions below carefully.

Technical Support

We want you to get the maximum performance from your products. So if you run into technical difficulties, we are here to help. For the most frequently asked questions, you can easily find answers in your product documentation. These answers are normally a lot more detailed than the ones we can give over the phone. So please consult the user's manual first.

EPX-APLP User's Manual

Product Warranty

We warrant to you, the original purchaser, that each of its products will be free from defects in materials and workmanship for two years from the date of purchase.

This warranty does not apply to any products which have been repaired or altered by persons other than repair personnel authorized, or which have been subject to misuse, abuse, accident or improper installation. We assume no liability under the terms of this warranty as a consequence of such events. Because of our high quality-control standards and rigorous testing, most of our customers never need to use our repair service. If any of our products is defective, it will be repaired or replaced at no charge during the warranty period. For out-of-warranty repairs, you will be billed according to the cost of replacement materials, service time, and freight. Please consult your dealer for more details. If you think you have a defective product, follow these steps:

1. Collect all the information about the problem encountered. (For example, CPU type and speed, our products model name, hardware & BIOS revision number, other hardware and software used, etc.) Note anything abnormal and list any on-screen messages you get when the problem occurs.
2. Call your dealer and describe the problem. Please have your manual, product, and any helpful information available.
3. If your product is diagnosed as defective, obtain an RMA (return material authorization) number from your dealer. This allows us to process your good return more quickly.
4. Carefully pack the defective product, a complete Repair and Replacement Order Card and a photocopy proof of purchase date (such as your sales receipt) in a shippable container. A product returned without proof of the purchase date is not eligible for warranty service.
5. Write the RMA number visibly on the outside of the package and ship it prepaid to your dealer.

Content

1. Getting Started	8
1.1 Safety Precautions.....	8
1.2 Packing List.....	8
1.3 Document Amendment History	9
1.4 Manual Objectives.....	10
1.5 System Specifications	11
1.6 Architecture Overview—Block Diagram	14
2. Hardware Configuration	15
2.1 Product Overview.....	16
2.2 Jumper and Connector List.....	17
2.3 Setting Jumpers & Connectors	19
2.3.1 Clear CMOS (CMOS1).....	19
2.3.2 AT/ATX Input power select (JSATX1).....	19
2.3.3 LCD Inverter connector (JBKL1)	20
2.3.4 Serial port 1 connector (COM1)	20
2.3.5 General purpose I/O connector (DIO1)	21
2.3.6 SATA Power header (SPWR1)	21
2.3.7 LVDS connector (LVDS1)	22
2.3.8 On-board header for USB2.0 (USB45)	23
2.3.9 On-board header for USB2.0 (USB67)	23
2.3.10 Low pin count interface (JLPC1).....	24
2.3.11 LPC power select (LPCP1)	24
2.3.12 Miscellaneous setting connector (FPT1)	25
2.3.13 Battery connector (BT1).....	25
2.3.14 SPI header (SPI1).....	26
2.3.15 Audio connector (FAUD1).....	26
2.3.15.1 Signal Description – Audio connector (FAUD1)	26
2.3.16 Speaker connector (SPK1)	27
3. BIOS Setup	28
3.1 Introduction	29
3.2 Starting Setup	29
3.3 Using Setup	30
3.4 Getting Help.....	31
3.5 In Case of Problems.....	31
3.6 BIOS setup.....	32
3.6.1 Main Menu.....	32

EPX-APLP User's Manual

3.6.1.1	System Language	33
3.6.1.2	System Date	33
3.6.1.3	System Time	33
3.6.2	Advanced Menu	33
3.6.2.1	Trusted Computing	34
3.6.2.2	APCI Settings.....	34
3.6.2.3	IT8528 Super IO Configuration.....	35
3.6.2.3.1	Serial Port 1 Configuration.....	36
3.6.2.4	H/W Monitor	36
3.6.2.5	S5 RTC Wake Settings.....	37
3.6.2.6	Serial Port Console Redirection.....	37
3.6.2.6.1	Legacy Console Redirection Settings.....	38
3.6.2.7	CPU Configuration	38
3.6.2.7.1	Socket 0 CPU Information	39
3.6.2.7.2	CPU Power Management Configuration	40
3.6.2.8	Network Stack Configuration	41
3.6.2.9	CSM Configuration	41
3.6.2.10	NVMe Configuration	42
3.6.2.11	USB Configuration	42
3.6.2.12	Security Configuration	43
3.6.3	Chipset.....	44
3.6.3.1	North Bridge.....	44
3.6.3.2	South Bridge	45
3.6.3.3	Uncore Configuration	45
3.6.3.4	South Cluster Configuration.....	47
3.6.3.4.1	HD-Audio Configuration	47
3.6.3.4.2	PCI Express Configuration	48
3.6.3.4.2.1	PCI Express Root Port 3(i210/211)	48
3.6.3.4.2.2	PCI Express Root Port 4(i210/211)	49
3.6.3.4.2.3	PCI Express Root Port 5(M.2 Key-B)	50
3.6.3.4.2.4	PCI Express Root Port 6(M.2 Key-A)	51
3.6.3.4.3	SATA Drivers	52
3.6.3.4.4	USB Configuration	53
3.6.4	Security.....	54
3.6.4.1	Secure Boot	55
3.6.5	Boot	56
3.6.6	Save and exit.....	57
3.6.6.1	Save Changes and Reset.....	57
3.6.6.2	Discard Changes and Reset.....	57
3.6.6.3	Restore Defaults	58

3.6.6.4	Launch EFI Shell from filesystem device.....	58
4.	Drivers Installation.....	59
4.1	Install Chipset Driver	60
4.2	Install TXE Driver	61
4.3	Install VGA Driver.....	62
4.4	Install Audio Driver	64
4.5	Install Ethernet Driver.....	65
4.6	Install Serial IO Driver	66
5.	Mechanical Drawing	67

1. Getting Started

1.1 Safety Precautions

Warning!



Always completely disconnect the power cord from your chassis whenever you work with the hardware. Do not make connections while the power is on. Sensitive electronic components can be damaged by sudden power surges. Only experienced electronics personnel should open the PC chassis.

Caution!



Always ground yourself to remove any static charge before touching the CPU card. Modern electronic devices are very sensitive to static electric charges. As a safety precaution, use a grounding wrist strap at all times. Place all electronic components in a static-dissipative surface or static-shielded bag when they are not in the chassis.

1.2 Packing List

Before you begin installing your single board, please make sure that the following materials have been shipped:

- 1 x EPX-APLP motherboard
- 1 x SATA cables
- 1 x SATA power cable
- 1 x Copper stud for M.2
- Optional: Thermal module heatsink solution:
 - 1 x Heatsink
 - 4 x Copper studs
 - 4 x Screws



If any of the above items is damaged or missing, contact your retailer.

1.3 Document Amendment History

Revision	Date	By	Comment
1 st	July 2017		Initial Release
2 nd	January 2018		Update System Specifications

1.4 Manual Objectives

This manual describes in details EPX-APLP Single Board.

We have tried to include as much information as possible but we have not duplicated information that is provided in the standard IBM Technical References, unless it proved to be necessary to aid in the understanding of this board.

We strongly recommend that you study this manual carefully before attempting to set up EPX-APLP or change the standard configurations. Whilst all the necessary information is available in this manual we would recommend that unless you are confident, you contact your supplier for guidance.

Please be aware that it is possible to create configurations within the CMOS RAM that make booting impossible. If this should happen, clear the CMOS settings, (see the description of the Jumper Settings for details).

If you have any suggestions or find any errors regarding this manual and want to inform us of these, please contact our Customer Service department with the relevant details.

1.5 System Specifications

System	
CPU	Apollo Lake** (Intel® Pentium® Processor)4C Apollo Lake** (Intel® Celeron® Processor)2C (Mobile and i series SKU)
BIOS	AMI uEFI BIOS, 128Mbit SPI Flash ROM
I/O Chip	EC IT8528VG
System Memory	One 204-pin DDR3L 1600 MHz SO-DIMM socket, supports up to 8GB Max
Watchdog Timer	H/W Reset, 1sec. – 65535sec./min.1sec. or 1min. step
EEPROM	AMI uEFI BIOS, 128Mbit SPI Flash ROM
H/W Status Monitor	CPU temperature monitoring Voltages monitoring
Expansion	1 x M.2 Type B 3042/2242/2260(with 1 x PCI-e x 1, USB 3.0, SATA Signal) 1 x M.2 Type A 2230 support WiFi module, 1 x PCI-e x 1, USB 2.0 Signal) *Micro SIM card to SIM card adapter by optional
S/S4	Yes (S0/S3/S4/S5)
I/O	
USB	2 x USB 3.0, 4 x USB 2.0
GPIO	8-bits GPIO
Display	
Chipset	Intel® Pentium®/ Celeron® SoC integrated Graphics
Resolution	1 x HDMI 1.4b: 3840 x 2160 @ 30 Hz, 2560 x 1600@ 30 Hz 1 x DP++: DisplayPort 1.2a : 4096x2160 @ 60Hz 2CH 18/24bits LVDS 1920 x 1080 (Chrontel. CH7511B eDP to LVDS Converter)
Multiple Display	Triple Display
HDMI	1 x DP++, 1 x HDMI
LCD Interface	Dual channel 18/24-bits LVDS (Chrontel CH7511B eDP to LVDS)
Audio	
AC97 Codec	Realtek ALC622 HD Audio Decoding Controller
Audio Amp	Realtek ALC105 Stereo Class-D 3W x 2
Ethernet	
LAN Chip	2 x Intel® I211AT PCI-e Gigabit Ethernet
Ethernet Interface	Gigabit Ethernet
Internal I/O Connectors	
Buzzer	Onboard by LED (Boot LED)
CMOS Battery	1 x horizontal type battery connector (Battery cable 170mm length)

EPX-APLP User's Manual

Power On	1 x 2 x 5 pin, pitch 2.00mm connector for front panel
Audio	1 x 1 x 10 pin, pitch 1.25mm connector for front Audio & 1 x 1 x 4 pin pitch 1.25mm connector For 3W Speaker
Internal I/O Connector	<p>Storage:</p> <ul style="list-style-type: none"> 1 x M.2 Type B 3042/2242/2260 (with 1 x PCI-e x 1, USB 3.0, SATA Signal) 1 x M.2 Type A 2230 support WiFi module, 1 x PCI-e x 1, USB 2.0 Signal) - 1 x SATA III - 1 x 1 x 2 pin, pitch 2.00mm connector for SATA power connectors 1 x 2 x 5 pin, pitch 2.00mm connector for RS-232(Ring/5V/12V By Resistance) 2 x 2 x 5 pin, pitch 2.00mm connector for 4 USB 2.0 1 x 2 x 6 pin, pitch 2.00mm connector for GPIO: 8bits 1 x 1 x 10 pin, pitch 1.00mm connector for BIOS SPI/EC 1 x 2 x 2 pin, pitch 2.0mm connector for LPC Power(5V & 12V & Ring) 1 x horizontal type battery connector (Battery cable 170mm length) 1 x 2 x 5 pin, pitch 2.0mm connector for front panel 1 x 2 x 20 pin, pitch 1.25mm connector for LVDS (must be using DF13-2S-1.25C connector) 1 x 1 x 5 pin, pitch 2.00mm Wafer connector for LCD inverter backlight connector (5V/12V) PWM/DC (By Resistance) 1 x 1 x 10 pin, pitch 1.25mm connector for front Audio & 1 x 1 x 4 pin pitch 1.25mm connector For 3W Speaker 1 x 3 pin, pitch 2.00mm connector for CMOS clear 1 x 1 x 3 pin, pitch 2.00mm connector for AT/ATX mode 1 x DC Jack lockable connector type Fanless Operating
Rear I/O Connectors	
USB	2 x USB3.0
LAN	2 x Intel® I211AT PCI-e Gigabit Ethernet
Display	1 x DP++, 1 x HDMI
Rear Side External I/O Connector	<ul style="list-style-type: none"> 2 x RJ-45 2 x USB 3.0 1 x HDMI 1 x DP++ 1 x DC Jack lockable connector type
Mechanical & Environmental	
Power Requirement	DC in +12V
ACPI	Single power ATX Support S0, S3, S4, S5

	ACPI 3.0 Compliant
Power Type	AT/ATX mode Switchable Through Jumper
Operating Temp.	-5 ~ 60°C (23 ~ 140°F)
Storage Temp.	-40°C ~ 75°C
Operating Humidity	0% ~ 90% relative humidity, non-condensing
Size (L x W)	3.937" x 2.834" (100mm x 72mm)
Weight	0.40 kg
OS support	Win10 (listed in accordance with Intel document)



Note: Specifications are subject to change without notice.

1.6 Architecture Overview—Block Diagram

The following block diagram shows the architecture and main components of EPX-APLP.

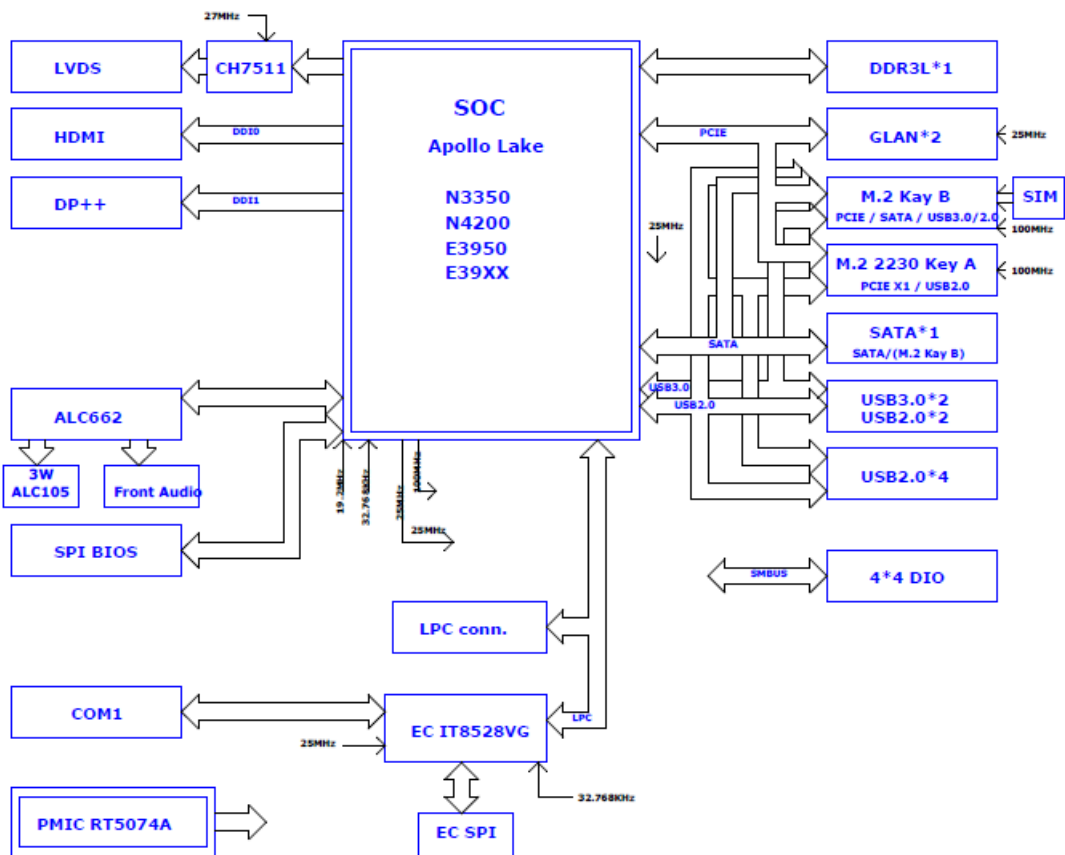

2. Hardware Configuration

2.1 Product Overview

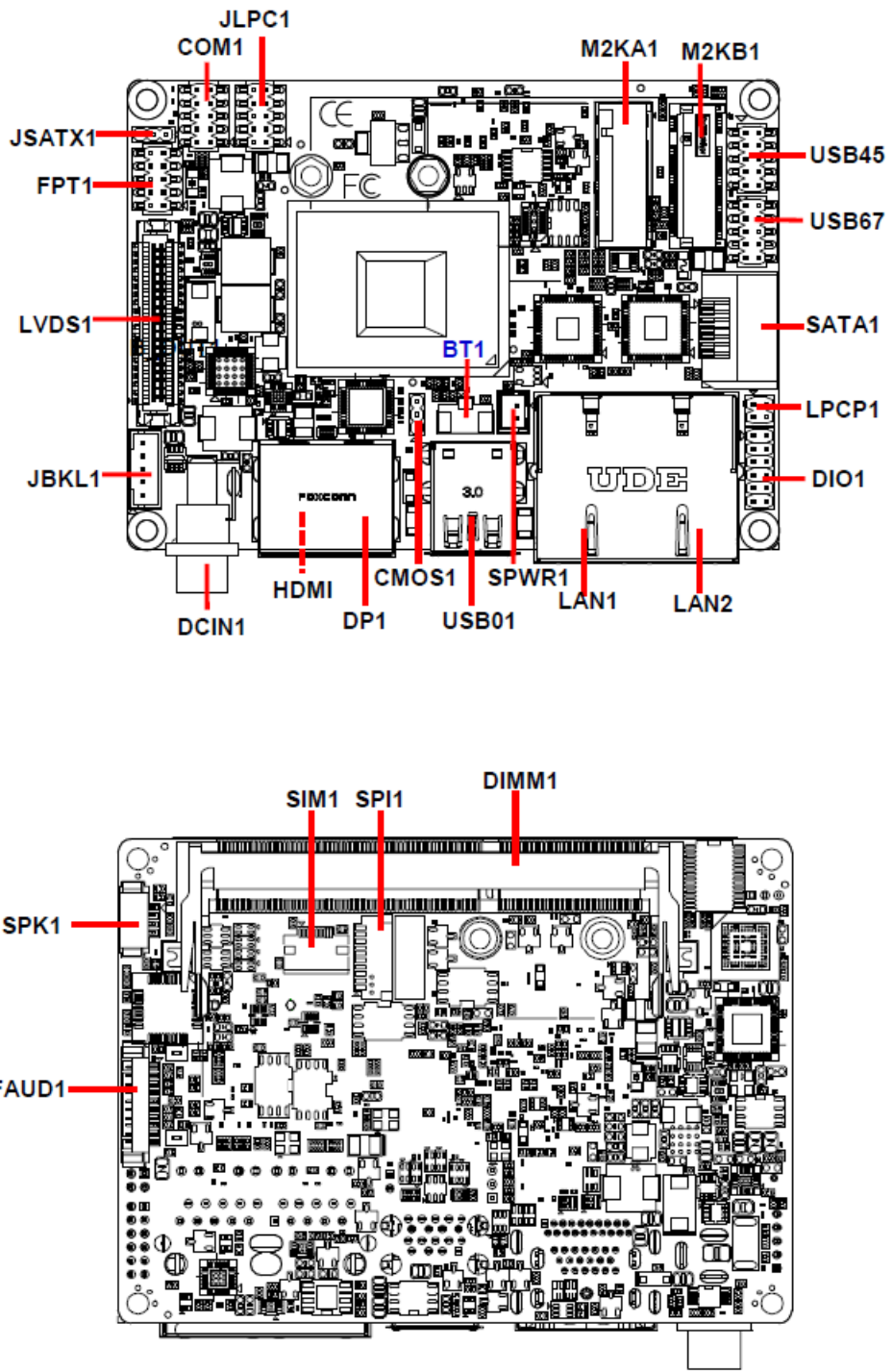

2.2 Jumper and Connector List

You can configure your board to match the needs of your application by setting jumpers. A jumper is the simplest kind of electric switch.

It consists of two metal pins and a small metal clip (often protected by a plastic cover) that slides over the pins to connect them. To “close” a jumper you connect the pins with the clip. To “open” a jumper you remove the clip. Sometimes a jumper will have three pins, labeled 1, 2, and 3. In this case, you would connect either two pins.

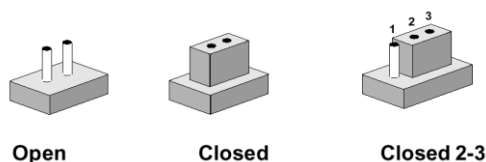

The jumper settings are schematically depicted in this manual as follows:



A pair of needle-nose pliers may be helpful when working with jumpers.

Connectors on the board are linked to external devices such as hard disk drives, a keyboard, or floppy drives. In addition, the board has a number of jumpers that allow you to configure your system to suit your application.

If you have any doubts about the best hardware configuration for your application, contact your local distributor or sales representative before you make any changes.

The following tables list the function of each of the board's jumpers and connectors.

Jumpers

Label	Function	Note
CMOS1	Clear CMOS	3 x 1 header, pitch 2.00 mm
JSATX1	AT/ATX Input power select	3 x 1 header, pitch 2.00 mm

Connectors

Label	Function	Note
BT1	Battery connector	2 x 1 wafer, pitch 1.25 mm
FPT1	Miscellaneous setting connector	5 x 2 header, pitch 2.00 mm
DCIN1	DC Power-in connector	
JBKL1	LCD inverter connector	5 x 1 wafer, pitch 2.00 mm
DP1	DP connector	
COM1	Serial port 1 connector	5 x 2 header, pitch 2.00 mm

EPX-APLP User's Manual

LPCP1	LPC power select	2 x 2 header, pitch 2.00 mm
DIO1	General purpose I/O connector	6 x 2 header, pitch 2.00 mm
JLPC1	Low pin count interface	5 x 2 header, pitch 2.00 mm
LVDS1	LVDS connector	20 x 2 wafer, pitch 1.25 mm
USB01	On-board connector for USB3.0 x 2	
USB45	On-board header for USB2.0	5 x 2 header, pitch 2.00 mm
USB67	On-board header for USB2.0	5 x 2 header, pitch 2.00 mm
LAN1/2	RJ-45 Ethernet connector 1/2	
M2KA1	M.2 Type A 2230 connector	
M2KB1	M.2 Type B 3042/2242/2260 connector	
SPWR1	SATA power header	2 x 1 wafer, pitch 2.00 mm
SATA1	Serial ATA connector 1	
HDMI	HDMI connector	
NGFF1	M.2 B key slot	
SPK1	Speaker connector	1 x 4 wafer, pitch 1.25 mm
DIMM1	204-pin DDR3L DIMM socket	
SPI1	SPI connector	10 x 1 wafer, pitch 1.00 mm
AUD1	Audio connector	10 x 1 wafer, pitch 1.25 mm
SIM1	Micro SIM slot	Micro SIM card to SIM card adapter by optional

2.3 Setting Jumpers & Connectors

2.3.1 Clear CMOS (CMOS1)

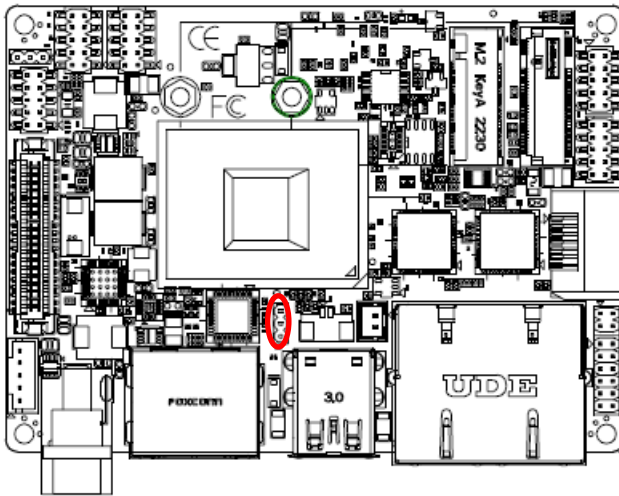

Protect*

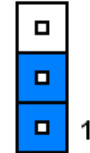

Clear CMOS

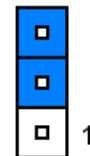

* Default

2.3.2 AT/ATX Input power select (JSATX1)

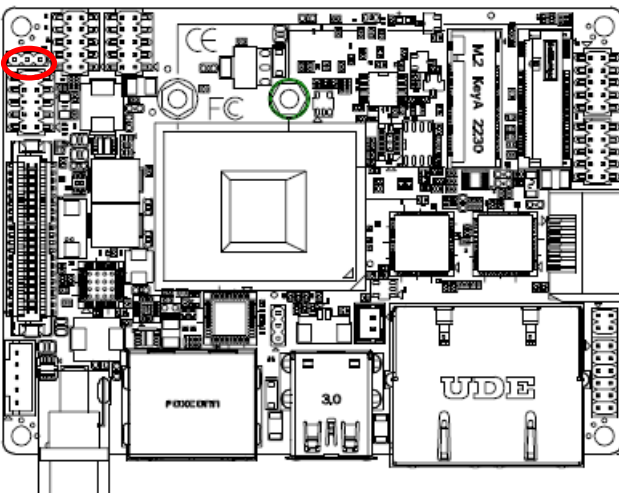

ATX*

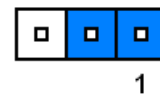

AT

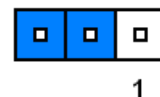

* Default

2.3.3 LCD Inverter connector (JBKL1)

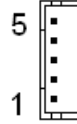
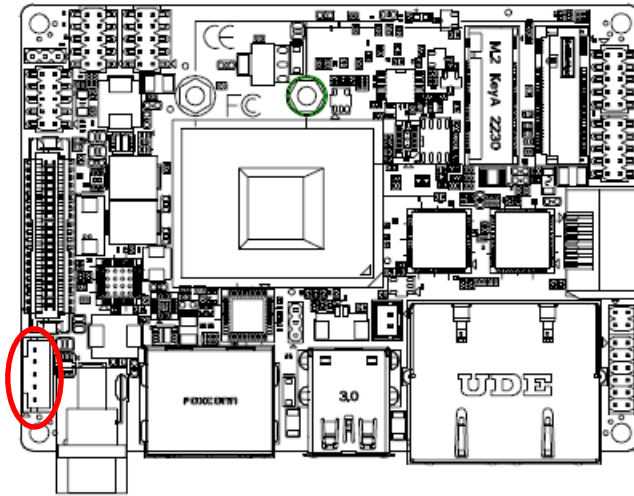

Signal	PIN
+5V	5
LVDS_BKLADJ	4
LVDS_BKLTEN	3
GND	2
+12V	1

2.3.4 Serial port 1 connector (COM1)

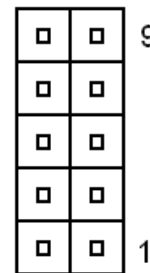
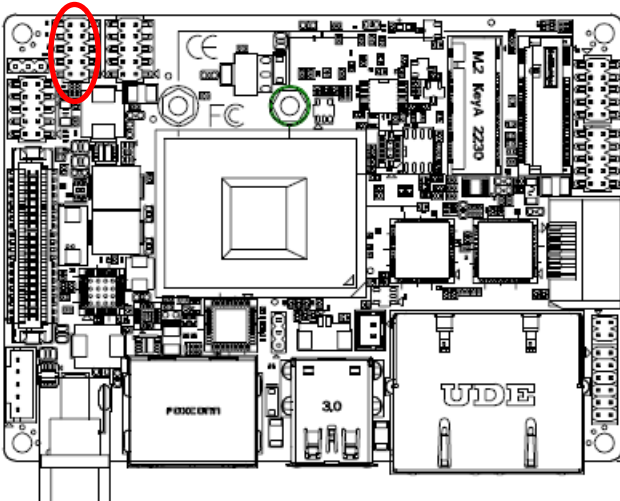

Signal	PIN	PIN	Signal
NC	10	9	RI
CTS	8	7	RTS
DSR	6	5	GND
DTR	4	3	TXD
RXD	2	1	DCD

2.3.5 General purpose I/O connector (DIO1)

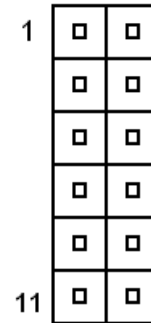
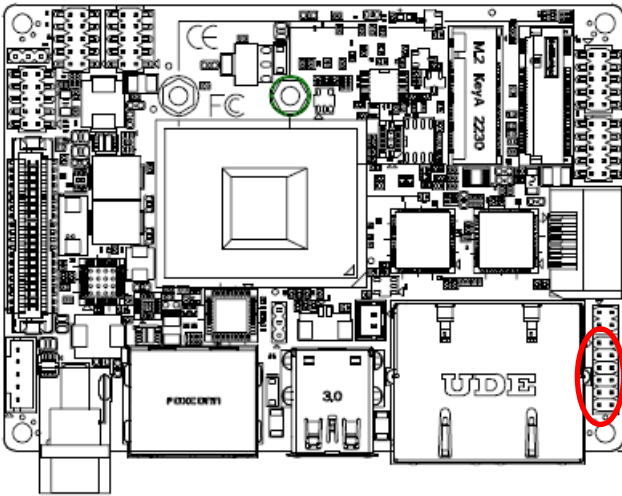

Signal	PIN	PIN	Signal
DI0	1	2	DO0
DI1	3	4	DO1
DI2	5	6	DO2
DI3	7	8	DO3
SMB_CLK	9	10	SMB_DATA
GND	11	12	+5V

2.3.6 SATA Power header (SPWR1)

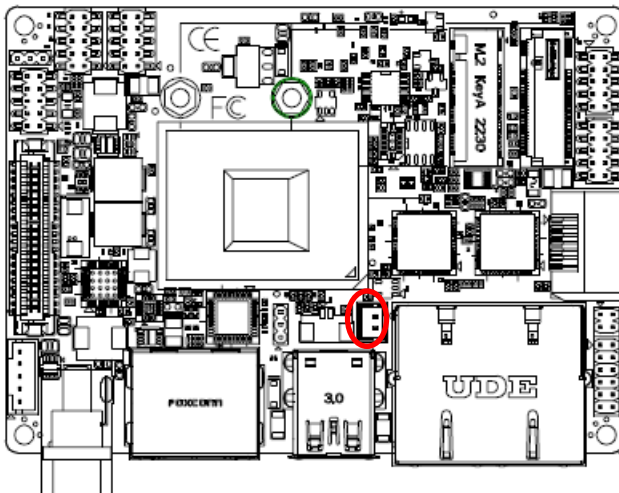

Signal	PIN
GND	1
+5V	2

2.3.7 LVDS connector (LVDS1)

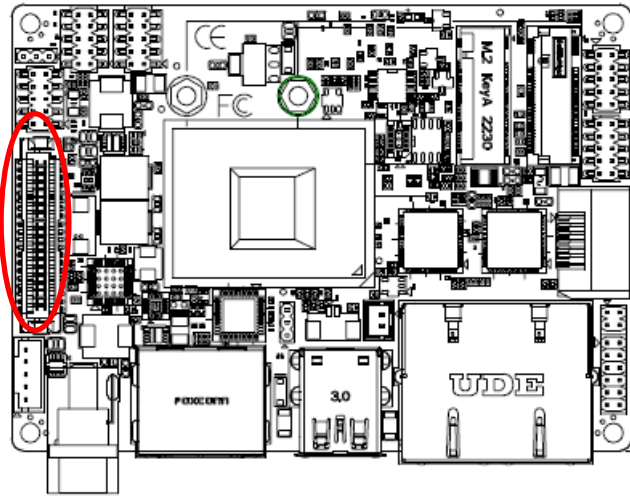

Signal	PIN	PIN	Signal
+12V	39	40	+12V
GND	37	38	GND
LVDS_CLK2N	35	36	LVDS_CLK1N
LVDS_CLK2P	33	34	LVDS_CLK1P
GND	31	32	GND
LVDS_DATAN7	29	30	LVDS_DATAN6
LVDS_DATAP7	27	28	LVDS_DATAP6
GND	25	26	GND
LVDS_DATAN5	23	24	LVDS_DATAN4
LVDS_DATAP5	21	22	LVDS_DATAP4
GND	19	20	GND
LVDS_DATAN3	17	18	LVDS_DATAN2
LVDS_DATAP3	15	16	LVDS_DATAP2
GND	13	14	GND
LVDS_DATAN1	11	12	LVDS_DATAN0
LVDS_DATAP1	9	10	LVDS_DATAP0
GND	7	8	GND
NC	5	6	NC
+3.3V	3	4	+5V
+3.3V	1	2	+5V

2.3.8 On-board header for USB2.0 (USB45)

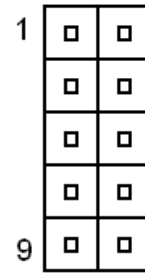
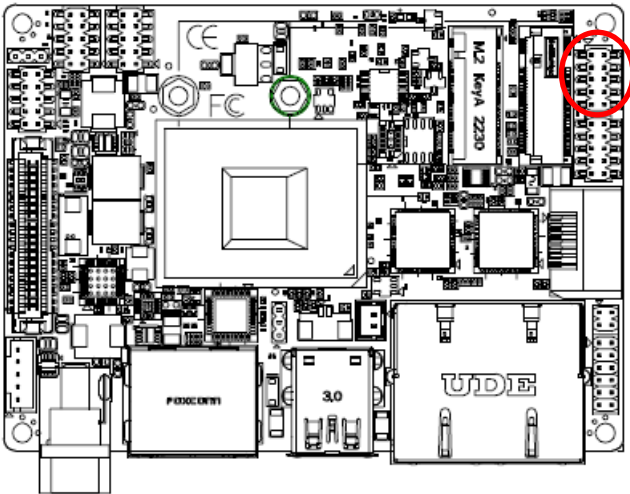

Signal	PIN	PIN	Signal
+5VSB	1	2	+5VSB
USB_DN4	3	4	USB_DN5
USB_DP4	5	6	USB_DP5
GND	7	8	GND
NC	9	10	NC

2.3.9 On-board header for USB2.0 (USB67)

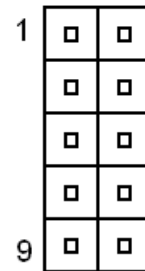
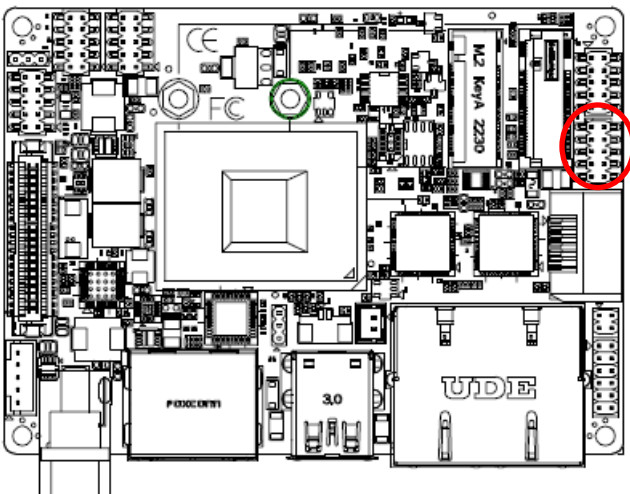

Signal	PIN	PIN	Signal
+5VSB	1	2	+5VSB
USB_DN6	3	4	USB_DN7
USB_DP6	5	6	USB_DP7
GND	7	8	GND
NC	9	10	NC

2.3.10 Low pin count interface (JLPC1)

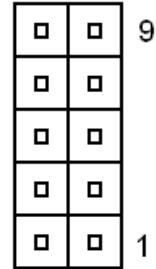
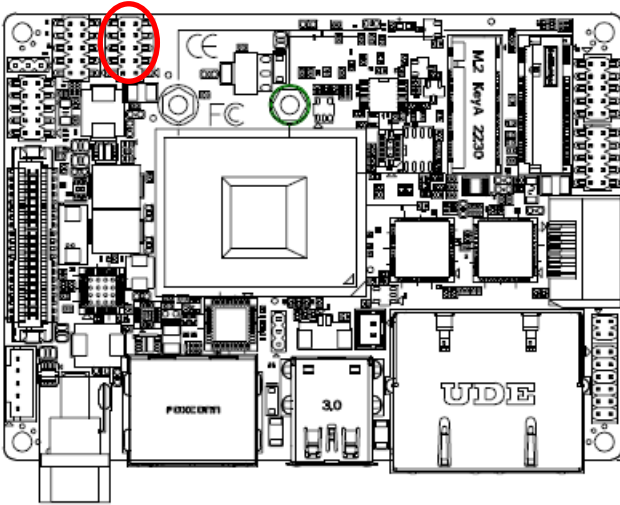

Signal	PIN	PIN	Signal
GND	10	9	LPC_SERIRQ
LPC_CLK_DEB	8	7	LPC_AD3
LPC_FRAME#	6	5	LPC_AD2
PLT_RST#	4	3	LPC_AD1
+3.3V	2	1	LPC_AD0

2.3.11 LPC power select (LPCP1)

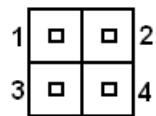
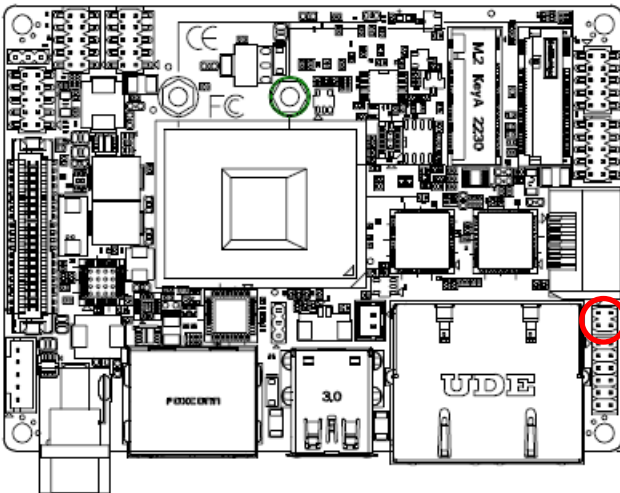

Signal	PIN	PIN	Signal
+5V	1	2	+12V
JNRIB#	3	4	GND

2.3.12 Miscellaneous setting connector (FPT1)

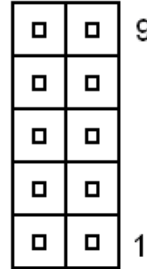
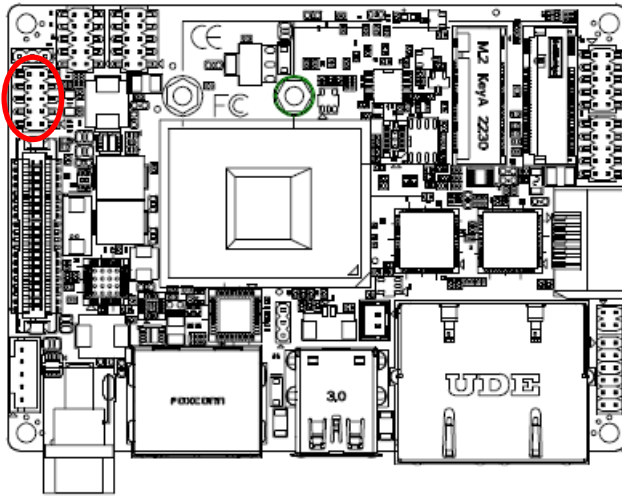

Signal	PIN
+HD-LED	1
+PWR-LED	2
-HD-LED	3
-PWR-LED	4
+Reset	5
+PWR_BNT	6
-Reset	7
-PWR_BNT	8

2.3.13 Battery connector (BT1)

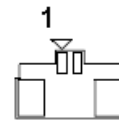
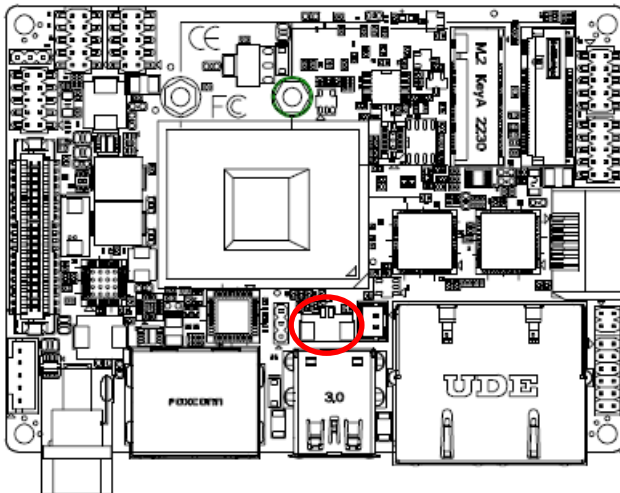

Signal	PIN
+3.3VSB	1
GND	2

2.3.14 SPI header (SPI1)

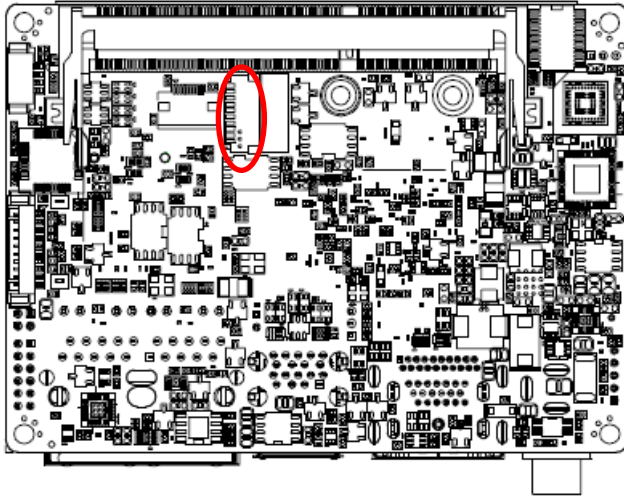

Signal	PIN
+1.8VSB	10
GND	9
SPI_CS0#	8
SPI_CLK	7
SPI_MISO	6
SPI_MOSI	5
SPI_HOLD#	4
NC	3
EC_SMBCLK	2
EC_SMBDATA	1

2.3.15 Audio connector (FAUD1)

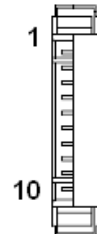
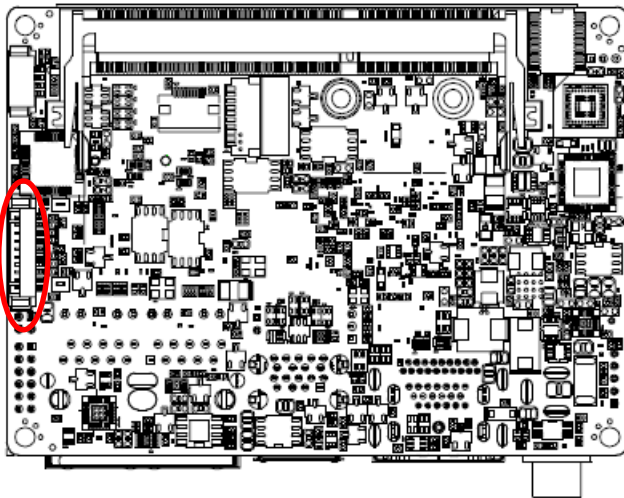

Signal	PIN
MIC2_L	1
GND	2
MIC2_R	3
AUD_FRONT_DET	4
LINE2_R	5
MIC2_JD	6
SENSE_B	7
NC	8
LINE2_L	9
LINE2_JD	10

2.3.15.1 Signal Description – Audio connector (FAUD1)

Signal	Signal Description
LINE2_JD	AUDIO IN (LINE_RIN/LIN)sense pin
AUD_FRONT_DET	AUDIO Out(ROUT/LOUT) sense pin
MIC2_JD	MIC IN (MIC_RIN/LIN) sense pin

2.3.16 Speaker connector (SPK1)

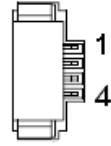
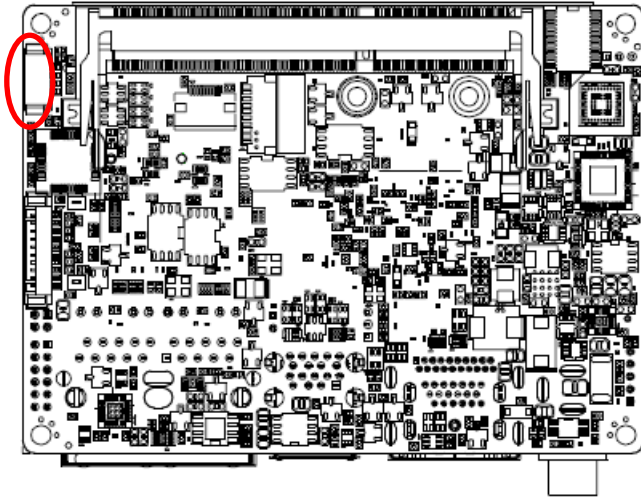

Signal	PIN
LSPK+	1
LSPK-	2
RSPK+	3
RSPK-	4

3. BIOS Setup

3.1 Introduction

The BIOS setup program allows users to modify the basic system configuration. In this following chapter will describe how to access the BIOS setup program and the configuration options that may be changed.

3.2 Starting Setup

AMI BIOS™ is immediately activated when you first power on the computer. The BIOS reads the system information contained in the NVRAM and begins the process of checking out the system and configuring it. When it finishes, the BIOS will seek an operating system on one of the disks and then launch and turn control over to the operating system.

While the BIOS is in control, the Setup program can be activated in one of two ways:

By pressing or <ESC> immediately after switching the system on, or

By pressing the or <ESC> key when the following message appears briefly at the left-top of the screen during the POST (Power On Self Test).

Press or <ESC> to enter SETUP

If the message disappears before you respond and you still wish to enter Setup, restart the system to try again by turning it OFF then ON or pressing the "RESET" button on the system case. You may also restart by simultaneously pressing <Ctrl>, <Alt>, and <Delete> keys.

3.3 Using Setup

In general, you use the arrow keys to highlight items, press <Enter> to select, use the PageUp and PageDown keys to change entries, press <F1> for help and press <Esc> to quit. The following table provides more detail about how to navigate in the Setup program using the keyboard.

Button	Description
↑↓→←	Move
Enter	Select
+/-	Value
ESC	Exit
F1 key	General Help
F2 key	Previous Values
F3 key	Optimized Defaults
F4 key	Save & Exit Setup
<K>	Scroll help area upwards
<M>	Scroll help area downwards

- **Navigating Through The Menu Bar**

Use the left and right arrow keys to choose the menu you want to be in.



Note: Some of the navigation keys differ from one screen to another.

- **To Display a Sub Menu**

Use the arrow keys to move the cursor to the sub menu you want. Then press <Enter>. A “➤” pointer marks all sub menus.

3.4 Getting Help

Press F1 to pop up a small help window that describes the appropriate keys to use and the possible selections for the highlighted item. To exit the Help Window press <Esc> or <Enter> key.

3.5 In Case of Problems

If, after making and saving system changes with Setup, you discover that your computer no longer is able to boot, the AMI BIOS supports an override to the NVRAM settings which resets your system to its defaults.

The best advice is to only alter settings which you thoroughly understand. To this end, we strongly recommend that you avoid making any changes to the chipset defaults. These defaults have been carefully chosen by both BIOS Vendor and your systems manufacturer to provide the absolute maximum performance and reliability. Even a seemingly small change to the chipset setup has the potential for causing you to use the override.

EPX-APLP User's Manual

3.6 BIOS setup

Once you enter the Aptio Setup Utility, the Main Menu will appear on the screen. The Main Menu allows you to select from several setup functions and exit choices. Use the arrow keys to select among the items and press <Enter> to accept and enter the sub-menu.

3.6.1 Main Menu

This section allows you to record some basic hardware configurations in your computer and set the system clock.

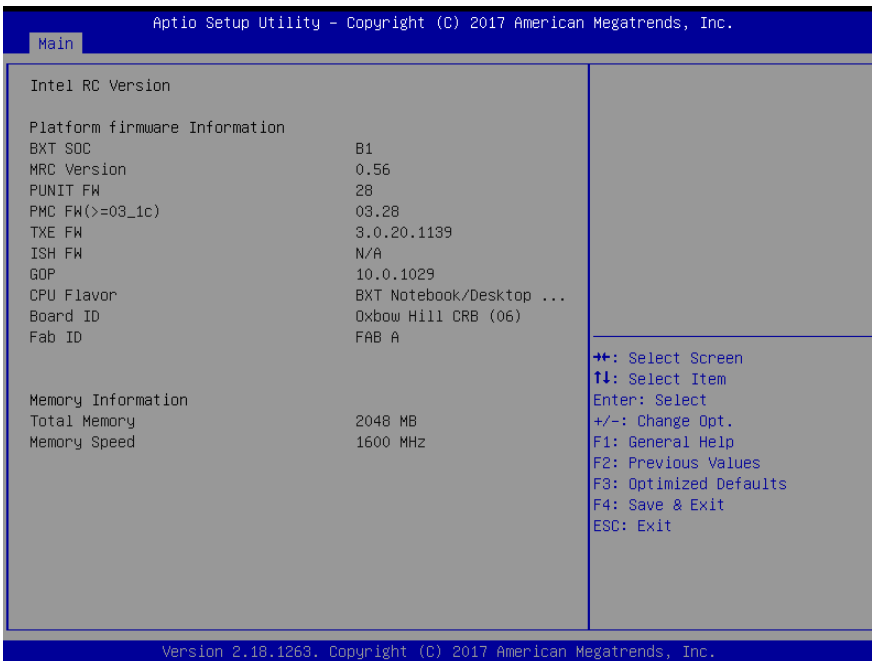

3.6.1.1 System Language

This option allows choosing the system default language.

3.6.1.2 System Date

Use the system date option to set the system date. Manually enter the day, month and year.

3.6.1.3 System Time

Use the system time option to set the system time. Manually enter the hours, minutes and seconds.



Note: The BIOS setup screens shown in this chapter are for reference purposes only, and may not exactly match what you see on your screen.

3.6.2 Advanced Menu

This section allows you to configure your CPU and other system devices for basic operation through the following sub-menus.

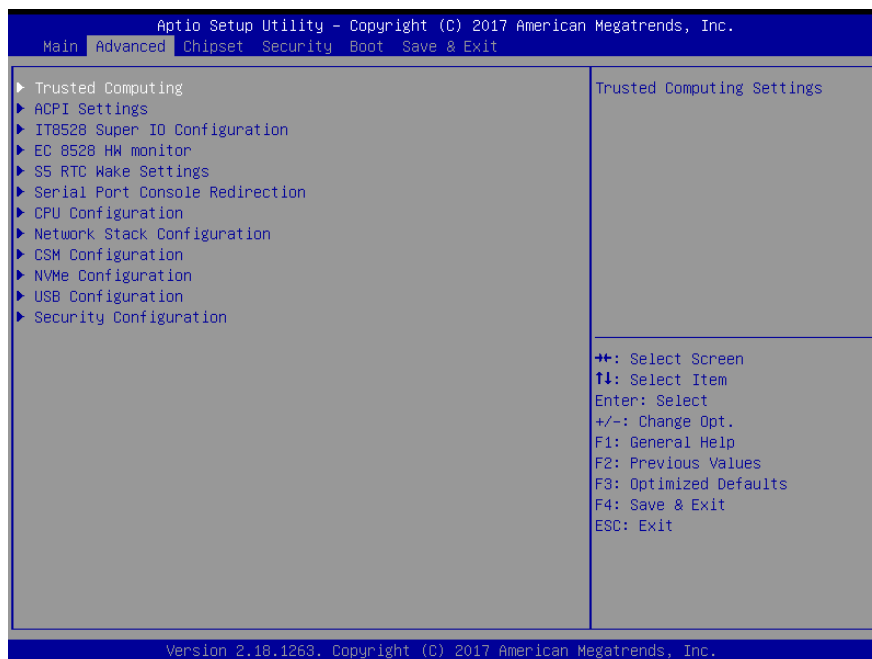

3.6.2.1 Trusted Computing



Item	Options	Description
Security Device Support	Disable, Enable[Default]	Enables or Disables BIOS support for security device. O.S. will not show Security Device. TCG EFI protocol and INT1A interface will not be available.

3.6.2.2 APCI Settings

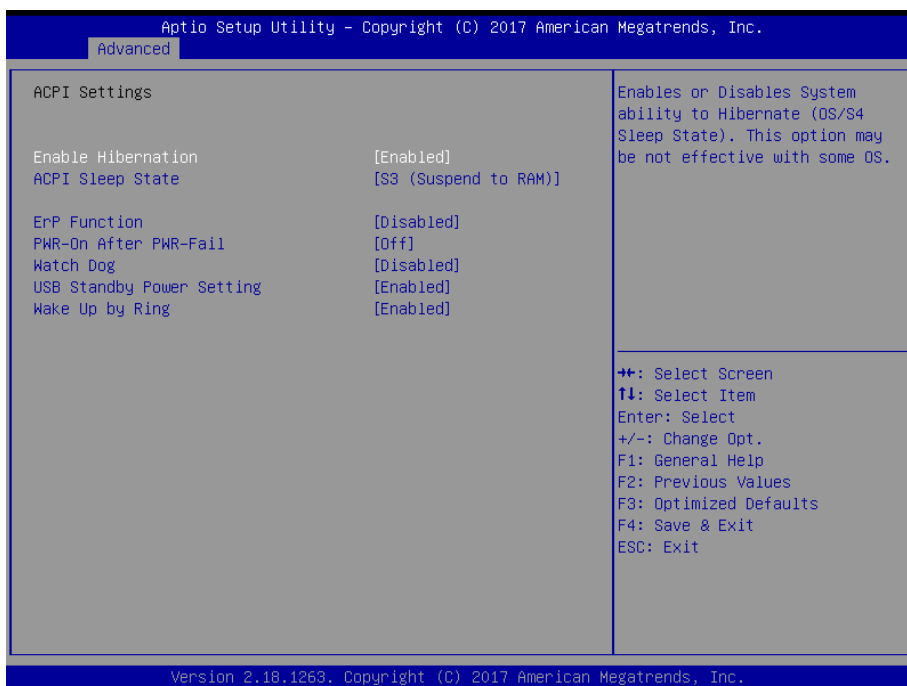

Item	Options	Description
Enable Hibernation	Disabled Enabled[Default]	Enables or Disables System ability to Hibernate (OS/S4 Sleep State). This option may be not effective with some OS.
ACPI Sleep State	Suspend Disabled, S3 (Suspend to RAM) [Default]	Select the highest ACPI sleep state the system will enter when the SUSPEND button is pressed.
ErP Function	Disabled[Default], Enabled	ErP Function (Deep S5).
Pwr-On After PWR-Fail	Off[Default] On Last state	AC loss resume.
Watch Dog	Disabled[Default], 30 sec 40 sec 50 sec 1 min 2 min 10 min 30 min	Select WatchDog.
USB Standby Power Setting	Disabled Enabled[Default]	Enabled/Disabled USB Standby Power during S3/S4/S5.
Wake Up By Ring	Disabled Enabled[Default]	Wake Up by Ring from S3/S4/S5.

3.6.2.3 IT8528 Super IO Configuration

You can use this item to set up or change the IT8528 Super IO configuration for serial ports. Please refer to 3.6.2.3.1 for more information.

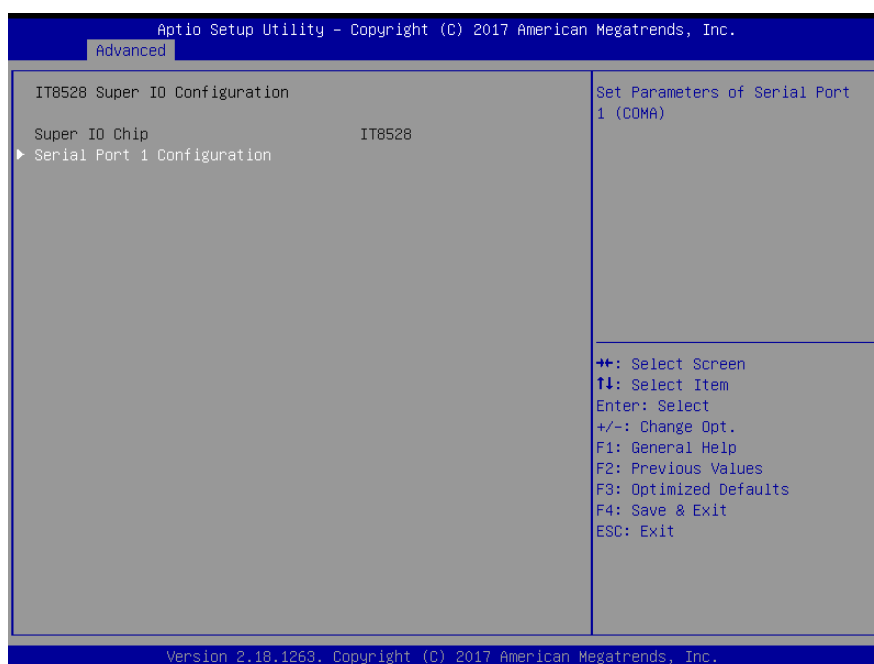

EPX-APLP User's Manual

Item	Description
Serial Port 1 Configuration	Set Parameters of Serial Port 1 (COMA).

3.6.2.3.1 Serial Port 1 Configuration

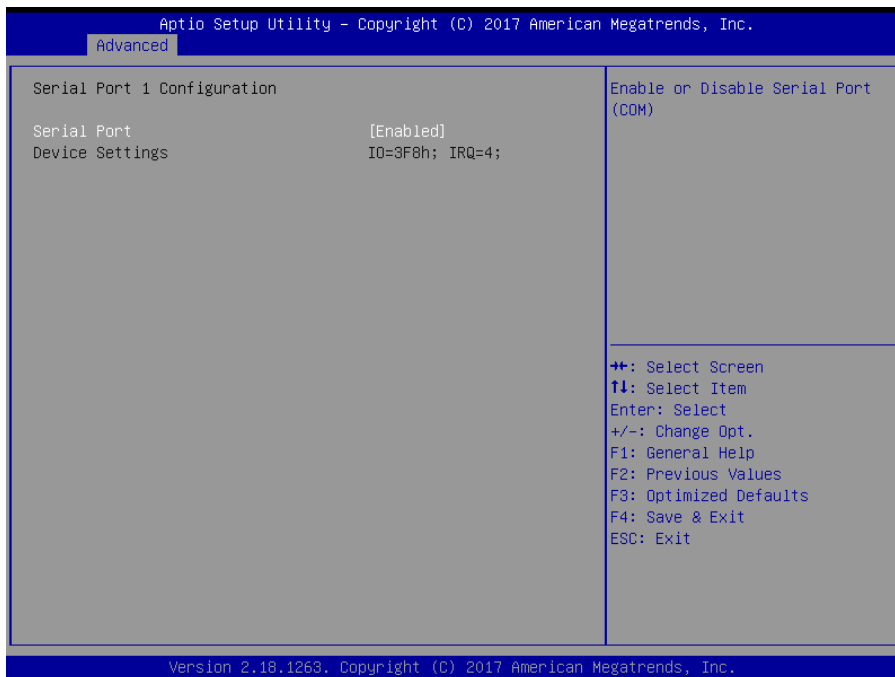

Item	Option	Description
Serial Port	Disabled Enabled[Default]	Enable or Disable Serial Port (COM).

3.6.2.4 H/W Monitor

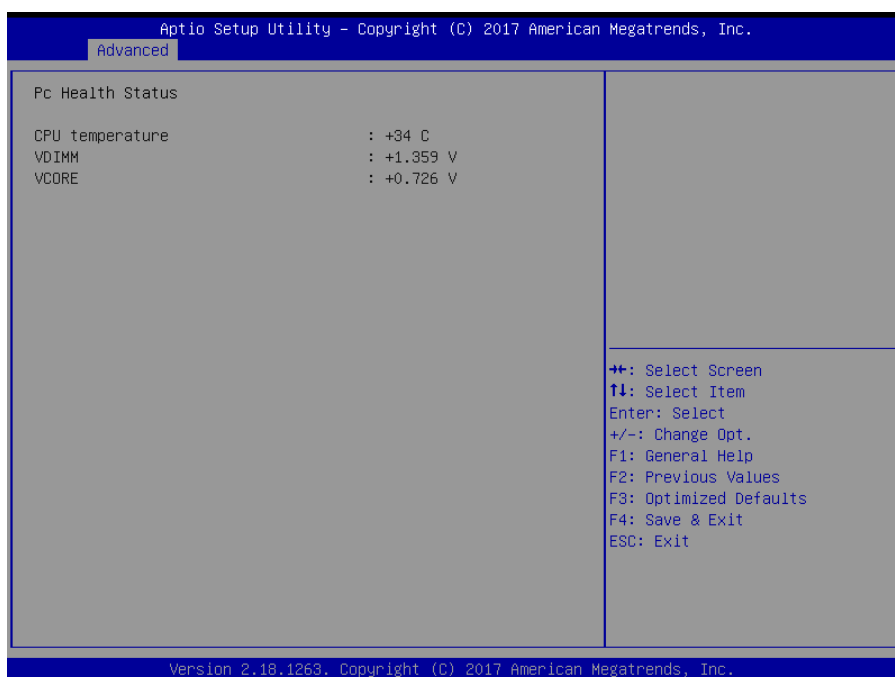

3.6.2.5 S5 RTC Wake Settings



Item	Options	Description
Wake system from S5	Disabled[Default], Fixed Time Dynamic Time	Enable or disable System wake on alarm event. Select Fixed Time, system will wake on the hr::min::sec specified. Select Dynamic Time, System will wake on the current time + Increase minute(s).

3.6.2.6 Serial Port Console Redirection

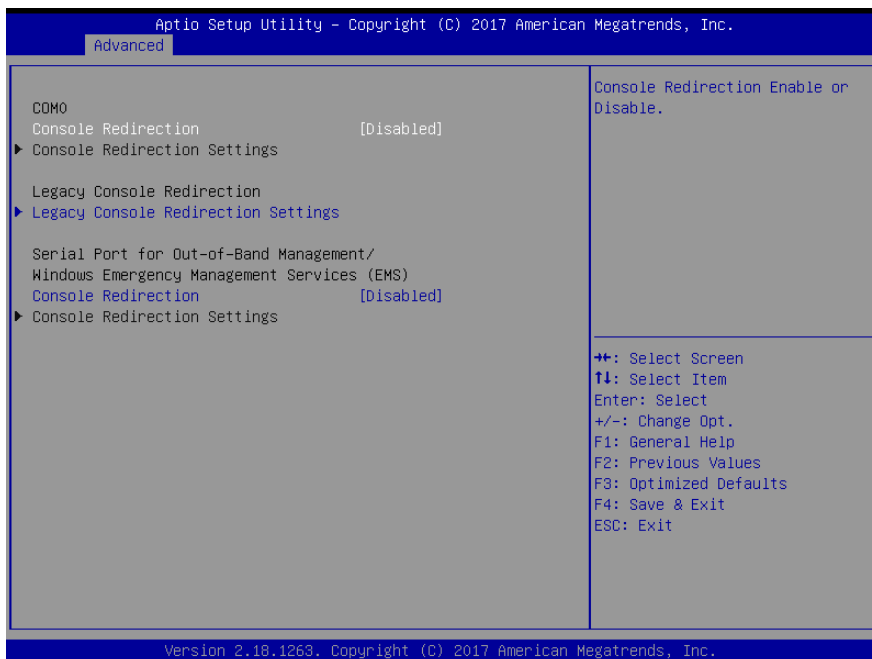

Item	Options	Description
Console Redirection	Disabled[Default], Enabled	Console Redirection Enable or Disable.

3.6.2.6.1 Legacy Console Redirection Settings

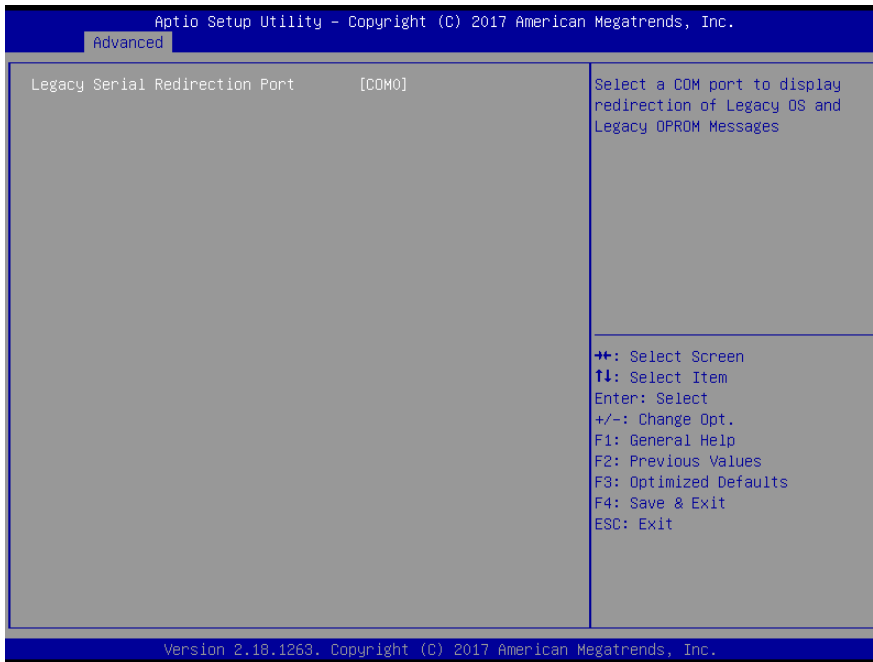

Item	Option	Description
Legacy Serial Redirection Port	COM0[Default]	Select a COM port to display redirection of Legacy OS and Legacy OPRM Messages.

3.6.2.7 CPU Configuration

Use the CPU configuration menu to view detailed CPU specification and configure the CPU.

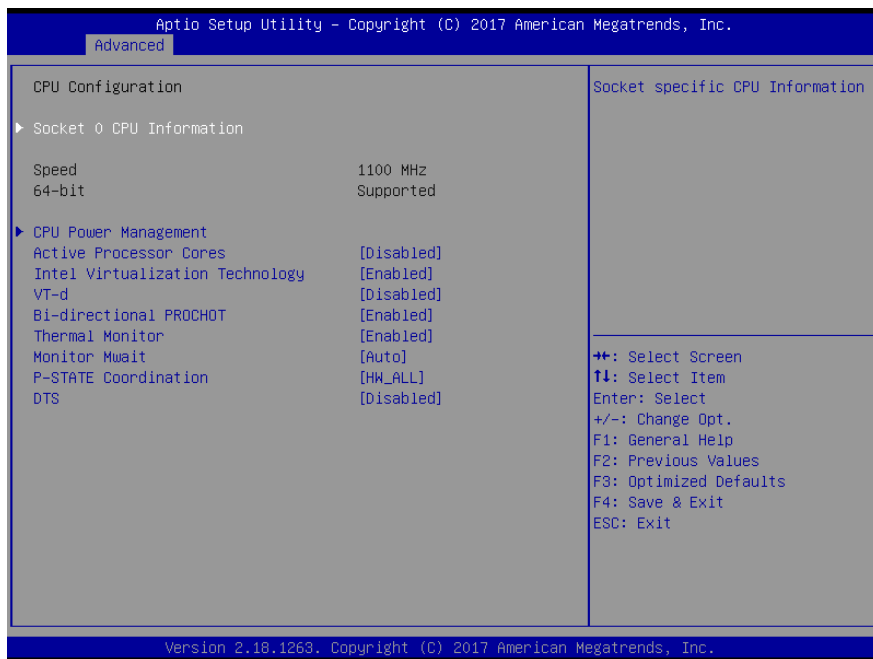

Item	Options	Description
Active Processor Cores	Disabled[Default]	Number of cores to enable in each

	Enabled	processor package.
Intel Virtualization Technology	Disabled Enabled[Default]	When enabled, a VMM can utilize the additional hardware capabilities provided by Vanderpool Technology.
VT-d	Disabled[Default] Enabled	Enable/Disable CPU VT-d.
Bi-directional PROCHOT	Disabled Enabled[Default]	When a processor thermal sensor trips (either core), the PROCHOT# will be driven. If bi-direction is enabled, external agents can drive PROCHOT# to throttle the processor.
Thermal Monitor	Disabled Enabled[Default]	Enable/Disable Thermal Monitor.
Monitor Mwait	Disabled Enabled Auto[Default]	Enable/Disable Monitor Mwait.
P-STATE Coordination	HW_ALL[Default] SW_ALL SW_ANY	Change P-STATE Coordination type.
DTS	Disabled[Default] Enabled	Enable/Disable Digital Thermal Sensor.

3.6.2.7.1 Socket 0 CPU Information

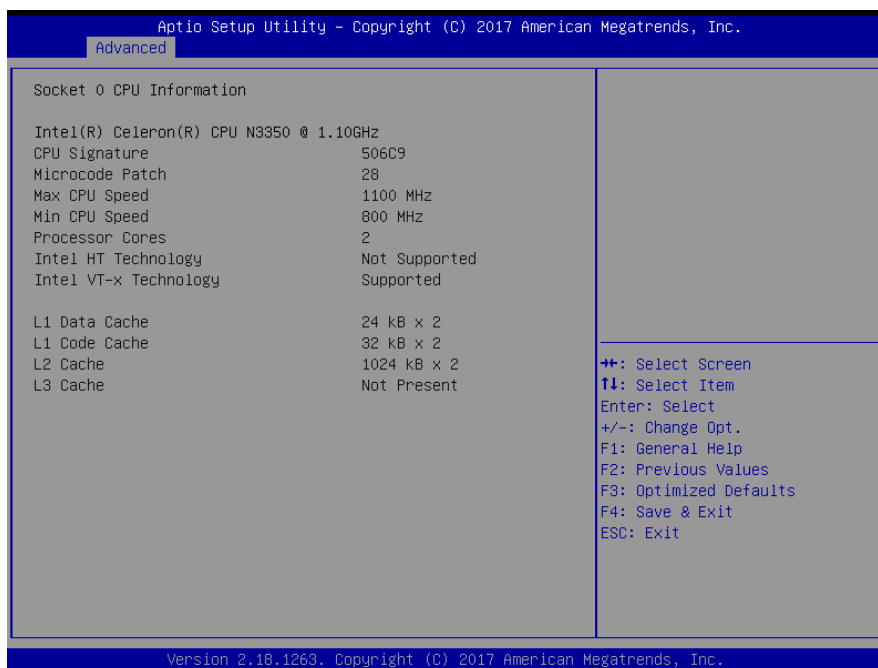

3.6.2.7.2 CPU Power Management Configuration

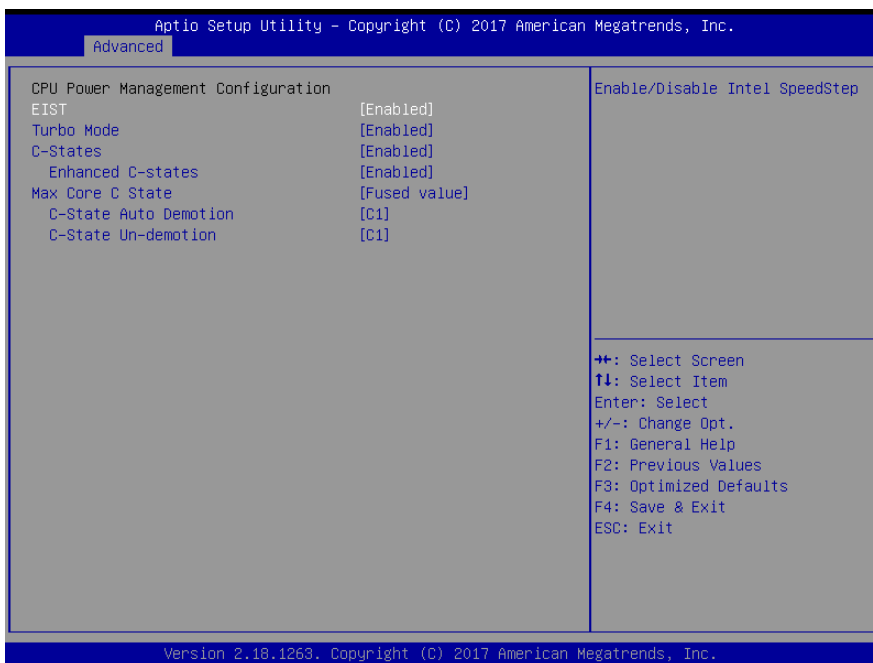

Item	Option	Description
EIST	Disabled Enabled[Default]	Enable/Disable Intel SpeedStep.
Turbo Mode	Disabled Enabled[Default]	Turbo Mode.
C-States	Disabled Enabled[Default]	Enable/Disable C States.
Enhanced C-states	Disabled Enabled[Default]	Enable/Disable C1E. When enabled, CPU will switch to minimum speed when all cores enter C-State.
Max Core C State	Fused value[Default] Core C10 Core C9 Core C8 Core C7 Core C6 Core C1 Unlimited	This option controls the Max Core C State that cores will support.
C-State Auto Demotion	Disabled C1[Default]	Configure C-State Auto Demotion.
C-State Un-demotion	Disabled C1[Default]	Configure C-State Un-demotion.

3.6.2.8 Network Stack Configuration

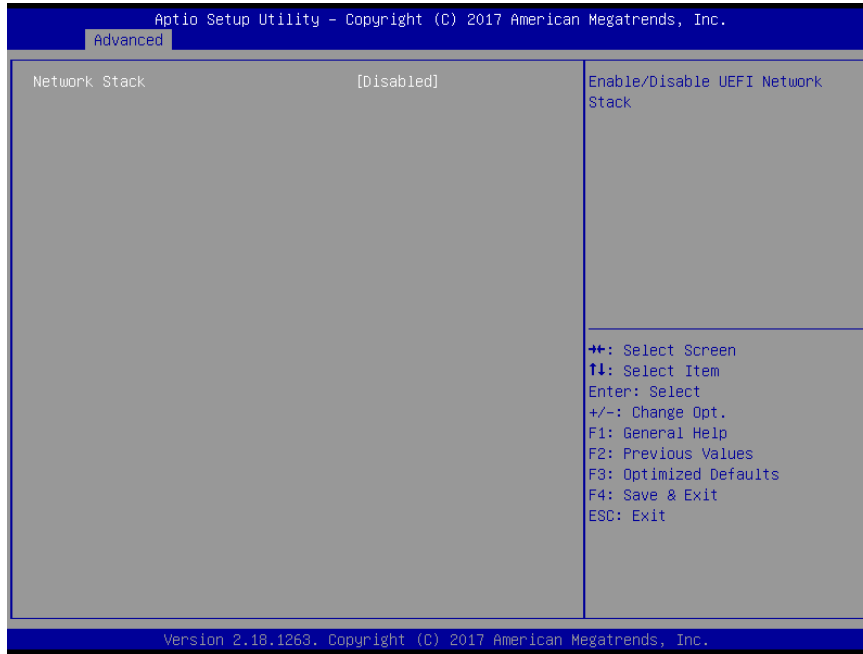

Item	Options	Description
Network Stack	Disabled[Default] Enabled	Enable/Disable UEFI Network Stack.

3.6.2.9 CSM Configuration

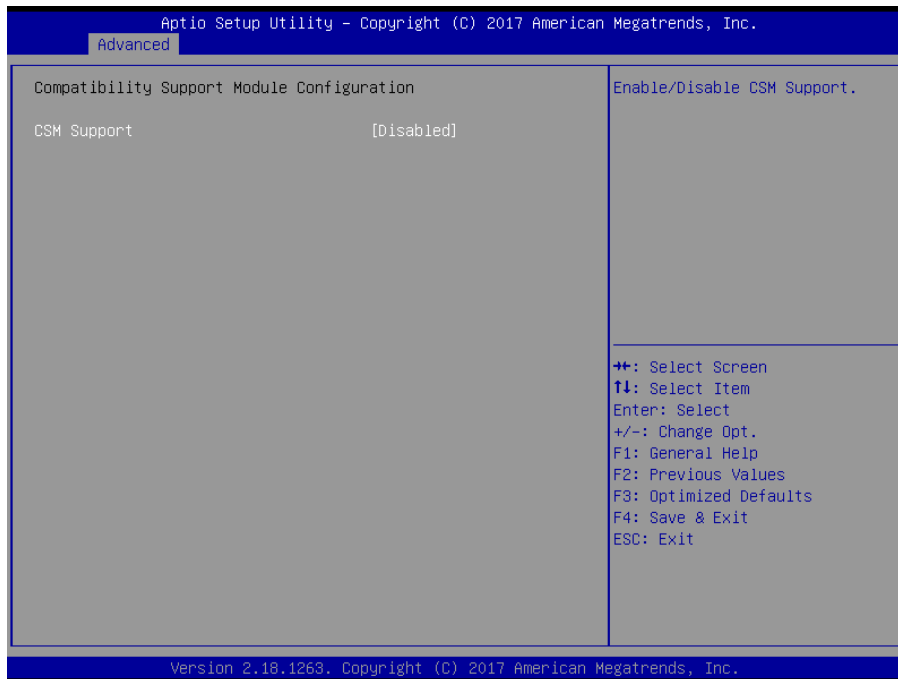

Item	Options	Description
CSM Support	Disabled[Default] Enabled	Enable/Disable CSM Support.

3.6.2.10 NVMe Configuration

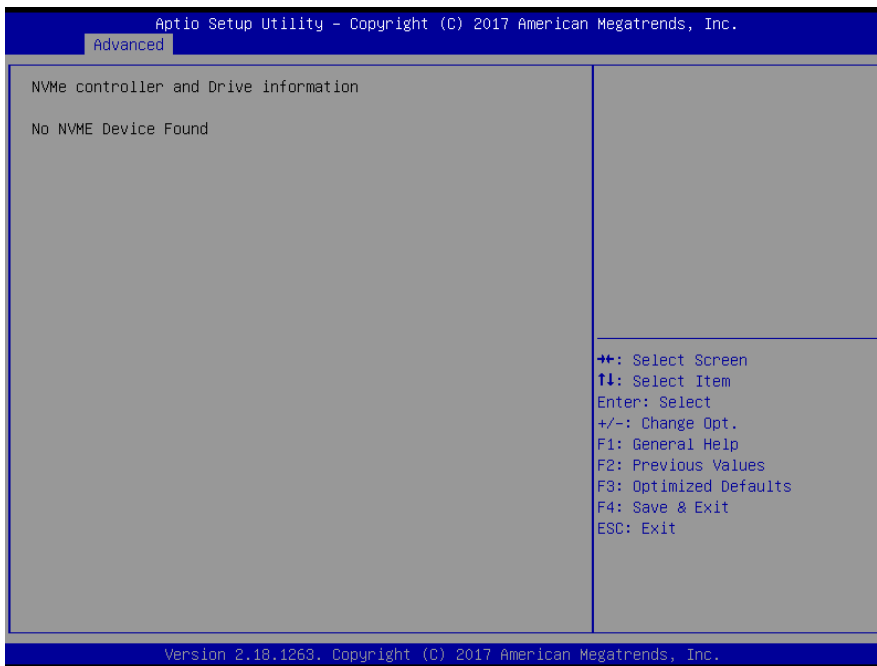

3.6.2.11 USB Configuration

The USB Configuration menu helps read USB information and configures USB settings.

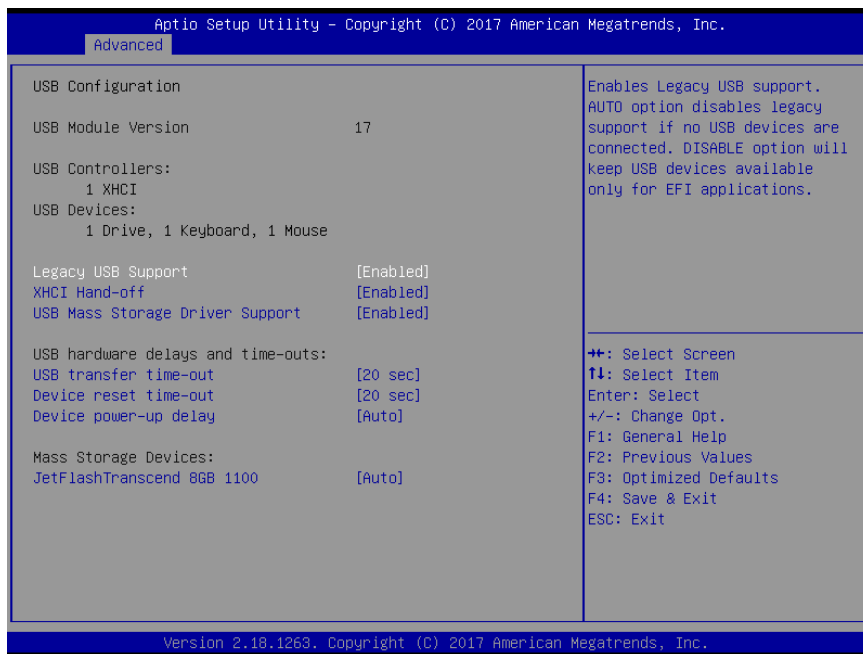

Item	Options	Description
Legacy USB Support	Enabled[Default] Disabled Auto	Enables Legacy USB support. AUTO option disables legacy support if no USB devices are connected. DISABLE option will keep USB devices available only for EFI applications.
XHCI Hand-off	Disabled Enabled[Default]	This is a workaround for OSeS without XHCI hand-off support. The XHCI ownership change should be claimed by XHCI driver.

USB Mass Storage Driver Support	Disabled Enabled[Default]	Enable/Disable USB Mass Storage Driver Support.
USB transfer time-out	1 sec 5 sec 10 sec 20 sec[Default]	The time-out value for Control, Bulk, and Interrupt transfers.
Device reset time-out	10 sec 20 sec[Default] 30 sec 40 sec	USB mass storage device Start Unit command time-out.
Device power-up delay	Auto[Default] Manual	Maximum time the device will take before it properly reports itself to the Host Controller. 'Auto' uses default value: for a Root port it is 100ms, for a Hub port the delay is taken from Hub descriptor.
Mass Storage Devices	Auto[Default] Floppy Forced FDD Hard Disk CD-ROM	Mass storage device emulation type. 'AUTO' enumerates devices according to their media format. Optical drives are emulated as 'CDROM', drives with no media will be emulated according to a drive type.

3.6.2.12 Security Configuration

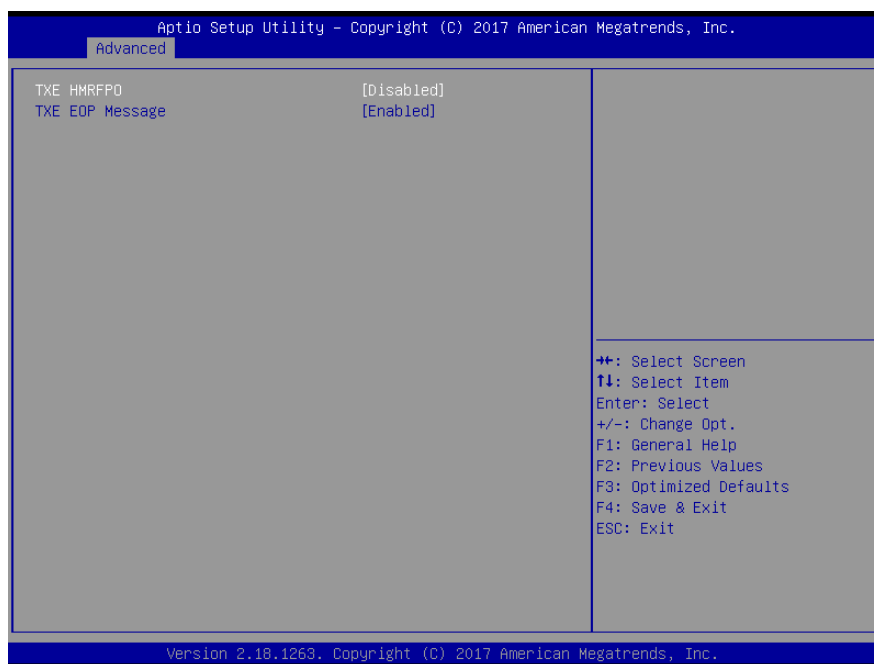

Item	Options	Description
TXE HMRFPD	Enabled Disabled[Default]	TXE HMRFPD.
TXE EOP Message	Enabled[Default] Disabled	Send EOP Message Before Enter OS.

EPX-APLP User's Manual

3.6.3 Chipset



3.6.3.1 North Bridge

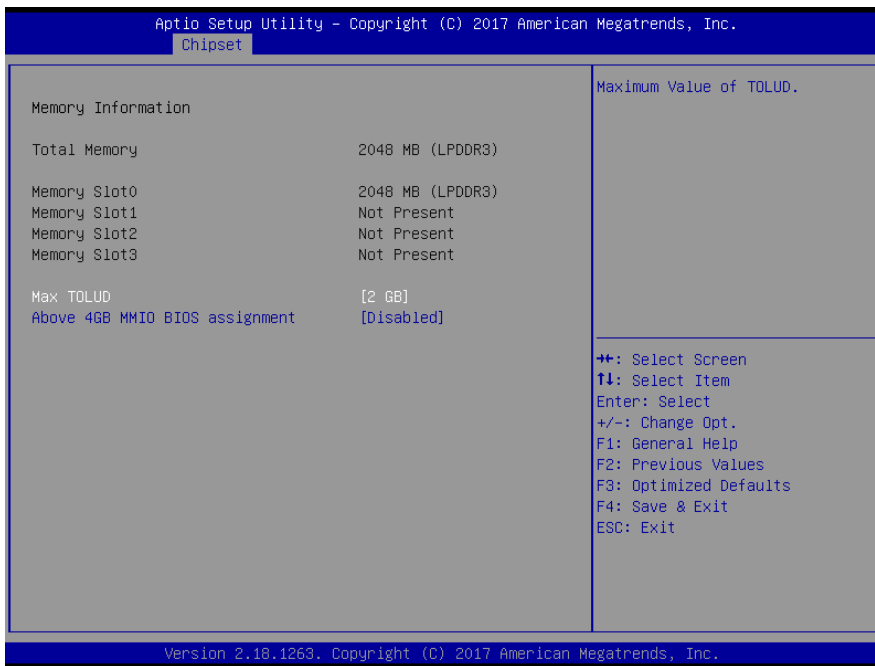

Item	Option	Description
Max TOLUD	2 GB[Default] 2.25 GB 2.5 GB 2.75 GB	Maximum Value of TOLUD.
Above 4GB MMIO BIOS assignment	Enabled, Disabled[Default]	Enable/Disable above 4GB MemoryMappedIO BIOS assignment. This is disabled automatically when Aperture Size is set to 2048MB.

3.6.3.2 South Bridge

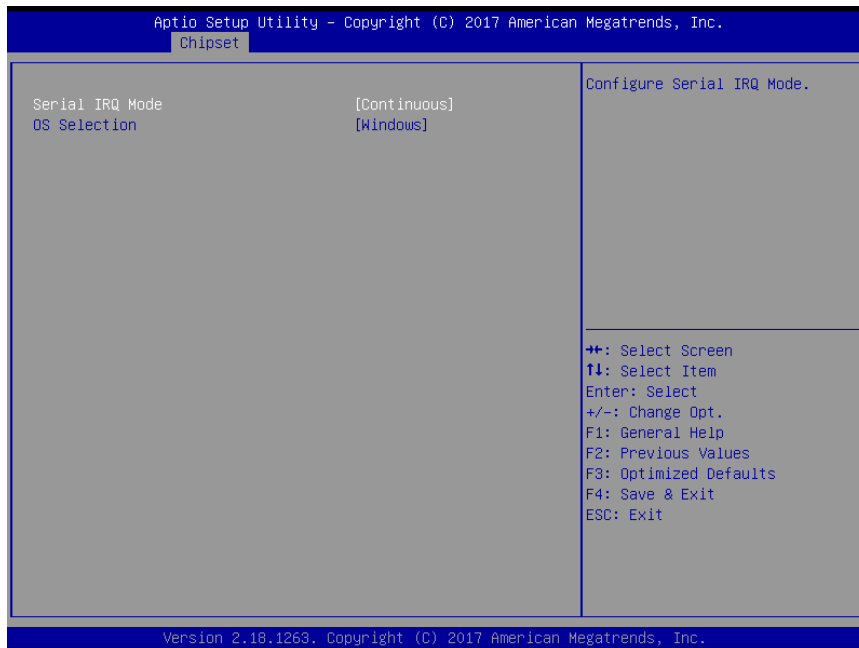

Item	Option	Description
Serial IRQ Mode	Quiet Continuous[Default]	Configure Serial IRQ Mode.
OS Selection	Windows[Default] Android Intel Linux	Select the target OS.

3.6.3.3 Uncore Configuration

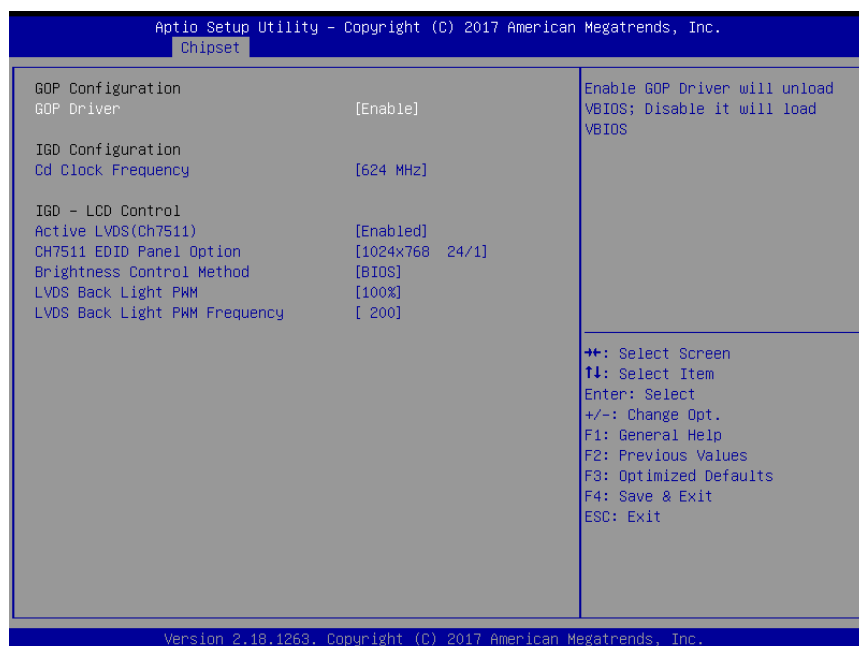

EPX-APLP User's Manual

Item	Option	Description
GOP Driver	Enable[Default] Disable	Enable GOP Driver will unload VBIOS ; Dsiable it will load VBIOS.
Cd Clock Frequency	144 MHz 288 MHz 384 MHz 576 MHz 624 MHz[Default]	Select the highest Cd Clock frequency supported by the platform.
Active LVDS (CH7511)	Disabled Enabled[Default]	Active Internal LVDS(eDP->Ch7511-to-LVDS).
CH7511 EDID Panel Option	1024x768 24/1[Default] 800x600 18/1 1024x768 18/1 1366x768 18/1 1024x600 18/1 1280x800 18/1 1920x1200 24/2 1920x1080 18/2 1280x1024 24/2 1440x900 18/2 1600x1200 24/2 1366x768 24/1 1920x1080 24/2 1680x1050 24/2	Port1-EDP to LVDS(Chrotel 7511) Panel EDID Option.
Brightness Control Method	BIOS[Default] OS Driver	LVDS Brightness Control Method. 1.BIOS 2.Brightness Button 3.Variable Resistor 4.OS Driver.
LVDS Back Light PWM	00% 25% 50% 75% 100%[Default]	Select LVDS back light PWM duty.
LVDS Back Light PWM Frequency	200[Default] 300 400 500 700 1k 2k 3k 5k 10k 20k	Select LVDS back light PWM Frequency.

3.6.3.4 South Cluster Configuration

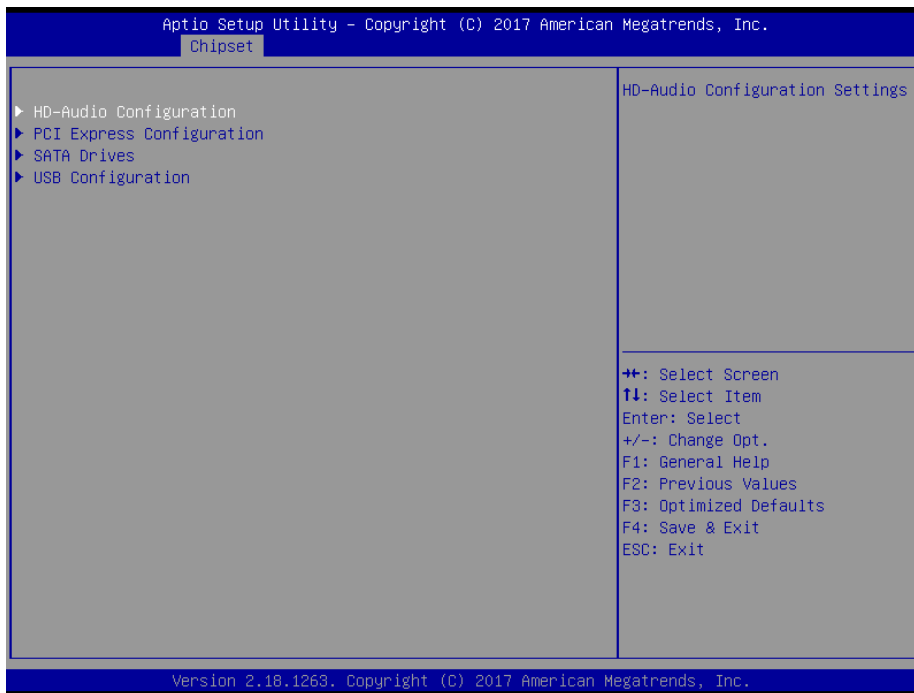

3.6.3.4.1 HD-Audio Configuration



Item	Option	Description
HD-Audio Support	Disable Enable[Default]	Enable/Disable HD-Audio Support.
AMP Gain Setting	11db 14db	Select AMP Gain db.

	19db[Default] 25db	
--	-----------------------	--

3.6.3.4.2 PCI Express Configuration

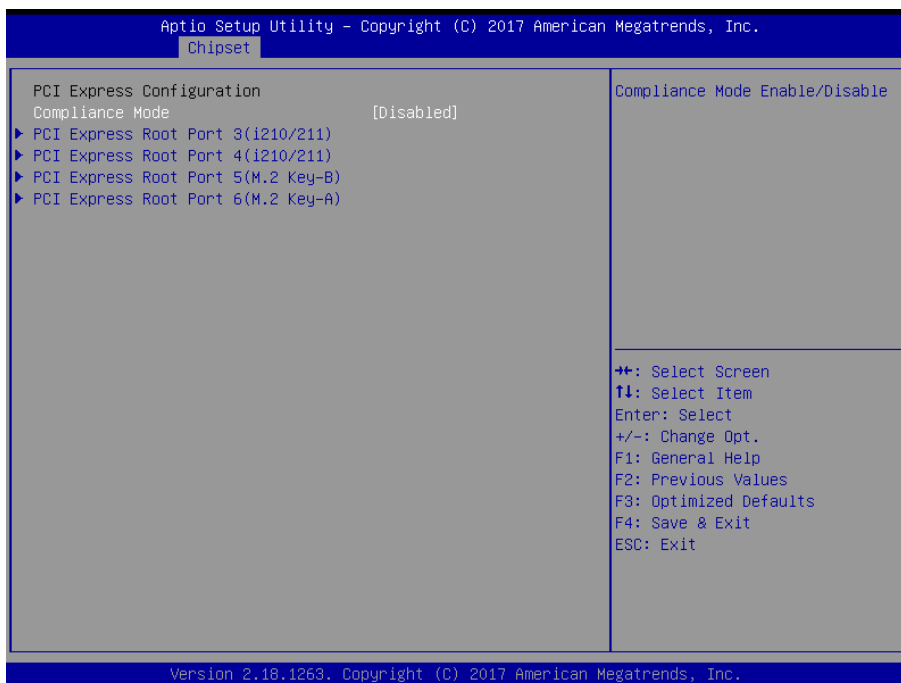

Item	Option	Description
Compliance Mode	Disabled[Default] Enabled	Compliance Mode Enable/Disable.

3.6.3.4.2.1 PCI Express Root Port 3(i210/211)

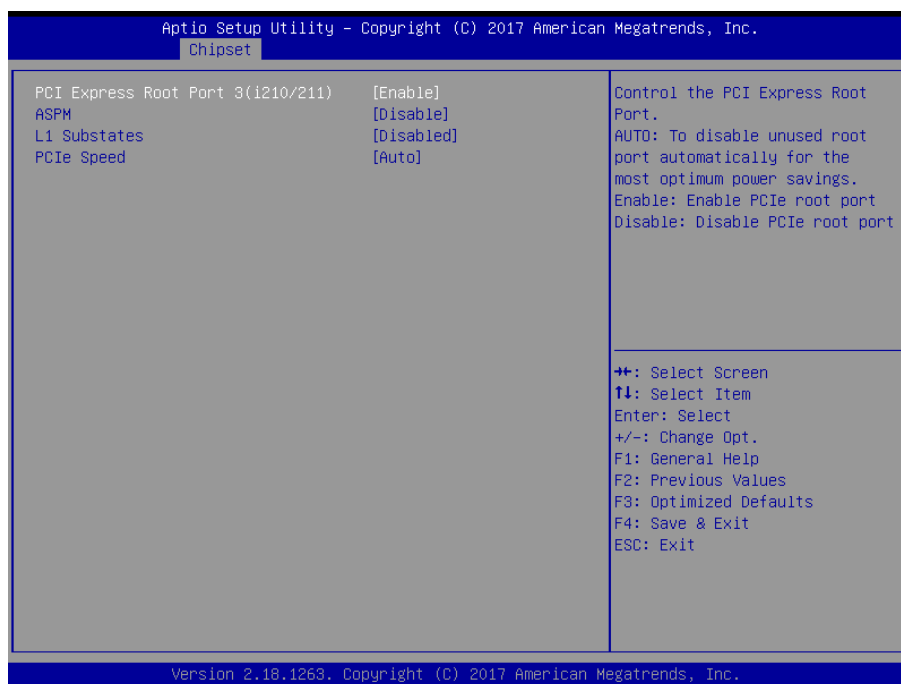

Item	Option	Description
PCI Express Root Port 3(i210/211)	Disable Enable[Default]	Control the PCI Express Root Port. AUTO: To disable unused root port automatically for the most optimum power savings. Enable: Enable PCIe root port Disable: Disable PCIe root port.
ASPM	Disable[Default] L0s L1 L0sL1 Auto	PCI Express Active State Power Management settings.
L1 Substates	Disabled[Default] L1.1 L1.2 L1.1 & L1.2	PCI Express L1 Substates settings.
PCIe Speed	Auto[Default] Gen1 Gen2	Configure PCIe Speed.

3.6.3.4.2.2 PCI Express Root Port 4(i210/211)

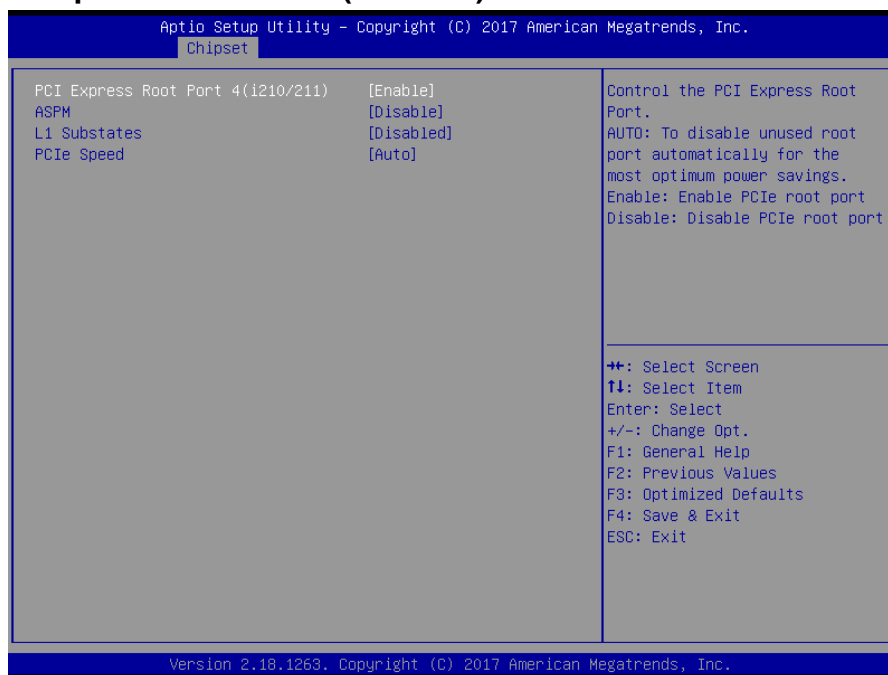

Item	Option	Description
PCI Express Root Port 4(i210/211)	Disable Enable[Default]	Control the PCI Express Root Port. AUTO: To disable unused root port automatically for the most optimum power savings. Enable: Enable PCIe root port Disable: Disable PCIe root port.
ASPM	Disable[Default] L0s L1 L0sL1 Auto	PCI Express Active State Power Management settings.

EPX-APLP User's Manual

L1 Substates	Disabled[Default] L1.1 L1.2 L1.1 & L1.2	PCI Express L1 Substates settings.
PCIe Speed	Auto[Default] Gen1 Gen2	Configure PCIe Speed.

3.6.3.4.2.3 PCI Express Root Port 5(M.2 Key-B)

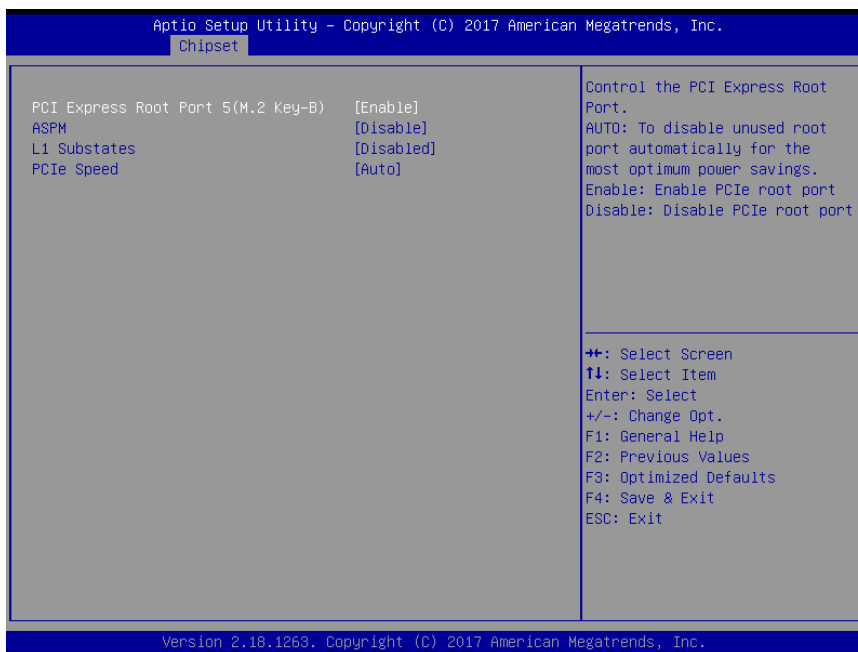

Item	Option	Description
PCI Express Root Port 5(M.2 Key-B)	Disable Enable[Default]	Control the PCI Express Root Port. AUTO: To disable unused root port automatically for the most optimum power savings. Enable: Enable PCIe root port Disable: Disable PCIe root port.
ASPM	Disable[Default] L0s L1 L0sL1 Auto	PCI Express Active State Power Management settings.
L1 Substates	Disabled[Default] L1.1 L1.2 L1.1 & L1.2	PCI Express L1 Substates settings.
PCIe Speed	Auto[Default] Gen1 Gen2	Configure PCIe Speed.

3.6.3.4.2.4 PCI Express Root Port 6(M.2 Key-A)



Item	Option	Description
PCI Express Root Port 6(M.2 Key-A)	Disable Enable[Default]	Control the PCI Express Root Port. AUTO: To disable unused root port automatically for the most optimum power savings. Enable: Enable PCIe root port Disable: Disable PCIe root port.
ASPM	Disable[Default] L0s L1 L0sL1 Auto	PCI Express Active State Power Management settings.
L1 Substates	Disabled[Default] L1.1 L1.2 L1.1 & L1.2	PCI Express L1 Substates settings.
PCIe Speed	Auto[Default] Gen1 Gen2	Configure PCIe Speed.

3.6.3.4.3 SATA Drivers

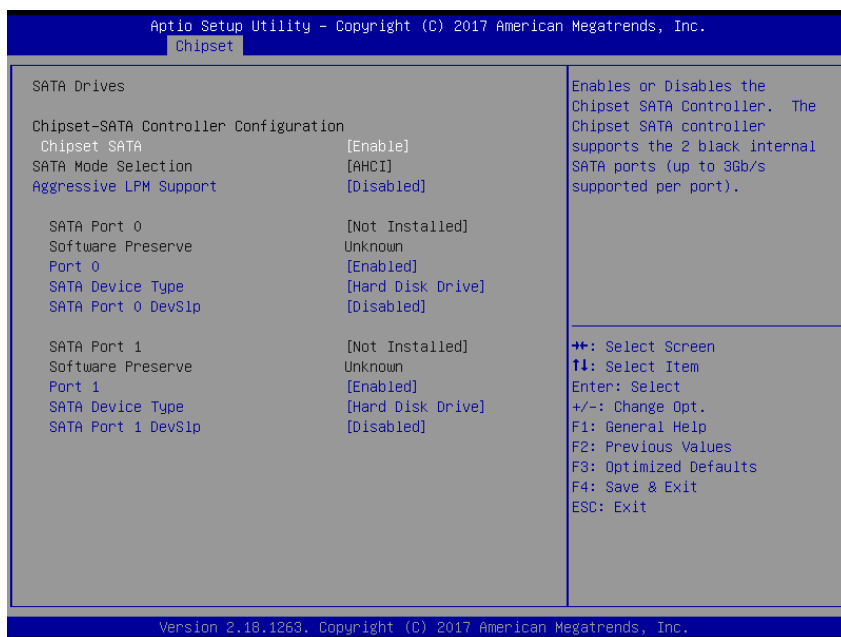

Item	Option	Description
Chipset SATA	Enable[Default] Disable	Enables or Disables the Chipset SATA Controller. The Chipset SATA controller supports the 2 black internal SATA ports (up to 3Gb/s supported per port).
Aggressive LPM Support	Disabled[Default] Enabled	Enable PCH to aggressively enter link power state.
Port 0/1	Disabled Enabled[Default]	Enable or Disable SATA Port.
SATA Device Type	Hard Disk Drive[Default] Solid State Drive	Identify the SATA port is connected to Solid State Drive or Hard Disk Drive.
SATA Port 0/1 DevSlp	Disabled[Default] Enabled	Enable/Disable SATA Port 0/1 DevSlp. Board rework for LP needed before enable.

3.6.3.4.4 USB Configuration

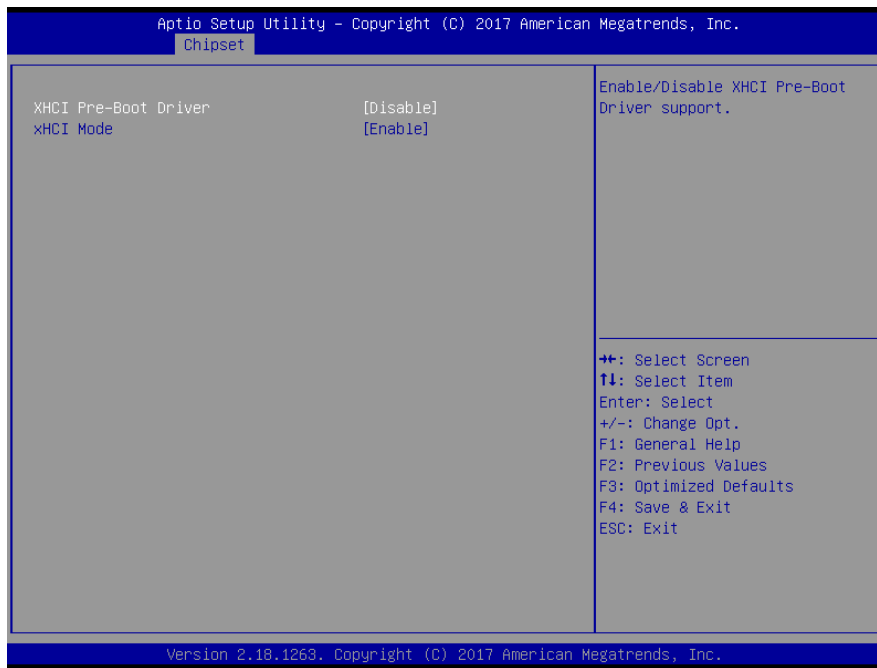

Item	Option	Description
XHCI Pre-Boot Driver	Enable Disable[Default]	Enable/Disable XHCI Pre-Boot Driver support.
xHCI Mode	Enable[Default] Disable	Once disabled, XHCI controller would be function disabled, none of the USB devices are detectable and usable during boot and in OS. Do not disable it unless for debug purpose.

3.6.4 Security

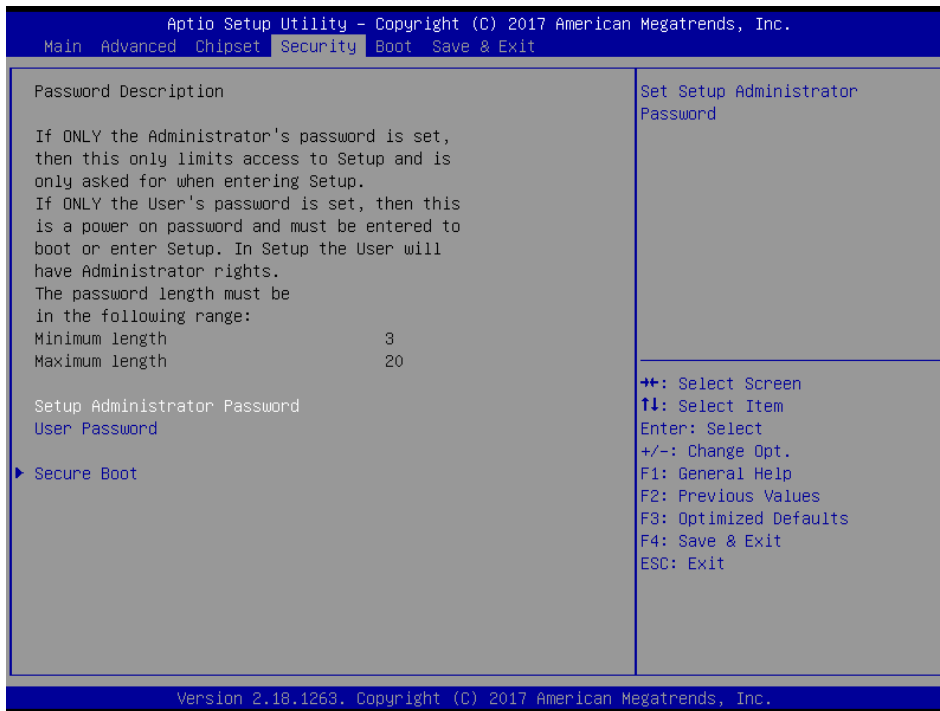

- **Setup Administrator Password**

Set setup Administrator Password

- **User Password**

Set User Password

3.6.4.1 Secure Boot



Item	Option	Description
Attempt Secure Boot	Disabled Enabled[Default]	Secure Boot activated when Platform Key(PK) is enrolled, System mode is User/Deployed, and CSM function is disabled.
Secure Boot Mode	Standard[Default] Customized	Secure Boot Mode – Custom_Standard, Set UEFI Secure Boot Mode to STANDARD mode or CUSTOM mode, this change is effect after save. And after reset, the mode will return to STANDARD mode.

3.6.5 Boot

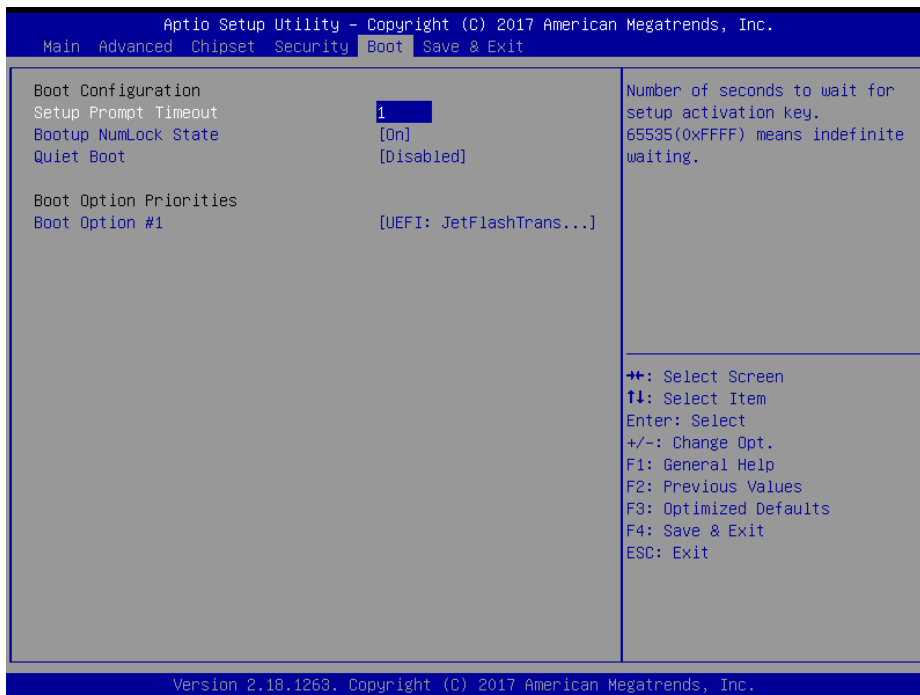

Item	Option	Description
Setup Prompt Timeout	1~ 65535	Number of seconds to wait for setup activation key. 65535(0xFFFF) means indefinite waiting.
Bootup NumLock State	On[Default] Off	Select the Keyboard NumLock state
Quiet Boot	Disabled[Default] Enabled	Enables or disables Quiet Boot option
Boot Option #1	Set the system boot order.	

3.6.6 Save and exit

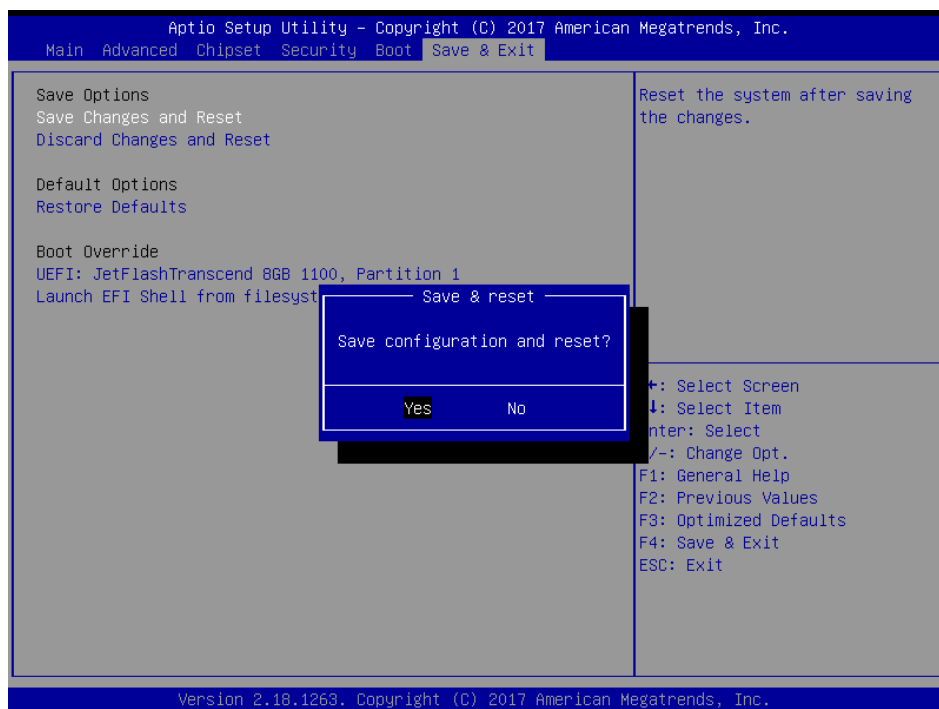
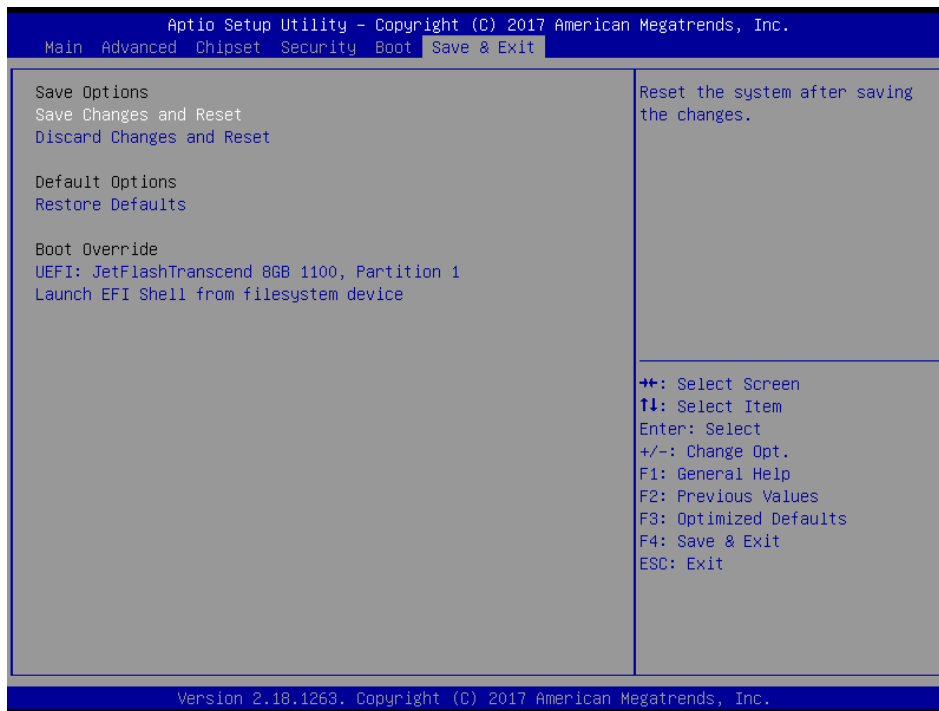

3.6.6.1 Save Changes and Reset

Reset the system after saving the changes.

3.6.6.2 Discard Changes and Reset

Any changes made to BIOS settings during this session of the BIOS setup program are

EPX-APLP User's Manual

discarded. The setup program then exits and reboots the controller.

3.6.6.3 *Restore Defaults*

This option restores all BIOS settings to the factory default. This option is useful if the controller exhibits unpredictable behavior due to an incorrect or inappropriate BIOS setting.

3.6.6.4 *Launch EFI Shell from filesystem device*

Attempts to Launch EFI Shell application (Shellx64.efi) from one of the available filesystem devices.

4. Drivers Installation



Note: Installation procedures and screen shots in this section are for your reference and may not be exactly the same as shown on your screen.

4.1 Install Chipset Driver

Insert the Supporting DVD-ROM to DVD-ROM drive, and it should show the index page of our products automatically. If not, locate Index.htm and choose the product from the menu left.



Note: The installation procedures and screen shots in this section are based on Windows 10 operation system. If the warning message appears while the installation process, click Continue to go on.

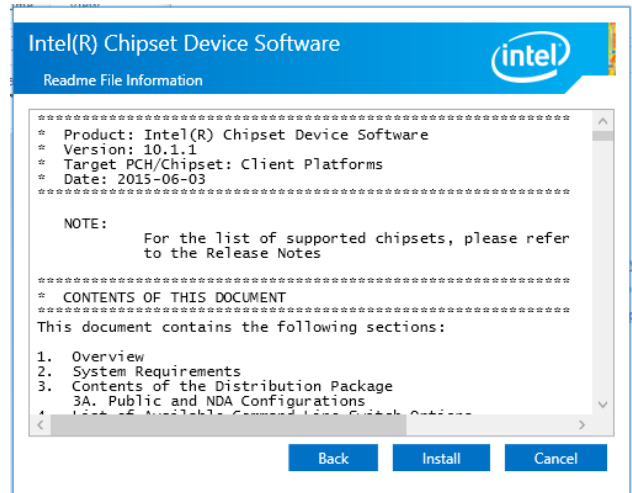

Step 3. Click Install.

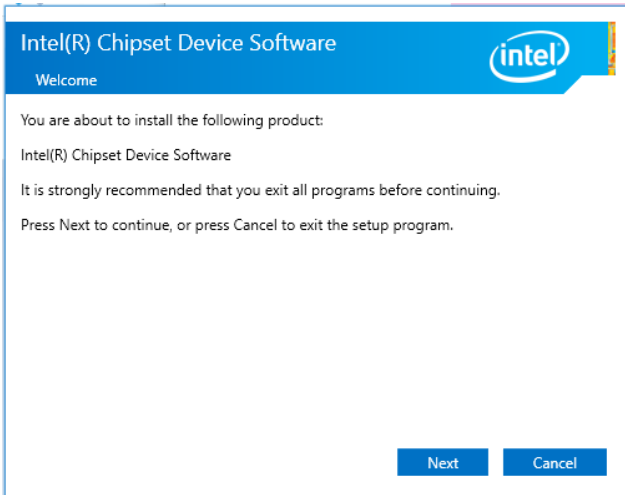

Step1. Click Next.

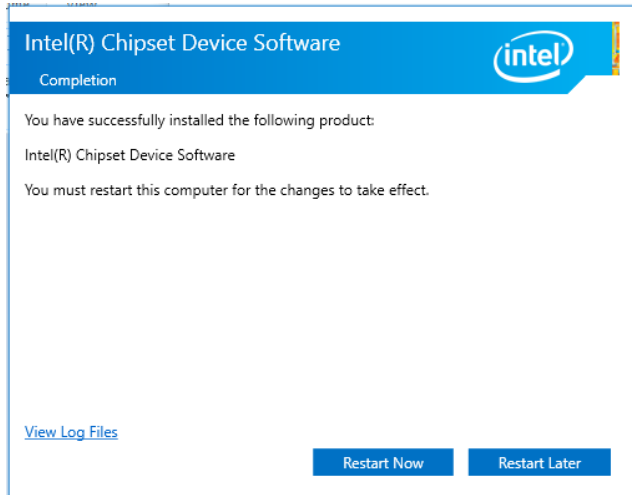

Step 4. Complete setup.

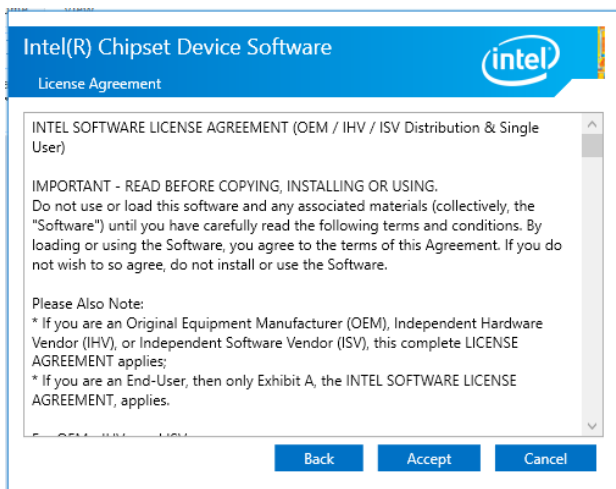

Step 2. Click Accept.

4.2 Install TXE Driver

Insert the Supporting DVD-ROM to DVD-ROM drive, and it should show the index page of our products automatically. If not, locate Index.htm and choose the product from the menu left.



Note: The installation procedures and screen shots in this section are based on Windows 10 operation system. If the warning message appears while the installation process, click Continue to go on.

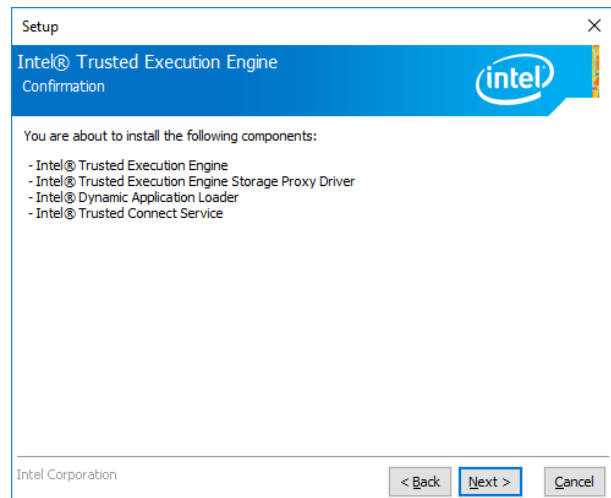

Step 3. Click **Next** to continue installation.

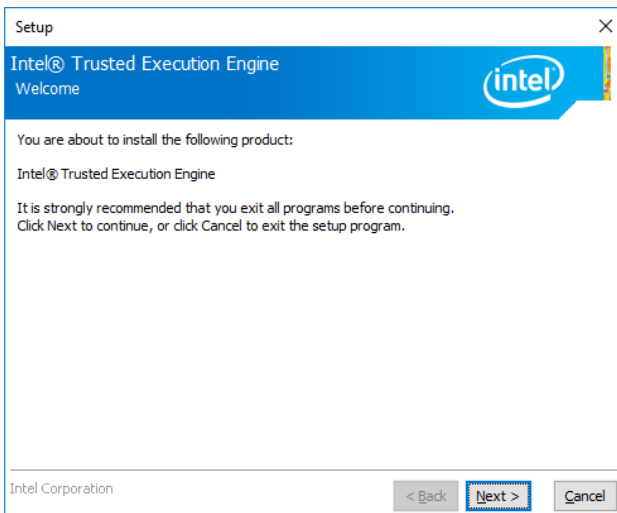

Step1. Click **Next** to start installation.

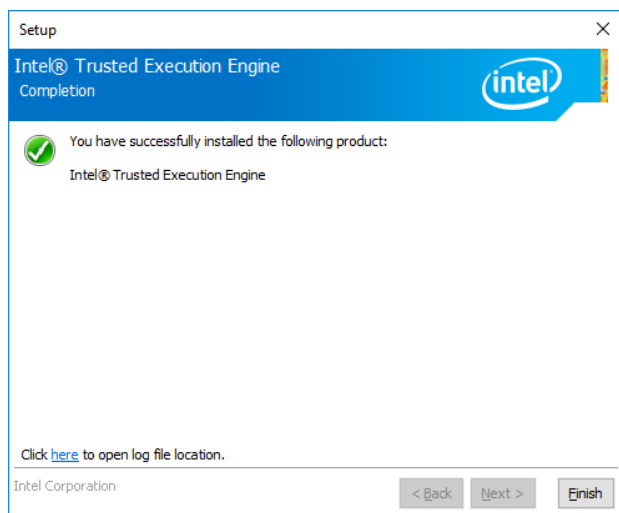

Step 4. Click **Finish** to complete setup.

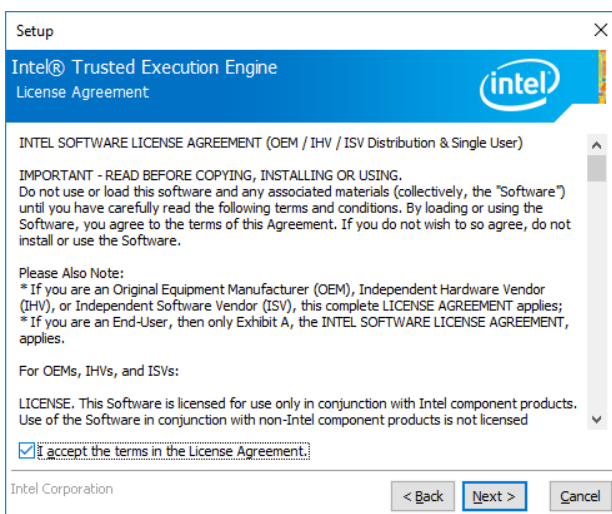

Step 2. Click **Next**.

4.3 Install VGA Driver

Insert the Supporting DVD-ROM to DVD-ROM drive, and it should show the index page of our products automatically. If not, locate Index.htm and choose the product from the menu left.



Note: The installation procedures and screen shots in this section are based on Windows 10 operation system.

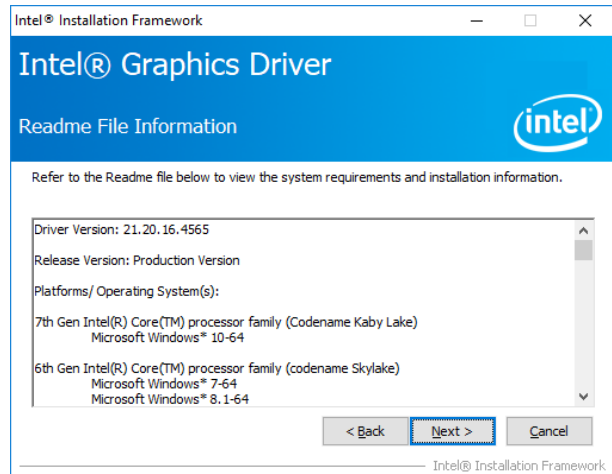

Step 3. Click Next.

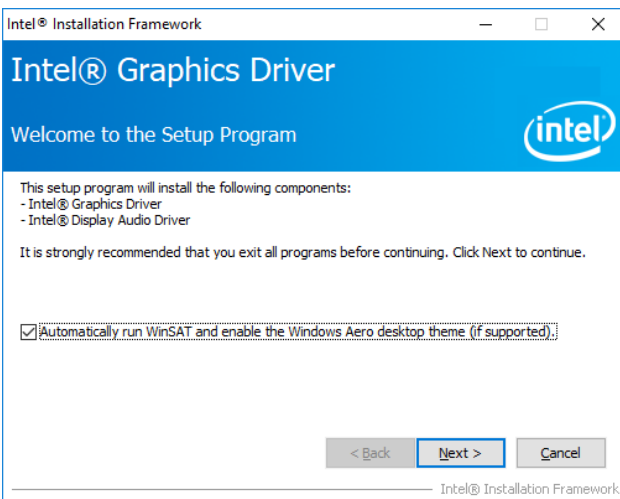

Step 1. Click Next.

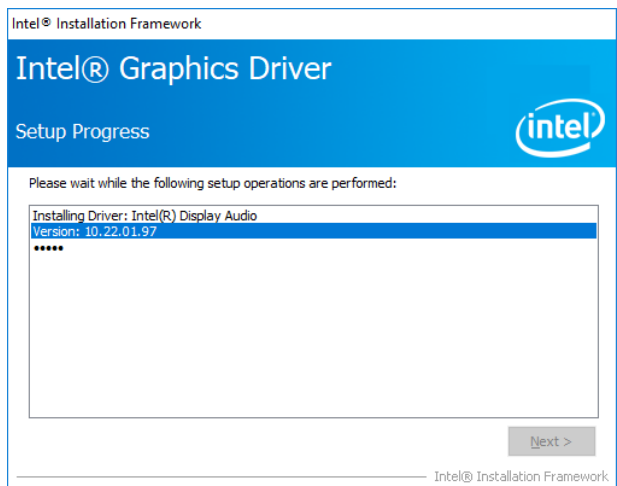

Step 4. Click Next.

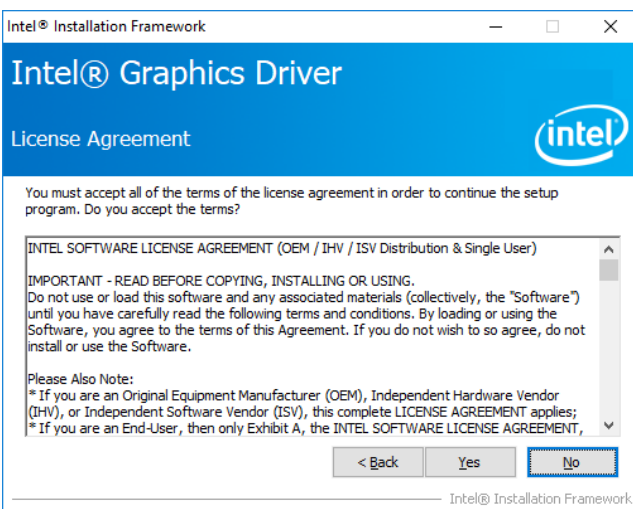

Step 2.

Click **Yes** to accept license agreement.

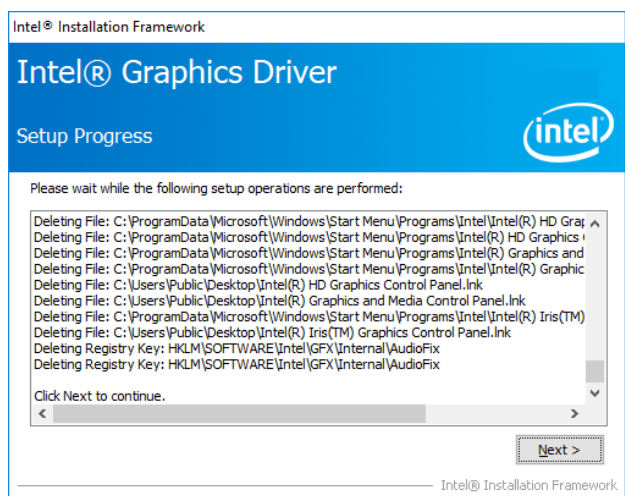

Step 5. Click Next.

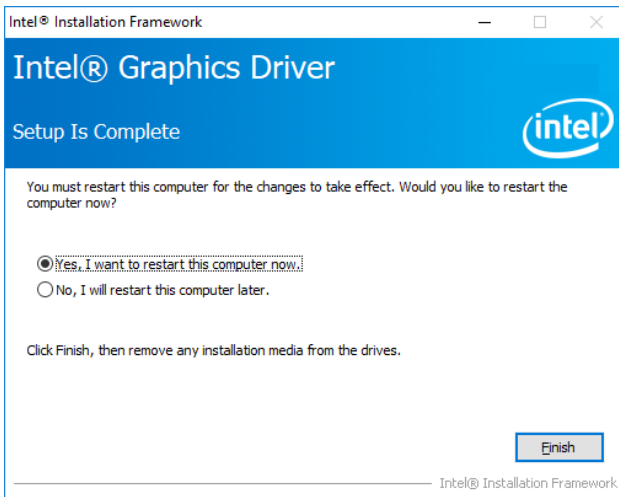

Step 6. Click **Finish** to complete setup.

4.4 Install Audio Driver

Insert the Supporting CD-ROM to CD-ROM drive, and it should show the index page of our products automatically. If not, locate Index.htm and choose the product from the menu left.



Note: The installation procedures and screen shots in this section are based on Windows 10 operation system.

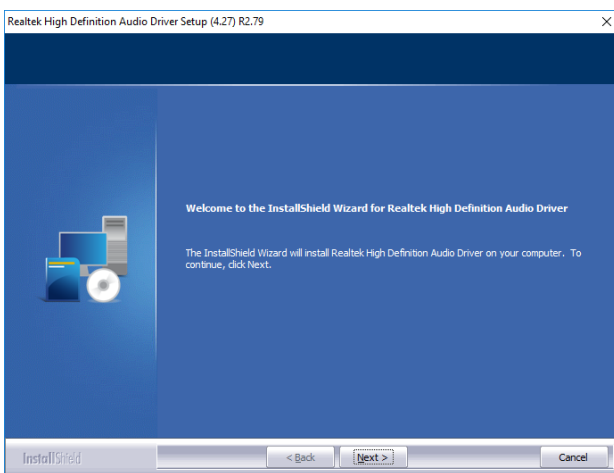

Step 1. Click **Next** to continue setup.

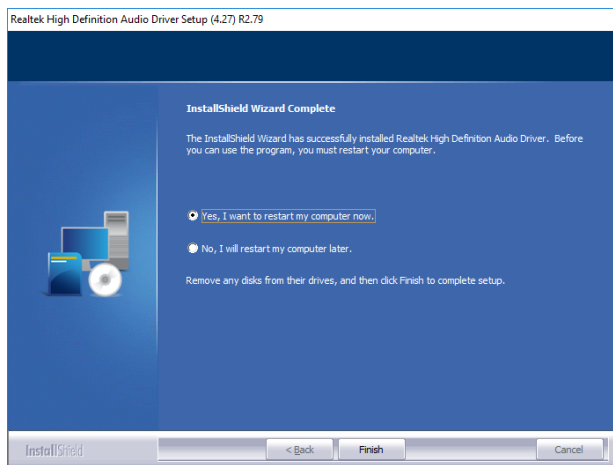

Step 2. Click **Finish** to complete the setup.

4.5 Install Ethernet Driver

Insert the Supporting DVD-ROM to DVD-ROM drive, and it should show the index page of our products automatically. If not, locate Index.htm and choose the product from the menu left, or link to **/Driver_Gigabit/Intel/I211AT/ECM-APL_LAN**.



Note: The installation procedures and screen shots in this section are based on Windows 10 operation system.

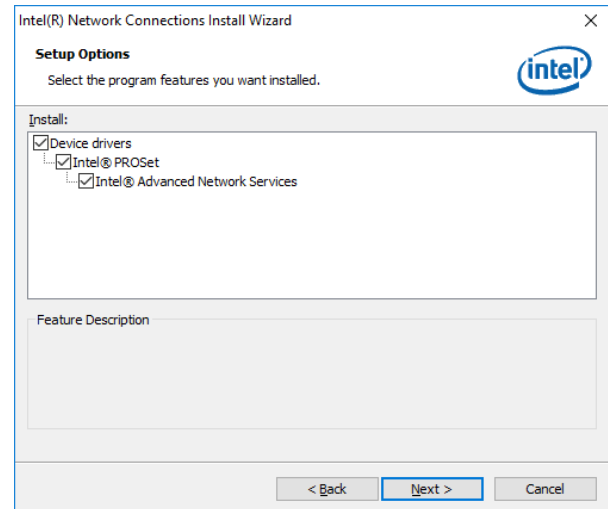

Step 3. Click Next.

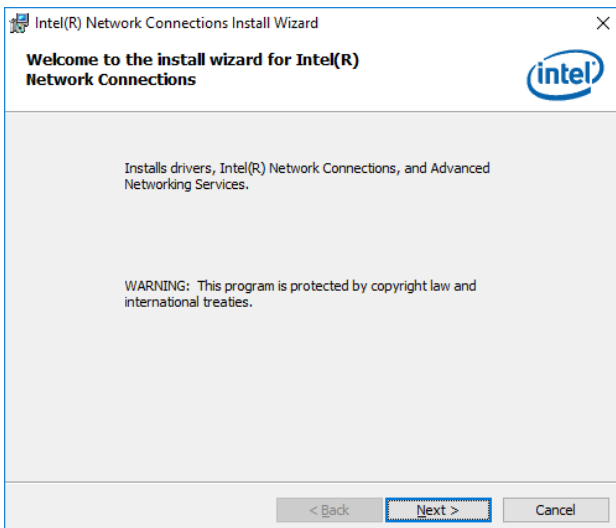

Step 1. Click Next

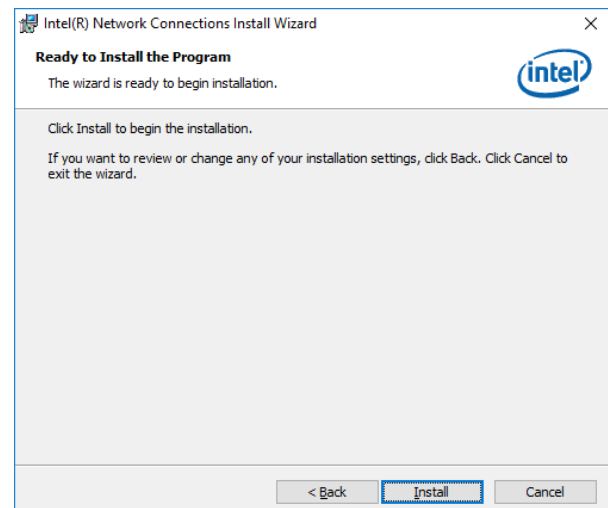

Step 4. Click Install.

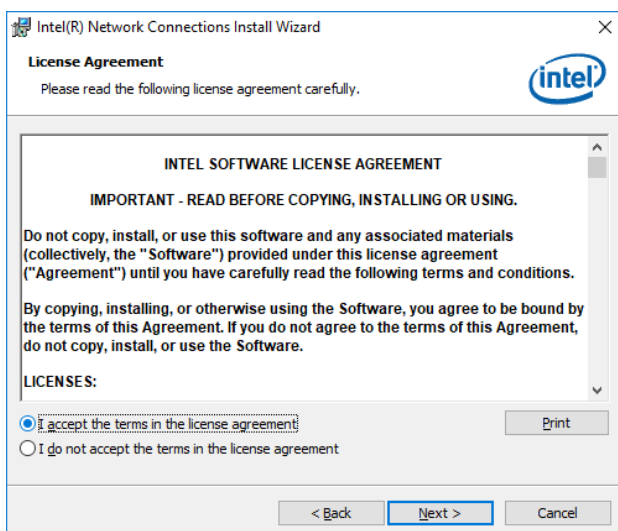

Step 2. Click Next to proceed.

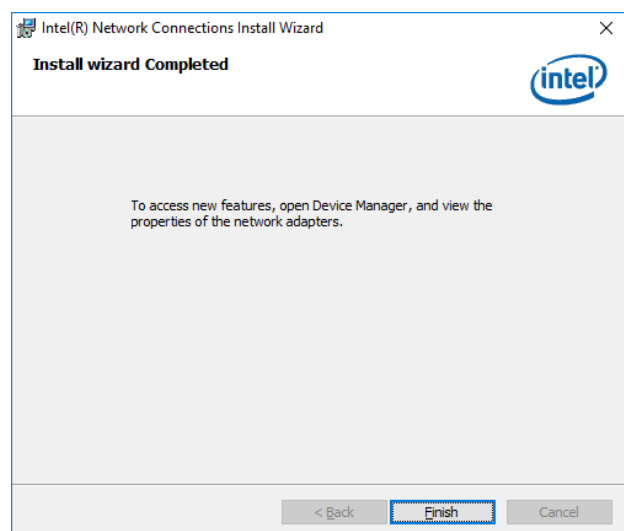

Step 5. Click Finish to complete the setup.

4.6 Install Serial IO Driver

Insert the Supporting CD-ROM to CD-ROM drive, and it should show the index page of our products automatically. If not, locate Index.htm and choose the product from the menu left.



Note: The installation procedures and screen shots in this section are based on Windows 10 operation system.

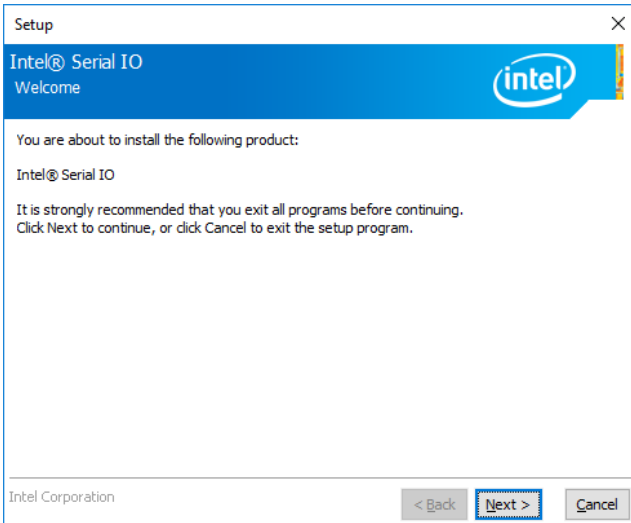

Step 1. Click Next to continue setup.

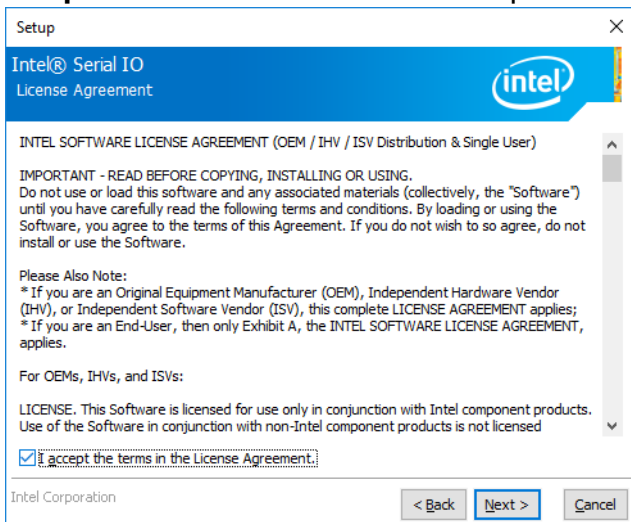

Step 2. Click Next.

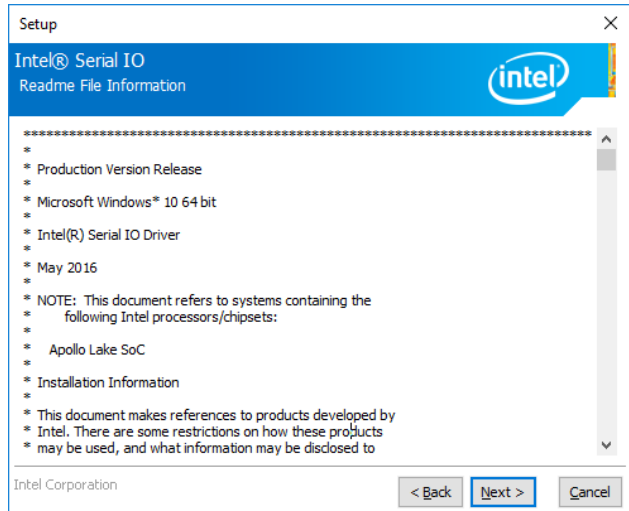

Step 3. Click Next.

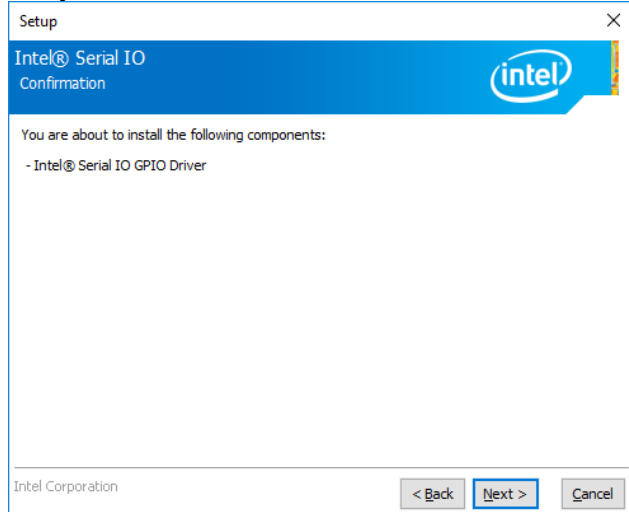

Step 4. Click Next.

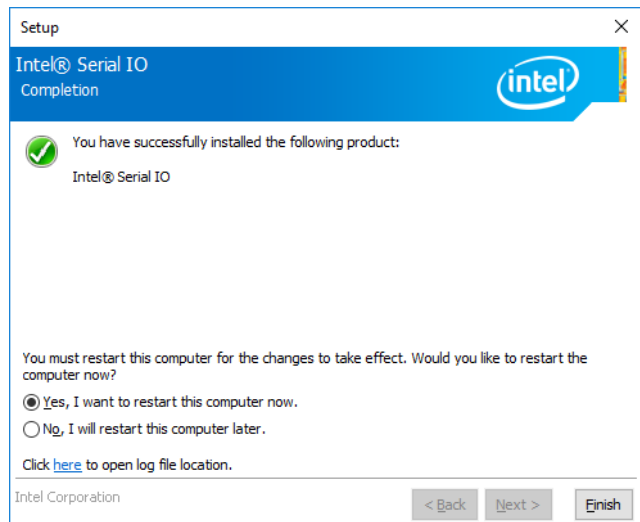

Step 5. Click Finish to complete the setup.

5. Mechanical Drawing



EPX-APLP User's Manual

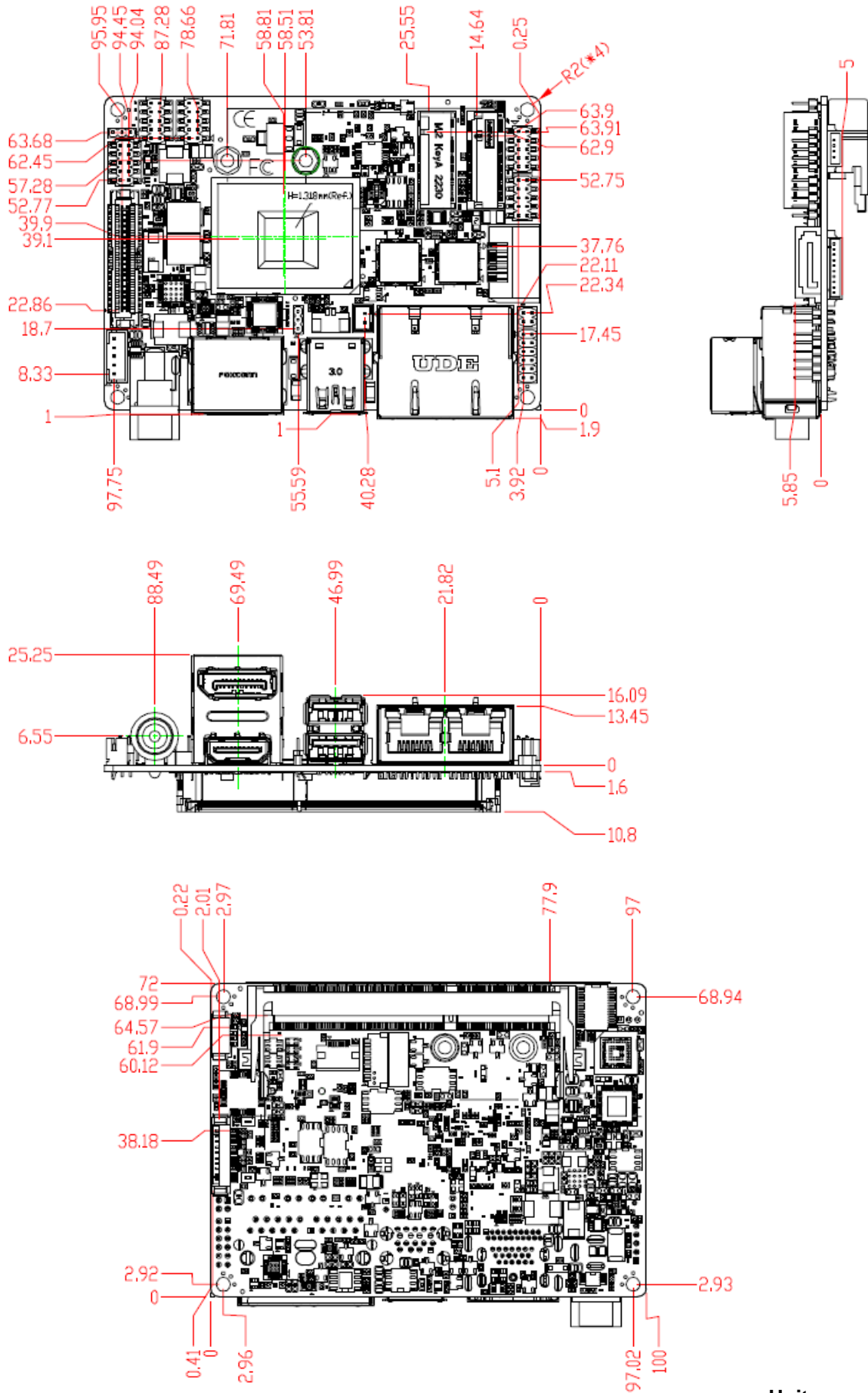

Unit: mm

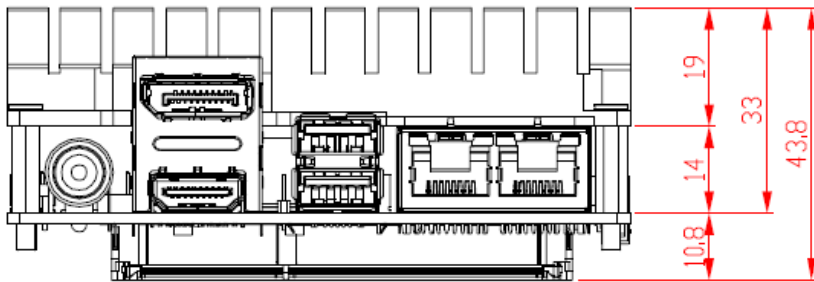
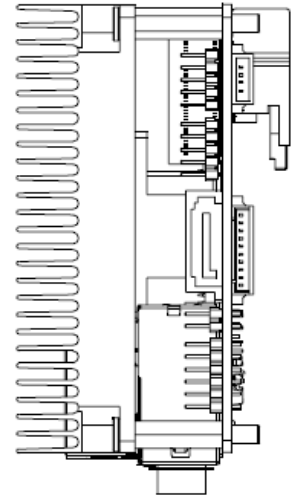
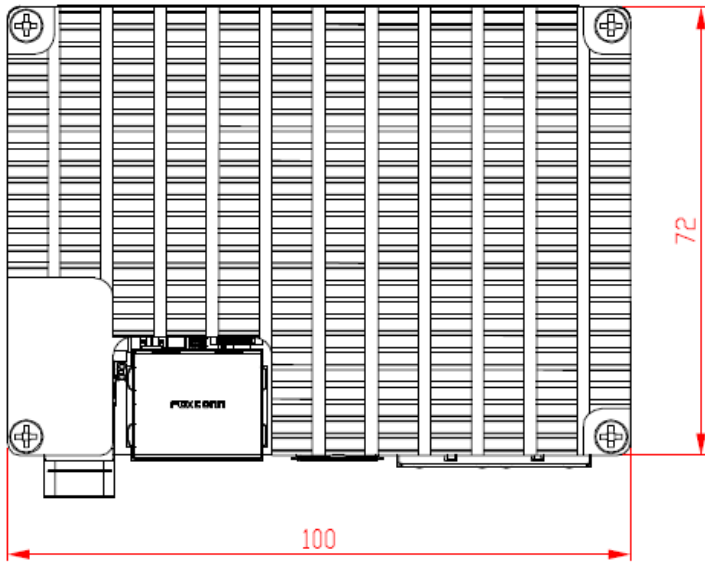

Unit: mm

