

APC-2132

21.5" 6th Gen Intel® Core™ i7/i5/i3/Celeron Expantable Ultra
light Multi-Touch Fanless Panel PC

Quick Reference Guide

2nd Ed – 31 October 2017

Copyright Notice

Copyright © 2017 ALL RIGHTS RESERVED.

FCC Statement



THIS DEVICE COMPLIES WITH PART 15 FCC RULES. OPERATION IS SUBJECT TO THE FOLLOWING TWO CONDITIONS:

(1) THIS DEVICE MAY NOT CAUSE HARMFUL INTERFERENCE.

(2) THIS DEVICE MUST ACCEPT ANY INTERFERENCE RECEIVED INCLUDING INTERFERENCE THAT MAY CAUSE UNDESIRE OPERATION.

THIS EQUIPMENT HAS BEEN TESTED AND FOUND TO COMPLY WITH THE LIMITS FOR A CLASS "A" DIGITAL DEVICE, PURSUANT TO PART 15 OF THE FCC RULES.

THESE LIMITS ARE DESIGNED TO PROVIDE REASONABLE PROTECTION AGAINST HARMFUL INTERFERENCE WHEN THE EQUIPMENT IS OPERATED IN A COMMERCIAL ENVIRONMENT. THIS EQUIPMENT GENERATES, USES, AND CAN RADIATE RADIO FREQUENCY ENERGY AND, IF NOT INSTALLED AND USED IN ACCORDANCE WITH THE INSTRUCTION MANUAL, MAY CAUSE HARMFUL INTERFERENCE TO RADIO COMMUNICATIONS.

OPERATION OF THIS EQUIPMENT IN A RESIDENTIAL AREA IS LIKELY TO CAUSE HARMFUL INTERFERENCE IN WHICH CASE THE USER WILL BE REQUIRED TO CORRECT THE INTERFERENCE AT HIS OWN EXPENSE.

A Message to the Customer

Customer Services

Each and every product is built to the most exacting specifications to ensure reliable performance in the harsh and demanding conditions typical of industrial environments. Whether your new device is destined for the laboratory or the factory floor, you can be assured that your product will provide the reliability and ease of operation.

Your satisfaction is our primary concern. Here is a guide to our customer services. To ensure you get the full benefit of our services, please follow the instructions below carefully.

Technical Support

We want you to get the maximum performance from your products. So if you run into technical difficulties, we are here to help. For the most frequently asked questions, you can easily find answers in your product documentation. These answers are normally a lot more detailed than the ones we can give over the phone. So please consult the user's manual first.

Content

| | | |
|-----------|--|-----------|
| 1. | Getting Started | 5 |
| 1.1 | Safety Precautions | 5 |
| 1.2 | Packing List..... | 5 |
| 1.3 | System Specifications | 6 |
| 1.4 | System Overview | 9 |
| 1.4.1 | Front View..... | 9 |
| 1.4.2 | Rear View | 10 |
| 1.5 | System Dimensions | 11 |
| 2. | Hardware Configuration | 12 |
| 2.1 | APC-2132 connector mapping | 13 |
| 2.1.1 | Serial port 1 connector (COM1)..... | 13 |
| 2.1.2 | Serial port 2 connector (COM2)..... | 13 |
| 2.2 | Storage Installation | 14 |
| 2.3 | ARC-SKLU Overviews | 15 |
| 2.4 | ARC-SKLU Jumper and Connector list | 16 |
| 2.5 | ARC-SKLU Jumpers & Connectors settings | 18 |
| 2.5.1 | Clear CMOS (JCOMS1) | 18 |
| 2.5.2 | Serial port 1/2 pin9 signal select (JRI1/JRI2) | 18 |
| 2.5.3 | LCD backlight brightness adjustment (JBKLSEL1) | 19 |
| 2.5.4 | AT/ATX auto power on select (JAT1)..... | 19 |
| 2.5.5 | Serial port 1 in RS-232/422/485 mode (JCOM1_SEL1)..... | 20 |
| 2.5.6 | LCD Inverter connector (JBKL1) | 20 |
| 2.5.7 | On-board header for USB2.0 (JUSB1)..... | 21 |
| 2.5.8 | On-board header for USB2.0 (JUSB2)..... | 21 |
| 2.5.9 | On-board header for USB2.0 (JUSB3)..... | 22 |
| 2.5.10 | Battery connector (JBAT1) | 22 |
| 2.5.11 | LVDS connector (JLVDS1)..... | 23 |
| 2.5.12 | Speaker_R (JSPR1) | 24 |
| 2.5.13 | Speaker_L (JSPL1) | 24 |
| 2.5.14 | SPI connector (JSPI1) | 25 |
| 2.5.15 | EC Debug connector (JEC1) | 25 |
| 2.5.16 | LCD backlight brightness adjustment (JBLK_CTRL1) | 26 |
| 2.5.17 | UPS-GPIO connector (JUUPS1)..... | 26 |
| 2.5.18 | B2B connector (JB2B1) | 27 |

APC-2132

| | | |
|---------|---|----|
| 2.5.19 | SATA Power connector (SATAPW1)..... | 28 |
| 2.5.20 | General purpose I/O connector (JGPIO1)..... | 28 |
| 2.5.21 | Miscellaneous setting connector (JFP2) | 29 |
| 2.5.22 | LED connector (JLED1)..... | 29 |
| 2.5.23 | Serial port 1 connector (COM1)..... | 30 |
| 2.6 | ARC-SKLU DB-B Overviews..... | 31 |
| 2.7 | ARC-SKLU DB-B Jumper and Connector list..... | 32 |
| 2.8 | ARC-SKLU DB-B Jumpers & Connectors settings..... | 33 |
| 2.8.1 | Serial port 1 in RS-232/422/485 mode (JCOMSEL1)..... | 33 |
| 2.8.2 | Audio connector (JMIC1)..... | 33 |
| 2.8.2.1 | Signal Description – Audio connector (JMIC1)..... | 33 |
| 2.8.3 | Serial port 1 connector (JCOM1)..... | 34 |
| 2.8.4 | RS-422/RS-485 Termination Resistance connector (JCOMS1) | 34 |
| 2.8.5 | B2B connector (B2B1)..... | 35 |
| 2.8.6 | USB connector 2 (JUSB2)..... | 36 |

1. Getting Started

1.1 Safety Precautions

Warning!



Always completely disconnect the power cord from your chassis whenever you work with the hardware. Do not make connections while the power is on. Sensitive electronic components can be damaged by sudden power surges. Only experienced electronics personnel should open the PC chassis.

Caution!



Always ground yourself to remove any static charge before touching the CPU card. Modern electronic devices are very sensitive to static electric charges. As a safety precaution, use a grounding wrist strap at all times. Place all electronic components in a static-dissipative surface or static-shielded bag when they are not in the chassis.

1.2 Packing List

- 1 x APC-2132 21.5" 6th Gen Intel® Core™ i7/i5/i3/Celeron Expantable Ultra light Multi-Touch Fanless Panel PC
- 1 x 19V/3.78A 72W power adapter
- 1 x power cord



If any of the above items is damaged or missing, contact your retailer.

1.3 System Specifications

| Component | |
|--------------------------|---|
| Mother Board | SBC Share with ARC-SKLU (P/N: E9697ASKL05R i7-6600U/ 09R i5-6300U/ 10R i3-6100U, 11R Celeron 3955U) |
| CPU | Intel Core i/ Celeron BGA CPU (15W) 6th Gen Intel® Core™ i7-6600U, 2-Core, 2.6GHz processor 6th Gen Intel® Core™ i5-6300U, 2-Core, 2.4GHz processor 6th Gen Intel® Core™ i3-6100U, 2-Core, 2.3GHz processor 6th Gen Intel® Celeron® 3955U, 2-Core Processor |
| CPU Cooler (Type) | Heatsink |
| Memory | One 260-pin SODIMM Socket Up to 16GB DDR4 2133 SDRAM |
| Power Supply | DC in |
| Adapter | AC/DC adapter 19V/3.78A BCC-ADP-072N-01R |
| Speaker | 0.5W *2 |
| Camera | By optional |
| Wireless LAN | By optional (mini PCIe module) |
| Bluetooth | By optional (mini PCIe module) |
| Operating System | Support Win 7/8/10, Linux |
| Expansion Card | 1* full size mini PCIe slot 1* half size mini PCIe slot (by IET module) |
| Storage | |
| Hard Disk Drive | By SATA port |
| Solid State Drive | By SATA port |
| Panel | |
| LCD Panel | 21.5" AUO T215HVN01 (E96892X5022R):15.2W Or AUO G215HVN01.0 (E9689421500R): 23W |
| LCD Control Board | LED driving board: E968X000104R (only for T215HVN01) |
| Touch Screen | 21.5" PCAP multi touch |
| Touch Controller | EETI EXC3188 (come with touch) |
| Others | Front power button & program buttons (daughter board: E9697173ME1R) |
| External I/O | |
| Serial Port | 2 x DB-9 COM (COM1 RS-232/422/485, selectable by Jumper, RS-485) |

| | |
|-----------------------------|--|
| | supports Auto Flow, Pin-9 selected by Ring/+5V/+12V, COM2 RS-232 only) |
| USB Port | 4 x USB3.0 (2 x Double deck) 2 x USB2.0 (by IET module) |
| Video Port | HDMI (by IET module) |
| Audio Port | 1 x Line out (by IET module) 1 x Mic in (by IET module) |
| LAN Port | 1 x I219LM PHY, 1 x Intel I211AT GbE controller |
| Wireless LAN Antenna | Optional Internal antenna*2 |
| Indicator Light | HDD LED, Power LED |
| Others | NA |
| Mechanical | |
| Power Type | DC in +12V ~ 26V |
| Power Connector Type | Lockable DC jack |
| Dimension | 539.6 x 342.6 x 45.5mm |
| Weight | 6.2kg |
| Color | Black plastic |
| Fanless | Yes |
| OS Support | Windows 7/8/10, Linux |
| Reliability | |
| EMI Test | CE/ FCC class B |
| Dust and Rain Test | Front Panel IP65 |
| Vibration Test | <p>Random Vibration Operation</p> <p>Reference IEC60068-2-64 Testing procedures</p> <p>Test Fh : Vibration broadband random Test</p> <p>1 Test PSD : 0.00454G²/Hz , 1.5 Grms</p> <p>2 Test frequency : 5~500 Hz</p> <p>3 Test axis : X,Y and Z axis</p> <p>4 Test time : 30 minutes each axis</p> <p>5 System condition : operation mode</p> <p>6 Test curve</p> <p>Sine Vibration Test</p> <p>Reference IEC60068-2-6 Testing procedures</p> <p>Test Fc : Vibration sinusoidal</p> <p>1 Test Acceleration : 2G</p> <p>2 Test frequency : 5~500 Hz</p> <p>3 Sweep : 1 Oct/ per one minute. (logarithmic)</p> <p>4 Test axis : X,Y and Z axis</p> <p>5 Test time :10 min. each axis</p> |

| | |
|------------------------------|---|
| | <p>6 System condition : Non-Operating mode</p> <p>7 Test curve</p> <p>Package Vibration Test:</p> <p>Reference IEC60068-2-64 Testing procedures</p> <p>Test Fh : Vibration boardband random Test</p> <p>1 Test PSD : 0.026G²/Hz , 2.16 Grms</p> <p>2 Test frequency : 5~500 Hz</p> <p>3 Test axis : X,Y and Z axis</p> <p>4 Test time : 30 minutes each axis</p> <p>5 Test curve</p> |
| Mechanical Shock Test | With CF/SSD: 10Grms, IEC 60068-2-27, Half Sine, 11ms |
| Drop Test | <p>Package drop test</p> <p>Reference ISTA 2A, Method : IEC-60068-2-32 Test:Ed</p> <p>Test Ea : Drop Test</p> <p>1 Test phase : One corner, three edges, six faces</p> <p>2 Test high :</p> <p>3 Package weight :</p> <p>4 Test drawing</p> |
| Operating Temperature | 0 ~ 40 degree |
| Operating Humidity | 0 ~ 90% Relative Humidity, Non-condensing |
| Storage Temperature | -20 ~ 60 degree |



Note: Specifications are subject to change without notice.

1.4 System Overview

1.4.1 Front View

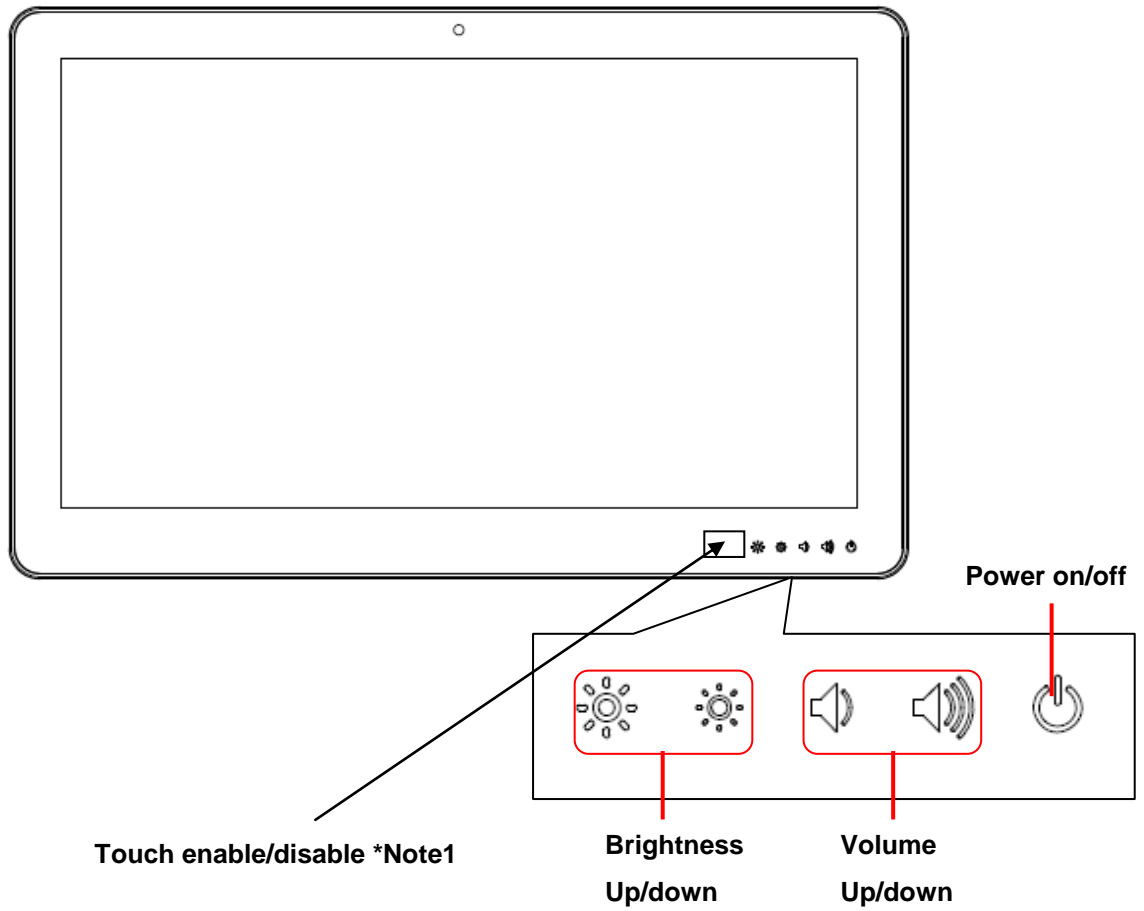

Note1:

Continue press 4 sec to disable and enable touch function.

1.4.2 Rear View

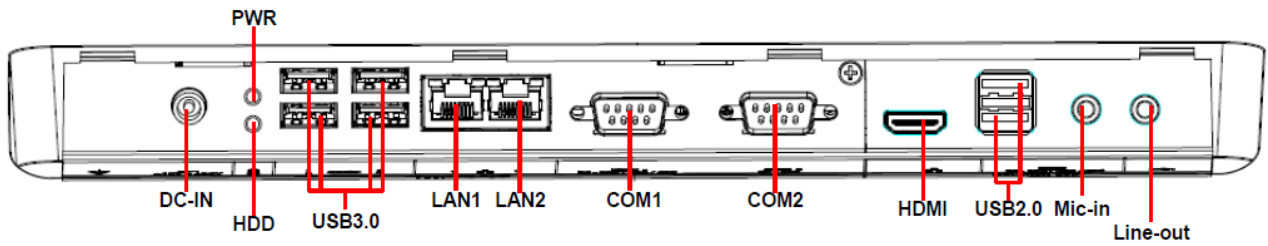

Connectors

| Label | Function | Note |
|----------|--|---------------------|
| COM1/2 | Serial port 1/2 connector | DB-9 male connector |
| DC in | DC-in power connector | |
| HDD | HDD LED | |
| PWR | Power LED | |
| LAN1/2 | RJ-45 Ethernet 1/2 | |
| Mic-in | Mic-in audio jack | |
| Line-out | Line-out audio jack | |
| Reset | Rest button | |
| USB | 2 x USB 2.0 connector 4 x USB 3.0 connector | |
| HDMI | HDMI connector | |

1.5 System Dimensions

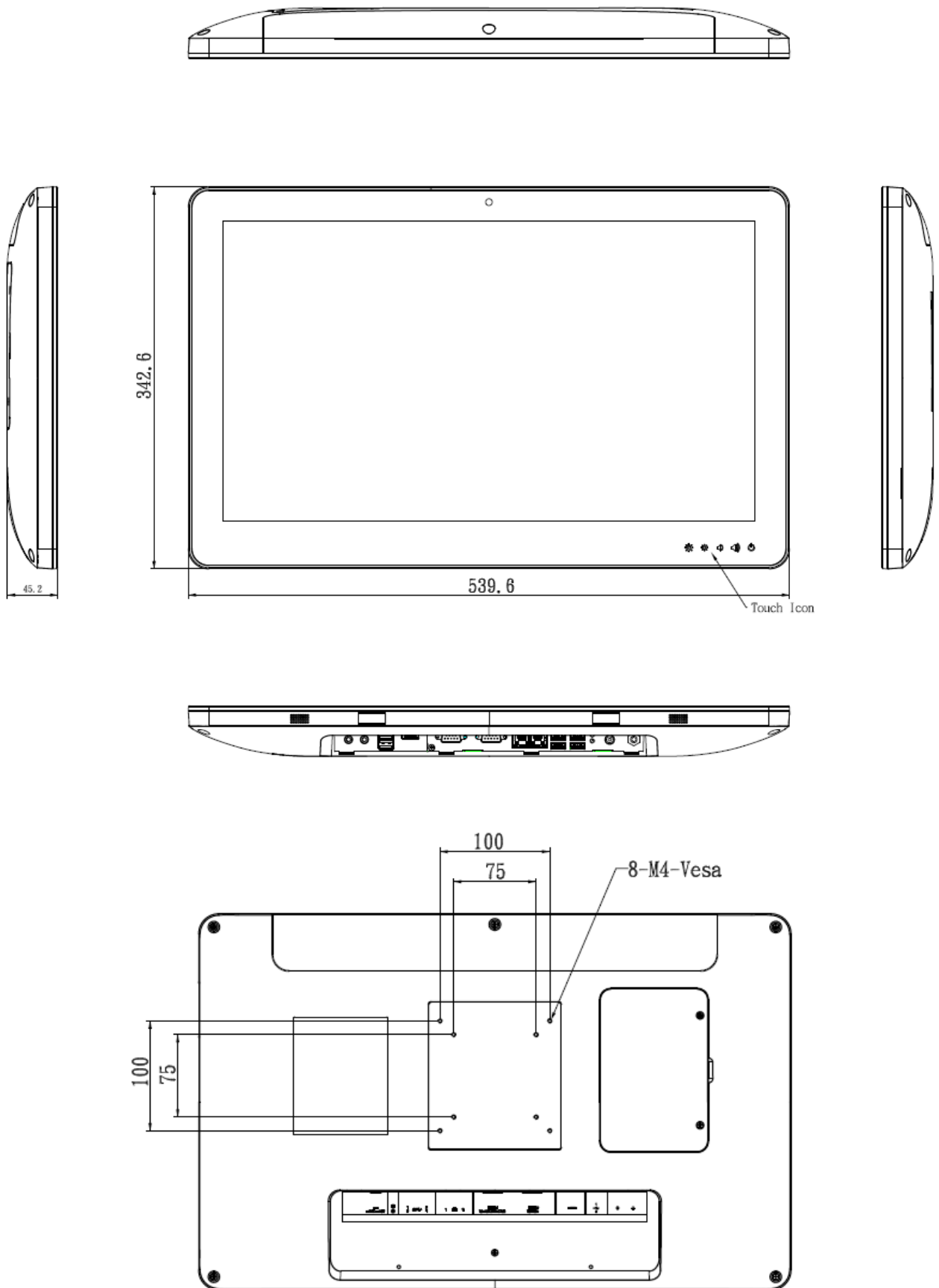

(Unit: mm)

2. Hardware Configuration

For advanced information, please refer to:

- 1- ARC-SKLU and ARC-SKLU DB-B included in this manual.

2.1 APC-2132 connector mapping

2.1.1 Serial port 1 connector (COM1)

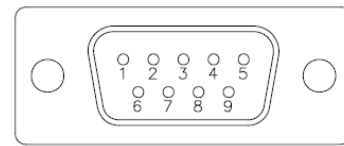
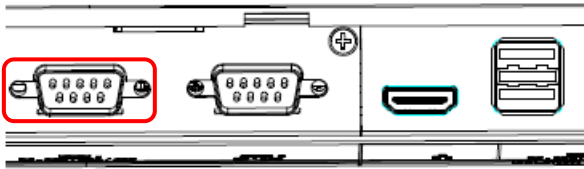

RS-485

| Signal | PIN | PIN | Signal |
|--------|-----|-----|--------|
| DATA- | 1 | 6 | NC |
| DATA+ | 2 | 7 | NC |
| NC | 3 | 8 | NC |
| NC | 4 | 9 | NC |
| GND | 5 | | |

RS-232

| Signal | PIN | PIN | Signal |
|--------|-----|-----|--------|
| DCD | 1 | 6 | DSR |
| RXD | 2 | 7 | RTS |
| TXD | 3 | 8 | CTS |
| DTR | 4 | 9 | RI |
| GND | 5 | | |

RS-422

| Signal | PIN | PIN | Signal |
|--------|-----|-----|--------|
| TxD- | 1 | 6 | NC |
| TxD+ | 2 | 7 | NC |
| RxD+ | 3 | 8 | NC |
| RxD- | 4 | 9 | NC |
| GND | 5 | | |

2.1.2 Serial port 2 connector (COM2)

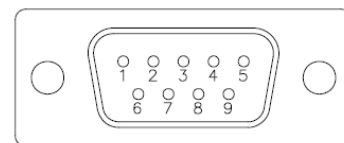
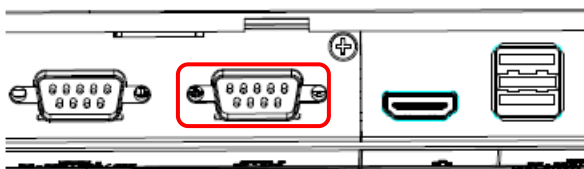

RS-232

| Signal | PIN | PIN | Signal |
|--------|-----|-----|--------|
| DCD | 1 | 6 | DSR |
| RXD | 2 | 7 | RTS |
| TXD | 3 | 8 | CTS |
| DTR | 4 | 9 | RI |
| GND | 5 | | |

2.2 Storage Installation

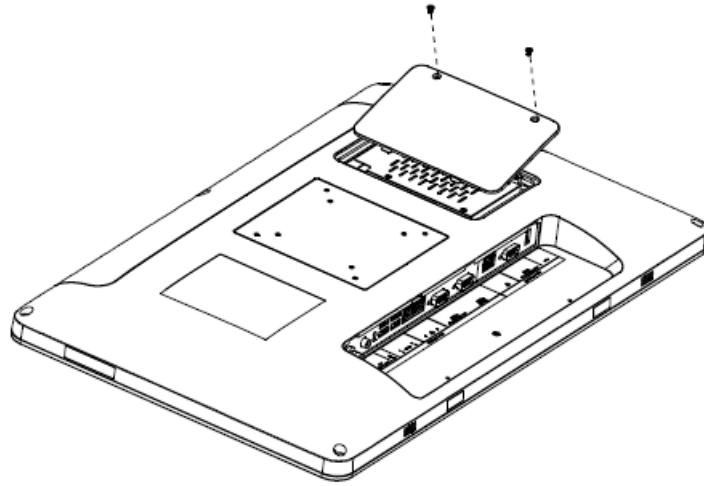

Step 1. Remove 2 screws to release the chassis cover, and remove it.

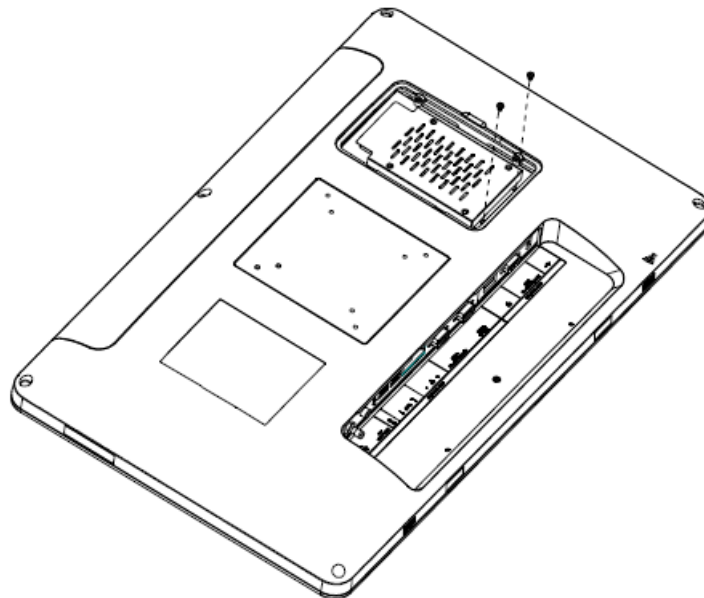

Step 2. Insert the HDD back and fasten 2 screws.

2.3 ARC-SKLU Overviews

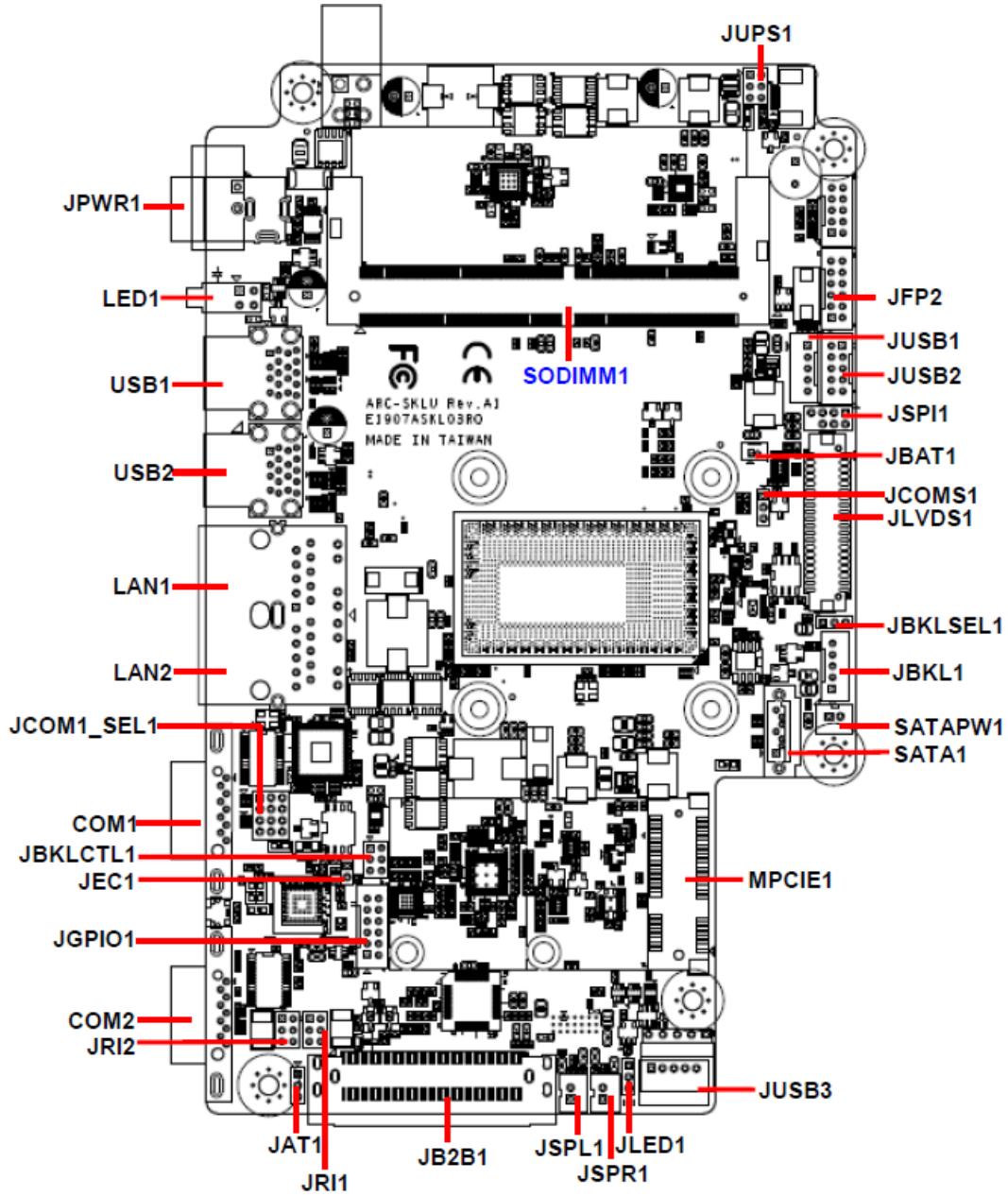

2.4 ARC-SKLU Jumper and Connector list

Jumpers

| Label | Function | Note |
|------------|--------------------------------------|----------------------------|
| JCOMS1 | Clear CMOS | 3 x 1 header, pitch 2.00mm |
| JRI1/2 | Serial port 1/2 pin9 signal select | 3 x 2 header, pitch 2.00mm |
| JCOM1_SEL1 | Serial port 1 in RS-232/422/485 mode | 4 x 3 header, pitch 2.00mm |
| JBKLSEL1 | LCD backlight brightness adjustment | 3 x 1 header, pitch 2.00mm |
| JAT1 | AT/ATX auto power on select | 3 x 1 header, pitch 2.00mm |

Connectors

| Label | Function | Note |
|----------|-------------------------------------|--------------------------------|
| SODIMM1 | 1 x 260-Pin DDR4 2133MHz SO-DIMM | |
| JBKL1 | LCD Inverter connector | 5 x 1 wafer, pitch 2.00mm |
| COM1/2 | Serial port 1/2 connector | D-sub 9 pin, male |
| JSPR1 | Speaker_R | 2 x 1 wafer, pitch 2.00mm |
| JSPL1 | Speaker_L | 2 x 1 wafer, pitch 2.00mm |
| JB2B1 | B2B connector | 40 x 2 wafer, pitch 0.80mm |
| JBKLCTL1 | LCD backlight brightness adjustment | 3 x 2 header, pitch 2.00mm |
| LED1 | HDD/Power LED indicator | |
| JLED1 | LED connector | 3 x 1 header, pitch 2.00mm |
| JFP2 | Miscellaneous setting connector | 5 x 2 wafer, pitch 2.00 mm |
| JLVDS1 | LVDS connector | DIN 40-pin wafer, pitch 1.25mm |
| USB1/2 | USB connector 1/2 | |
| JUSB1 | On-board header for USB2.0 | 5 x 1 wafer, pitch 2.00mm |
| JUSB2 | On-board header for USB2.0 | 5 x 2 wafer, pitch 2.00mm |
| JUSB3 | On-board header for USB2.0 | 5 x 1 wafer, pitch 2.00mm |
| LAN1/2 | RJ-45 Ethernet 1/2 | |
| MPCIE1 | Mini-PCle connector | |
| JBAT1 | Battery connector | 2 x 1 wafer, pitch 1.25mm |
| JGPIO1 | General purpose I/O connector | 6 x 2 wafer, pitch 2.00mm |
| JUPS1 | UPS-GPIO connector | 3 x 2 header, pitch 2.00mm |
| JPWR1 | Power connector | |
| JSPI1 | SPI connector | 4 x 2 header, pitch 2.00mm |
| JEC1 | EC Debug connector | 2 x 1 header, pitch 2.00 mm |

| | | |
|----------------|----------------------|---------------------------|
| SATA1 | Serial ATA connector | |
| SATAPW1 | SATA Power connector | 2 x 1 wafer, pitch 2.00mm |

2.5 ARC-SKLU Jumpers & Connectors settings

2.5.1 Clear CMOS (JCOMS1)

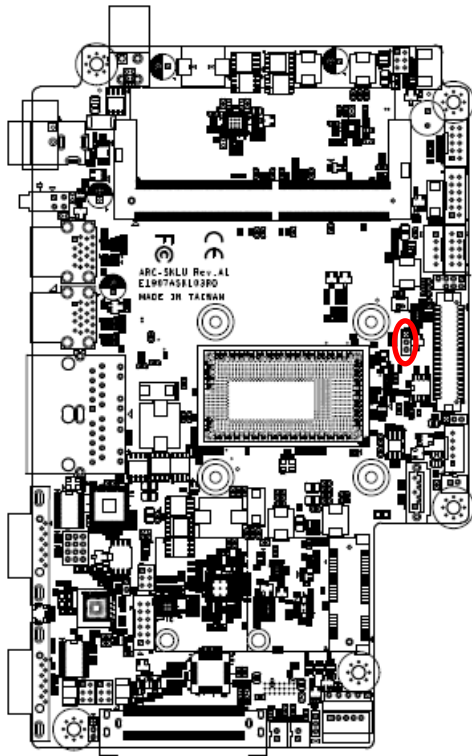

Protect*

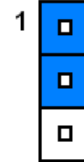

Clear CMOS

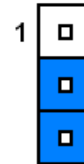

*Default

2.5.2 Serial port 1/2 pin9 signal select (JRI1/JRI2)

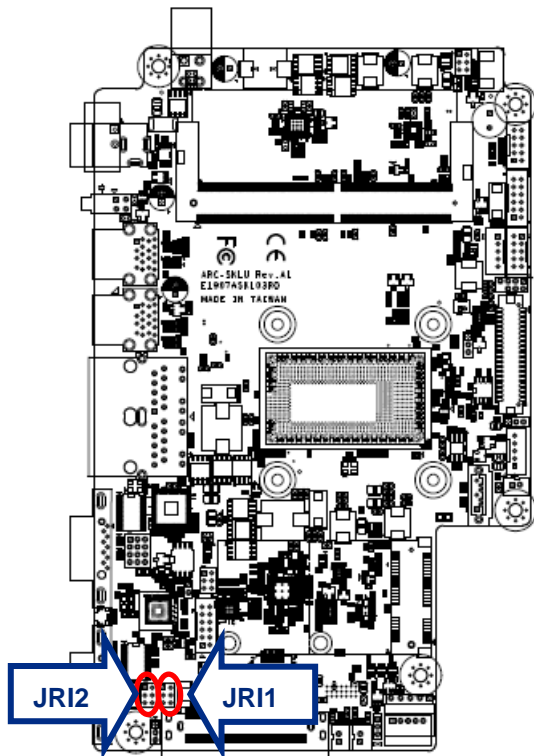

Ring*

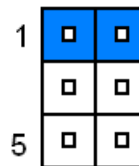

+5V

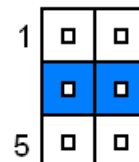

+12V

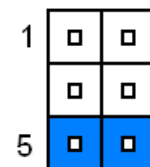

* Default

2.5.3 LCD backlight brightness adjustment (JBKLSEL1)

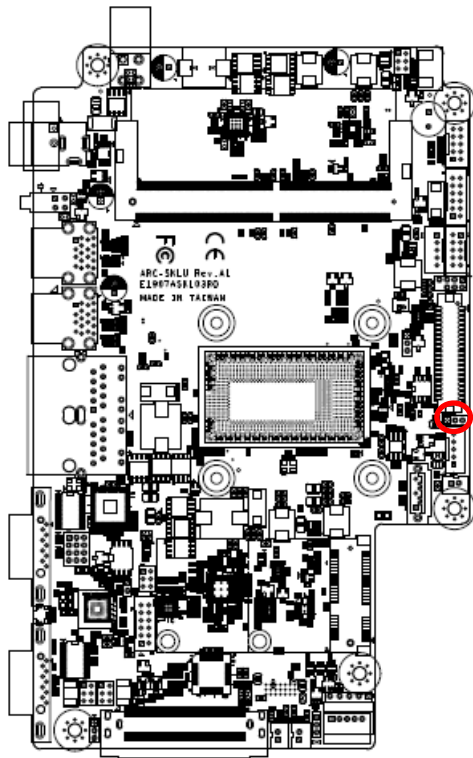

PWM Mode*

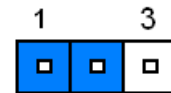

DC Mode

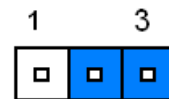

* Default

2.5.4 AT/ATX auto power on select (JAT1)

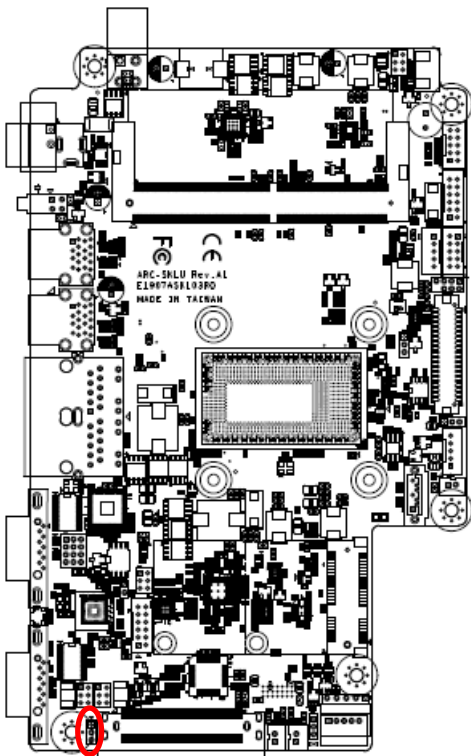

Power on by power button*

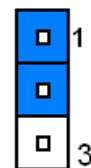

Auto power on

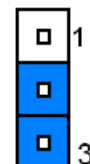

* Default

2.5.5 Serial port 1 in RS-232/422/485 mode (JCOM1_SEL1)

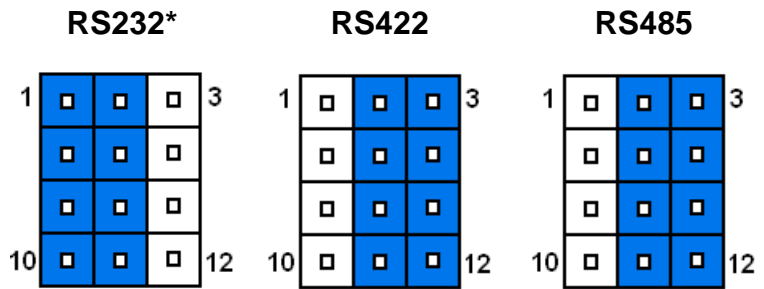
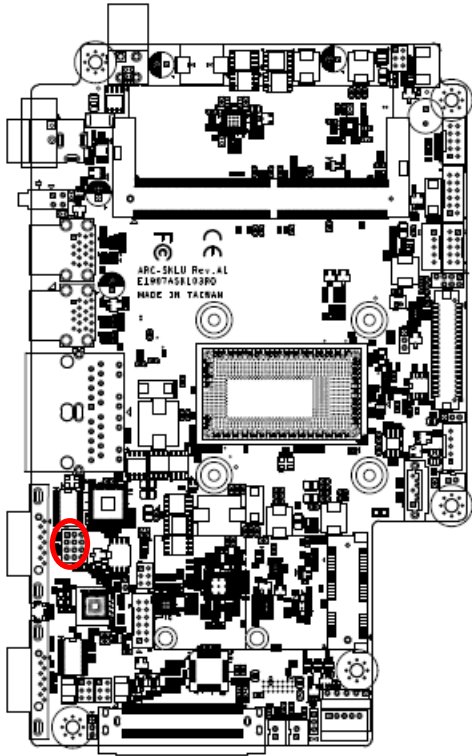

| PIN | Signal | PIN | Signal | PIN | Signal |
|-----|-------------|-----|--------|-----|--------|
| 12 | 422RX1- | 11 | COM1-4 | 10 | NDTRA# |
| 9 | 485_422TX1+ | 8 | COM1-2 | 7 | NRXDA |
| 6 | 422RX1+ | 5 | COM1-3 | 4 | NTXDA |
| 3 | 485_422TX1- | 2 | COM1-1 | 1 | NDCDA# |

Note:

This connector is available after modify the mode of COM1 in BIOS setting.

* Default

2.5.6 LCD Inverter connector (JBKL1)

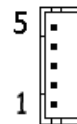
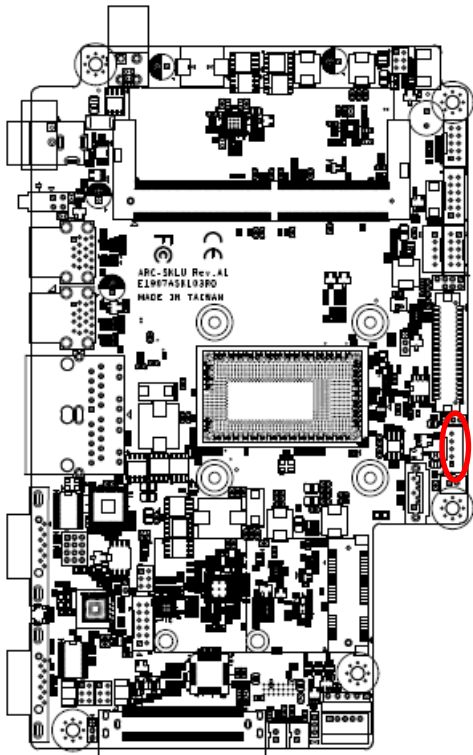

| Signal | PIN |
|---------------|-----|
| +5V | 5 |
| LVDS_BKLT_CTL | 4 |
| LVDS_BKLT_EN | 3 |
| GND | 2 |
| +12V | 1 |

2.5.7 On-board header for USB2.0 (JUSB1)

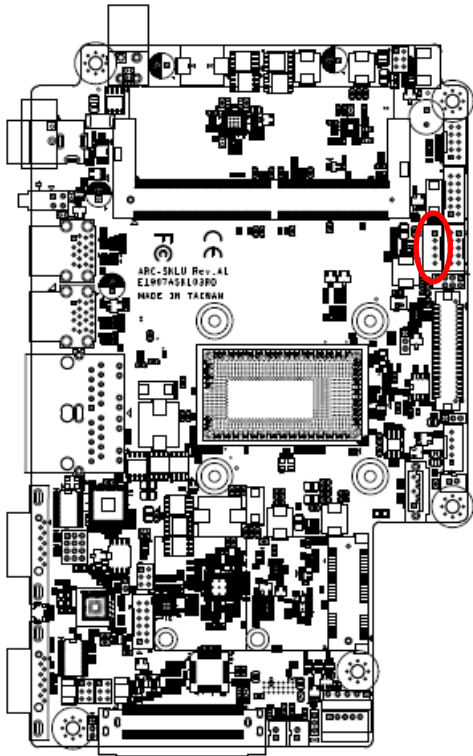

| Signal | PIN |
|--------|-----|
| +5VSB | 1 |
| USB- | 2 |
| USB+ | 3 |
| GND | 4 |
| GND | 5 |

2.5.8 On-board header for USB2.0 (JUSB2)

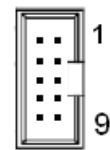
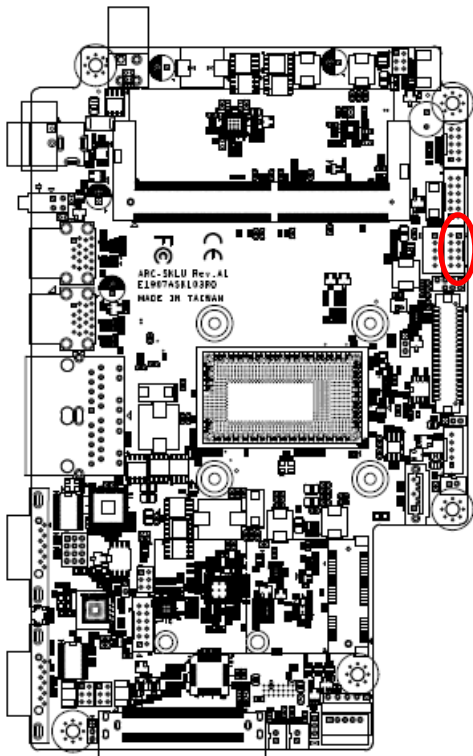

| Signal | PIN | PIN | Signal |
|--------|-----|-----|--------|
| +5VSB | 2 | 1 | +5VSB |
| USB- | 4 | 3 | USB- |
| USB+ | 6 | 5 | USB+ |
| GND | 8 | 7 | GND |
| GND | 10 | 9 | GND |

2.5.9 On-board header for USB2.0 (JUSB3)

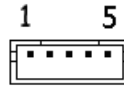
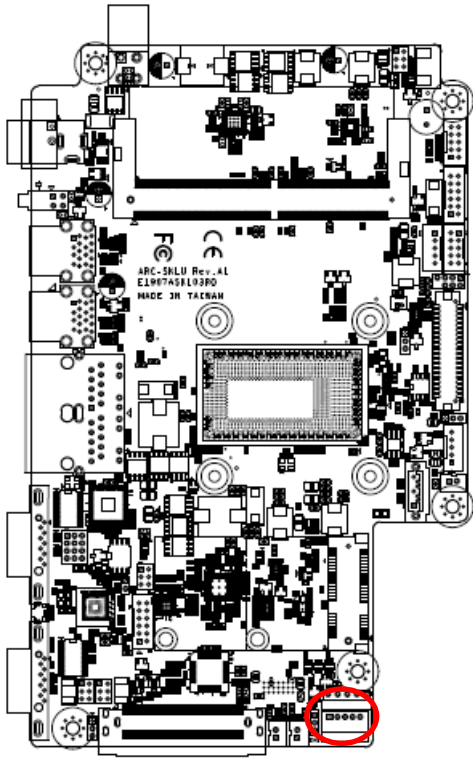

| Signal | PIN |
|--------|-----|
| +5VSB | 1 |
| USB- | 2 |
| USB+ | 3 |
| GND | 4 |
| GND | 5 |

2.5.10 Battery connector (JBAT1)

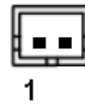
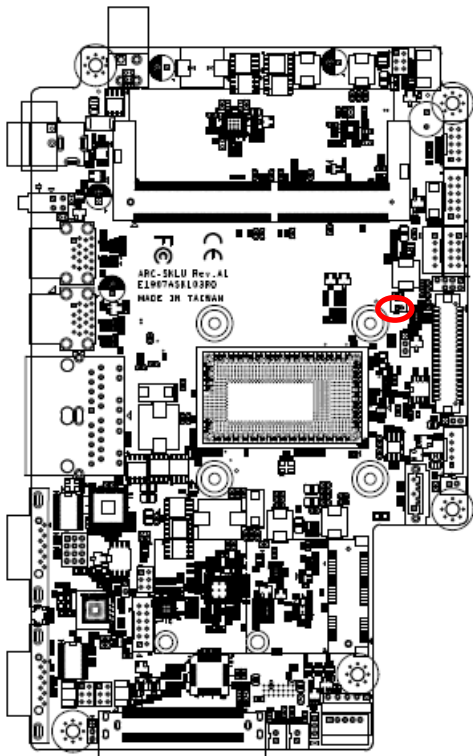

| Signal | PIN |
|---------|-----|
| +RTCBAT | 1 |
| GND | 2 |

2.5.11 LVDS connector (JLVDS1)

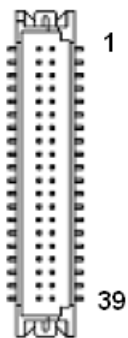
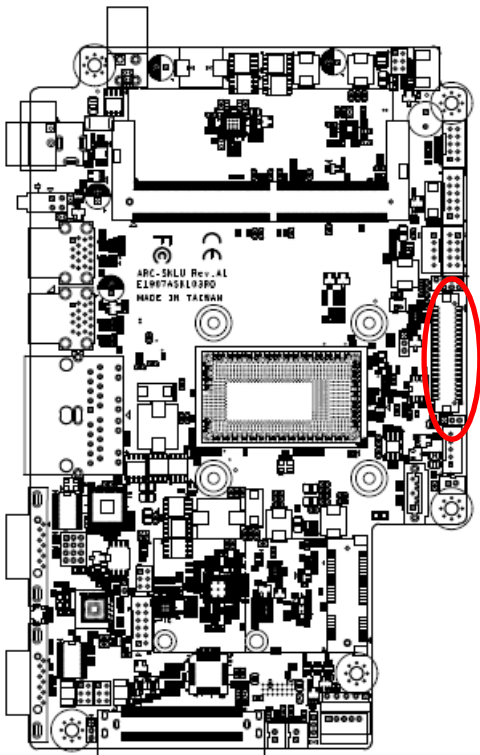

| Signal | PIN | PIN | Signal |
|--------------|-----|-----|--------------|
| +5V | 2 | 1 | +3.3V |
| +5V | 4 | 3 | +3.3V |
| NC | 6 | 5 | NC |
| GND | 8 | 7 | GND |
| LVDS_DATA0_P | 10 | 9 | LVDS_DATA1_P |
| LVDS_DATA0_N | 12 | 11 | LVDS_DATA1_N |
| GND | 14 | 13 | GND |
| LVDS_DATA2_P | 16 | 15 | LVDS_DATA3_P |
| LVDS_DATA2_N | 18 | 17 | LVDS_DATA3_N |
| GND | 20 | 19 | GND |
| LVDS_DATA4_P | 22 | 21 | LVDS_DATA5_P |
| LVDS_DATA4_N | 24 | 23 | LVDS_DATA5_N |
| GND | 26 | 25 | GND |
| LVDS_DATA6_P | 28 | 27 | LVDS_DATA7_P |
| LVDS_DATA6_N | 30 | 29 | LVDS_DATA7_N |
| GND | 32 | 31 | GND |
| LVDS_CLK1_P | 34 | 33 | LVDS_CLK2_P |
| LVDS_CLK1_N | 36 | 35 | LVDS_CLK2_N |
| GND | 38 | 37 | GND |
| +12V | 40 | 39 | +12V |

2.5.12 Speaker_R (JSPR1)

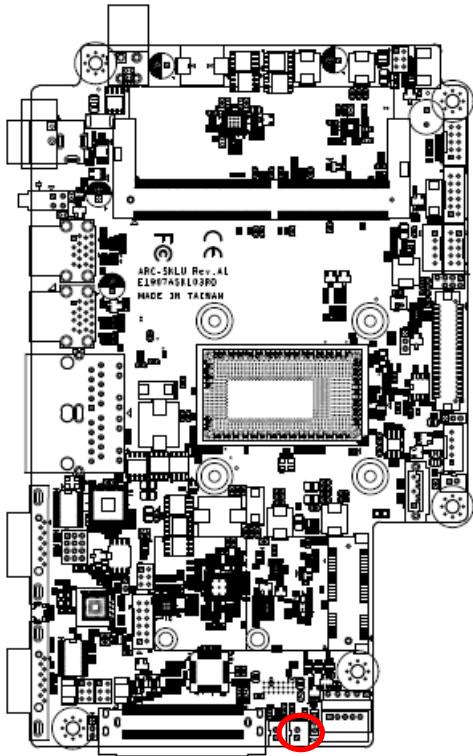

| Signal | PIN |
|--------|-----|
| SPK_R- | 2 |
| SPK_R+ | 1 |

2.5.13 Speaker_L (JSPL1)

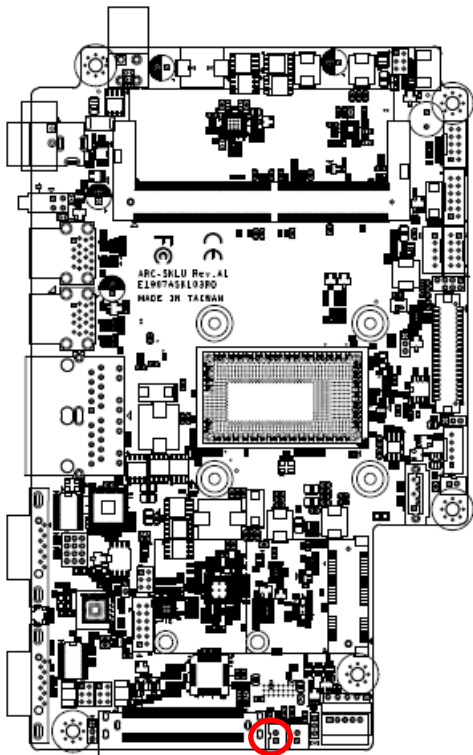

| Signal | PIN |
|--------|-----|
| SPK_L- | 2 |
| SPK_L+ | 1 |

2.5.14 SPI connector (JSPI1)

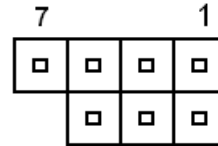
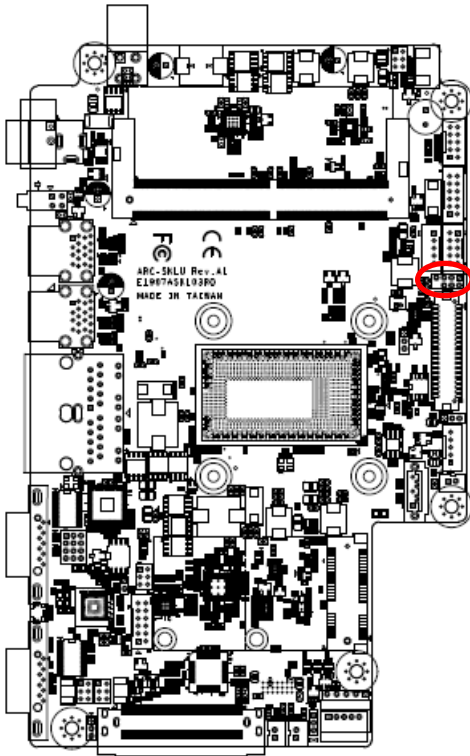

| Signal | PIN | PIN | Signal |
|-----------|-----|-----|---------|
| +3.3VSB | 1 | 2 | GND |
| SPI0_CS0# | 3 | 4 | SPI_CLK |
| SPI_SO | 5 | 6 | SPI_SI |
| HOLD# | 7 | | |

2.5.15 EC Debug connector (JEC1)

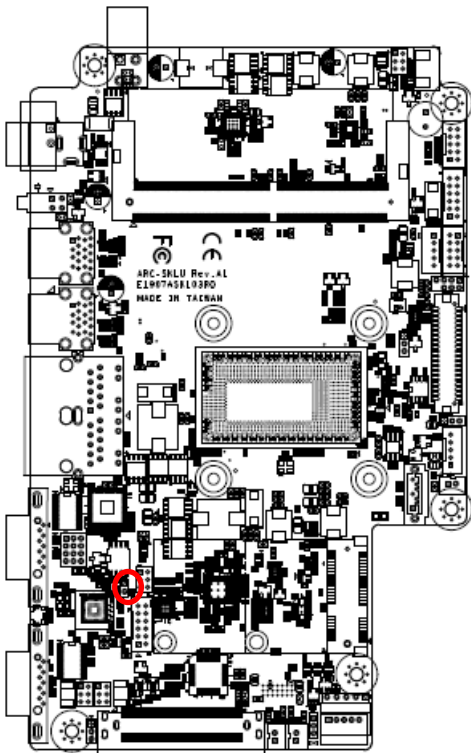

| Signal | PIN |
|----------------|-----|
| EC_SMCLK_DEBUG | 1 |
| EC_SMDAT_DEBUG | 2 |

2.5.16 LCD backlight brightness adjustment (JBLK_CTRL1)

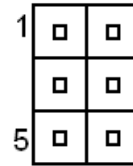
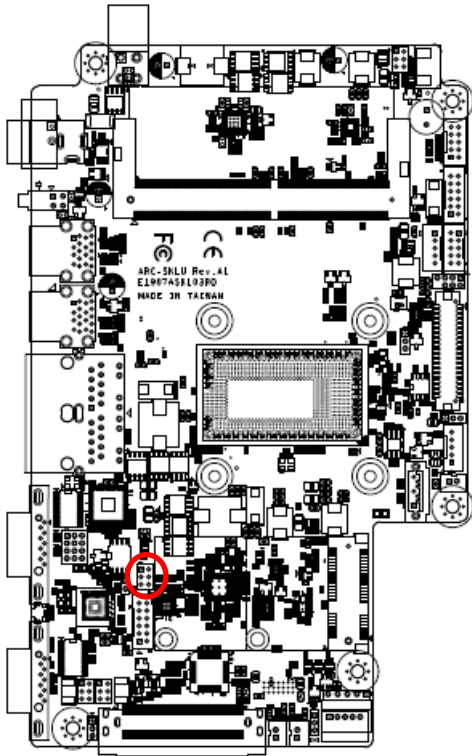

| PIN | Signal | Note |
|-----|------------|---|
| 1-2 | BLK_VR_MOD | VR must select 10K/1% |
| 3-4 | BLK_BRI_UP | Low pulse button for backlight brighter |
| 5-6 | BLK_BRI_DN | Low pulse button for backlight dim |

2.5.17 UPS-GPIO connector (JUPS1)

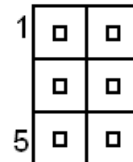
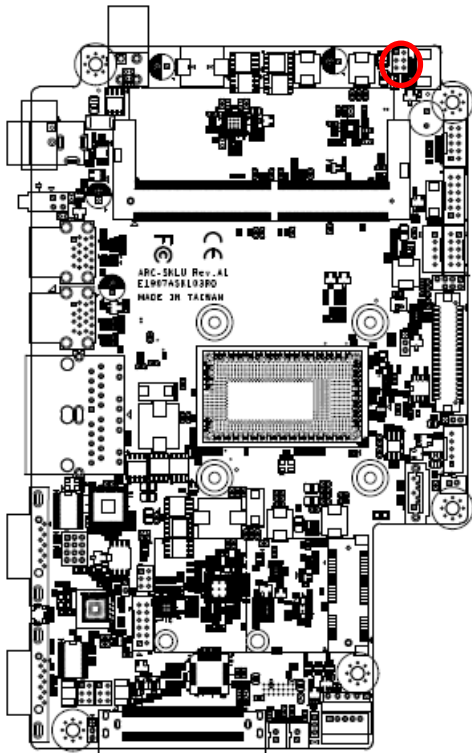

| Signal | PIN | PIN | Signal |
|---------|-----|-----|----------|
| OFF_PC# | 1 | 2 | SMB_CLK |
| GND | 3 | 4 | SMB_DATA |
| GND | 5 | 6 | GND |

2.5.18 B2B connector (JB2B1)

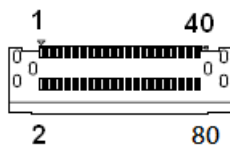
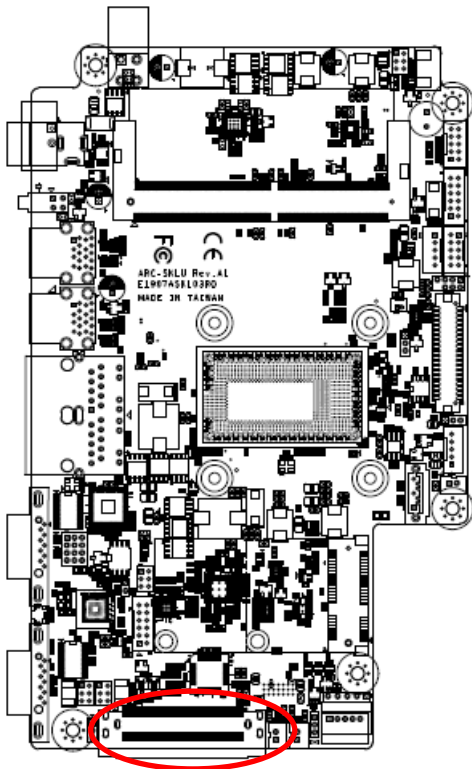

| Signal | PIN | PIN | Signal |
|--------------|-----|-----|--------|
| GND | 1 | 41 | GND |
| GND | 2 | 42 | GND |
| +12V | 3 | 43 | GND |
| +12V | 4 | 44 | GND |
| GND | 5 | 45 | GND |
| LPC_SERIRQ | 6 | 46 | +5VSB |
| LPC_LFRAME# | 7 | 47 | +5VSB |
| CLK3_LPC_B2B | 8 | 48 | +5VSB |
| LPC_AD0 | 9 | 49 | +5VSB |
| LPC_AD1 | 10 | 50 | +5VSB |

| Signal | PIN | PIN | Signal |
|----------------|-----|-----|--------------------|
| LPC_AD2 | 11 | 51 | GND |
| LPC_AD3 | 12 | 52 | USB_PP8 |
| PS_ON_B2B | 13 | 53 | USB_PN8 |
| PLT_RST# | 14 | 54 | GND |
| PCH_SLP_S3# | 15 | 55 | SMBCLK |
| HDMI_HPD | 16 | 56 | SMBDATA |
| GND | 17 | 57 | GND |
| HDMI1_CTRL_CLK | 18 | 58 | BOARD_ID |
| HDMI1_CTRL_DAT | 19 | 59 | PCIEUSB3_PONRSTB |
| GND | 20 | 60 | PCIEUSB3_SMIB_INT# |
| HDMI1_TXN_2 | 21 | 61 | B2BPCIE_WAKE# |
| HDMI1_TXP_2 | 22 | 62 | RST_B2BPCIE# |
| GND | 23 | 63 | B2BPCIE_CLK_REQ# |
| HDMI1_TXN_1 | 24 | 64 | GND |
| HDMI1_TXP_1 | 25 | 65 | PCIE_TXN8 |
| GND | 26 | 66 | PCIE_TXP8 |
| HDMI1_TXN_0 | 27 | 67 | GND |
| HDMI1_TXP_0 | 28 | 68 | PCIE_RXN8 |
| GND | 29 | 69 | PCIE_RXP8 |
| HDMI1_CLKN | 30 | 70 | GND |
| HDMI1_CLKP | 31 | 71 | CLK_B2BPCIE_N2 |
| GND | 32 | 72 | CLK_B2BPCIE_P2 |
| GND | 33 | 73 | GND |
| MIC_RIN | 34 | 74 | GND |
| MIC_LIN | 35 | 75 | MIC1_JD |
| GND | 36 | 76 | GND |
| LINEOUT1_JD | 37 | 77 | LINE1_JD |
| LINEOUT_R | 38 | 78 | LINE1_RIN |
| LINEOUT_L | 39 | 79 | LNE1_LIN |
| GND | 40 | 80 | GND |

2.5.19 SATA Power connector (SATAPW1)

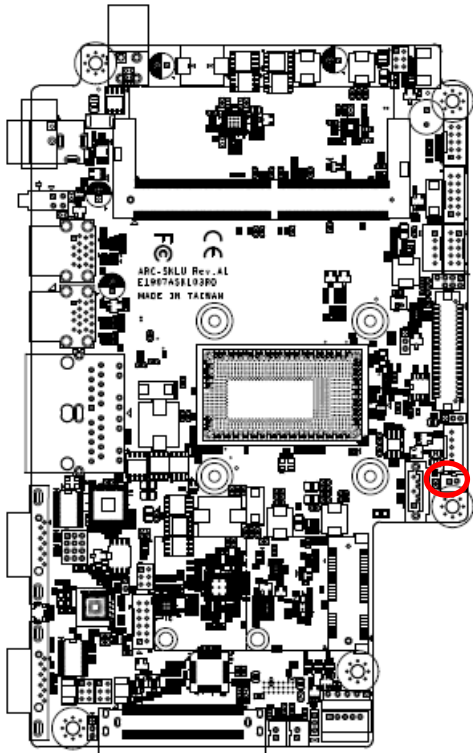

| Signal | PIN |
|--------|-----|
| GND | 1 |
| +5V | 2 |

2.5.20 General purpose I/O connector (JGPIO1)

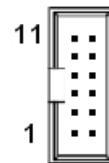
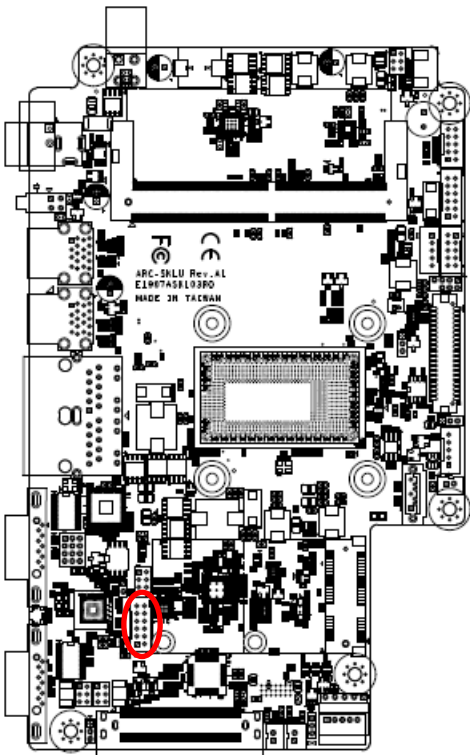

| Signal | PIN | PIN | Signal |
|----------|-----|-----|----------|
| +3.3V | 11 | 12 | GND |
| SMB_DATA | 9 | 10 | SMB_CLK |
| DIO_GP23 | 7 | 8 | DIO_GP13 |
| DIO_GP22 | 5 | 6 | DIO_GP12 |
| DIO_GP21 | 3 | 4 | DIO_GP11 |
| DIO_GP20 | 1 | 2 | DIO_GP10 |

2.5.21 Miscellaneous setting connector (JFP2)

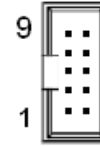
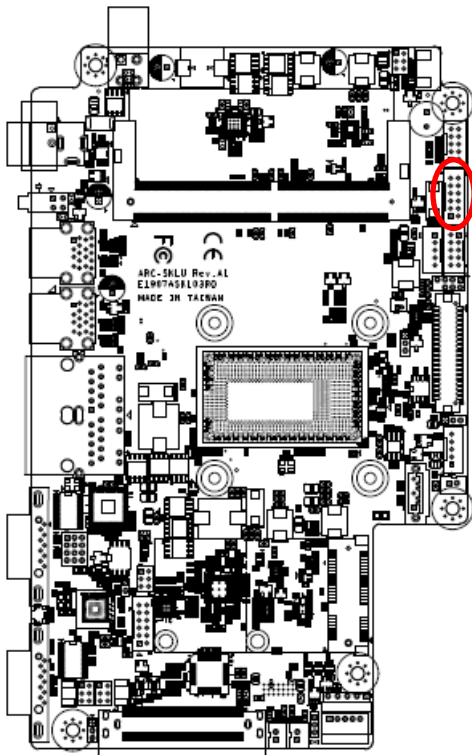

| Signal | PIN | PIN | Signal |
|---------|-----|-----|------------|
| FP_LED1 | 9 | 10 | FP_LED2 |
| PWRBTN | 7 | 8 | LED_ONOFF# |
| BRI_DN# | 5 | 6 | BRI_UP# |
| VOL_DN# | 3 | 4 | VOL_UP# |
| GND | 1 | 2 | +3V |

2.5.22 LED connector (JLED1)

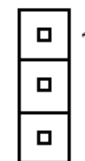
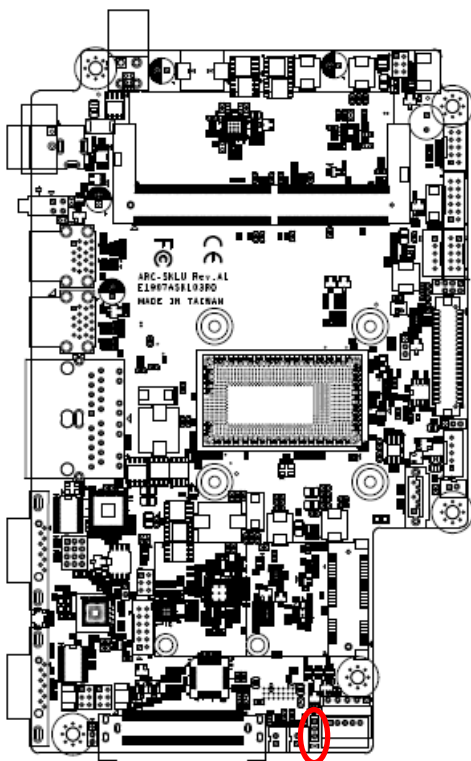

| Signal | PIN |
|--------------|-----|
| +5VSB | 1 |
| LED_BOARD_EN | 2 |
| GND | 3 |

2.5.23 Serial port 1 connector (COM1)

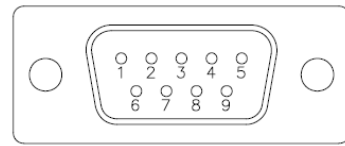
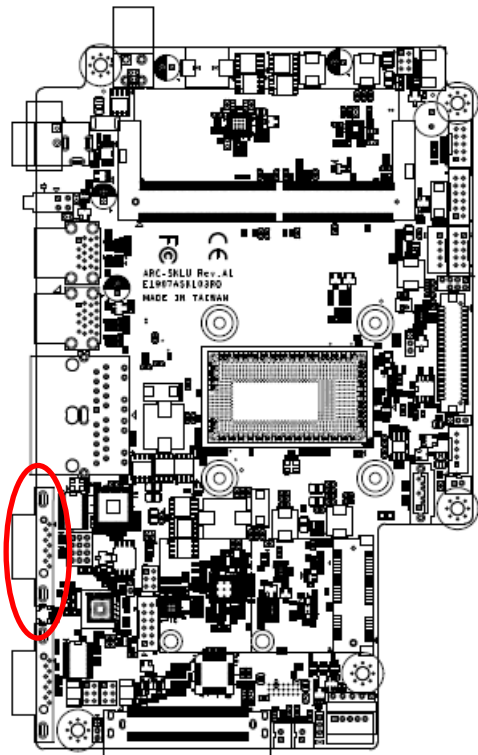

RS-232

| Signal | PIN | PIN | Signal |
|--------|-----|-----|--------|
| DCD# | 1 | 6 | DSR# |
| RXD | 2 | 7 | RTS# |
| TXD | 3 | 8 | CTS# |
| DTR# | 4 | 9 | RI# |
| GND | 5 | | |

RS-422

| Signal | PIN | PIN | Signal |
|---------|-----|-----|--------|
| 422_Tx- | 1 | 6 | NC |
| 422_Tx+ | 2 | 7 | NC |
| 422_Rx+ | 3 | 8 | NC |
| 422_Rx- | 4 | 9 | NC |
| GND | 5 | | |

RS-485

| Signal | PIN | PIN | Signal |
|---------|-----|-----|--------|
| 485_Tx- | 1 | 6 | NC |
| 485_Tx+ | 2 | 7 | NC |
| NC | 3 | 8 | NC |
| NC | 4 | 9 | NC |
| GND | 5 | | |

Note:

RS-232 mode is default, RS-422 and RS-485 changed setting by jumper(JCOM_SEL1).

2.6 ARC-SKLU DB-B Overviews

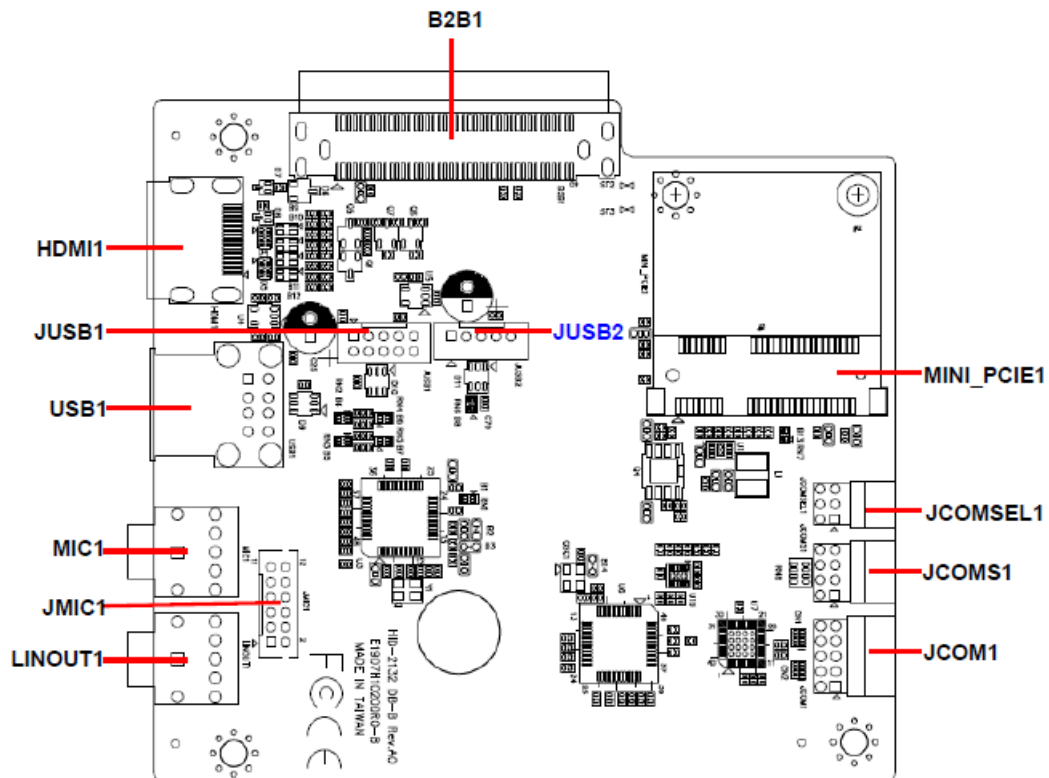

2.7 ARC-SKLU DB-B Jumper and Connector list

Jumpers

| Label | Function | Note |
|----------|--------------------------------------|----------------------------|
| JCOMSEL1 | Serial port 1 in RS-232/422/485 mode | 3 x 2 header, pitch 2.00mm |

Connectors

| Label | Function | Note |
|------------|--|----------------------------|
| JCOM1 | Serial port 1 connector | 5 x 2 header, pitch 2.00mm |
| JCOMS1 | RS-422/RS-485 Termination Resistance connector | 4 x 2 header, pitch 2.00mm |
| B2B1 | B2B connector | 40 x 2 wafer, pitch 0.80mm |
| HDMI1 | HDMI connector | |
| MIC1 | Mic-in audio jack | |
| JMIC1 | Audio connector (Reserved) | 6 x 2 wafer, pitch 2.00mm |
| LINOUT1 | Line-out audio jack | |
| MINI_PCIE1 | Mini-PCIe connector | |
| USB1 | USB connector x 2 | |
| JUSB1 | USB connector 1 (Reserved) | 5 x 2 wafer, pitch 2.00mm |
| JUSB2 | USB connector 2 | 5 x 1 wafer, pitch 2.00mm |

2.8 ARC-SKLU DB-B Jumpers & Connectors settings

2.8.1 Serial port 1 in RS-232/422/485 mode (JCOMSEL1)

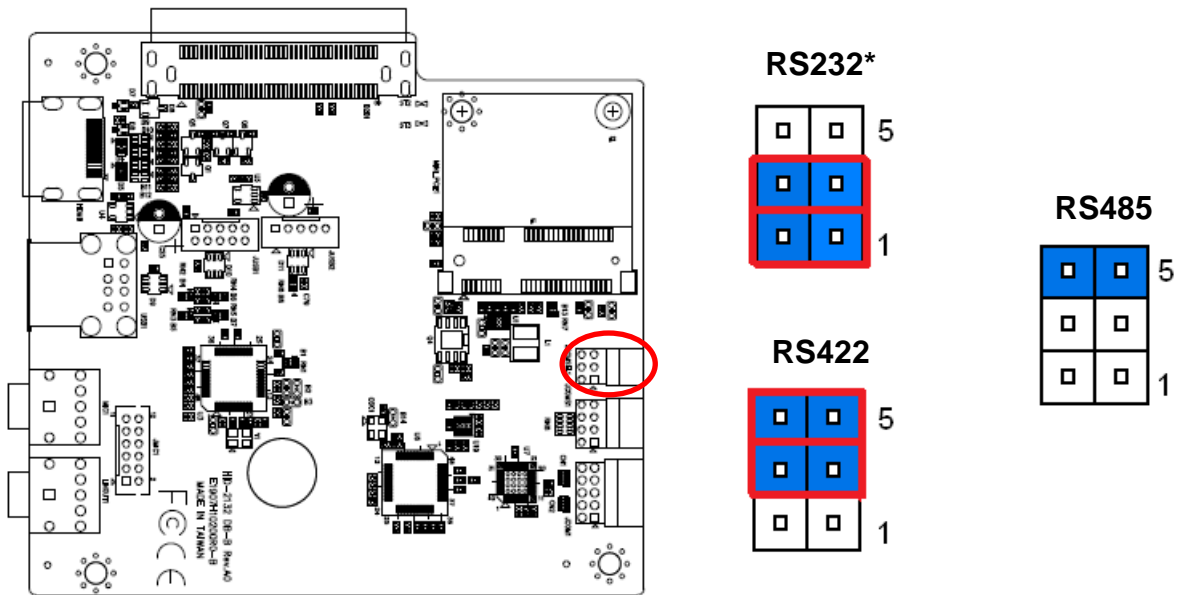

*Default

2.8.2 Audio connector (JM1C1)

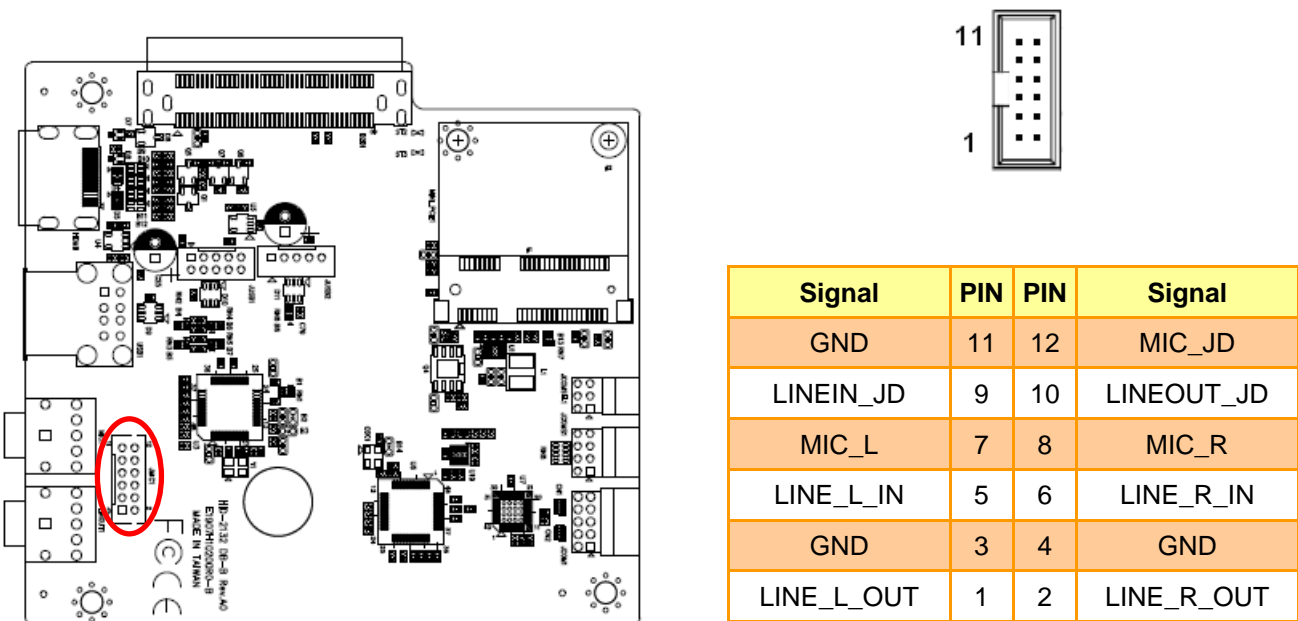

2.8.2.1 Signal Description – Audio connector (JM1C1)

| Signal | Signal Description |
|------------|--------------------------------|
| LINEOUT_JD | AUDIO Out(ROUT/LOUT) sense pin |
| MIC_JD | MIC IN (MIC_RIN/LIN) sense pin |

Note:

Line in function unavailable.

2.8.3 Serial port 1 connector (JCOM1)

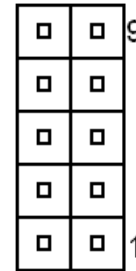
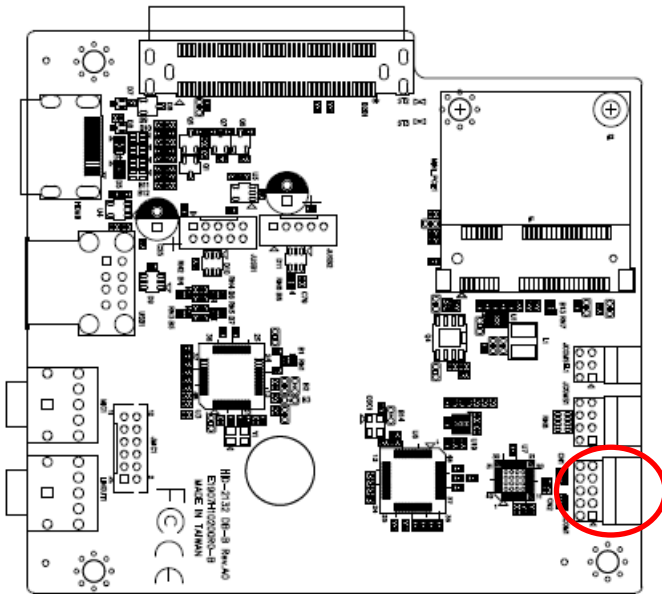

| Signal | PIN | PIN | Signal |
|--------|-----|-----|--------|
| NC | 10 | 9 | NR11# |
| NCTS1# | 8 | 7 | NRTS1# |
| NDSR1# | 6 | 5 | GND |
| NDTR1# | 4 | 3 | NTXD1 |
| NRXD1 | 2 | 1 | NDCD1# |

2.8.4 RS-422/RS-485 Termination Resistance connector (JCOMS1)

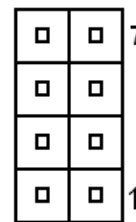
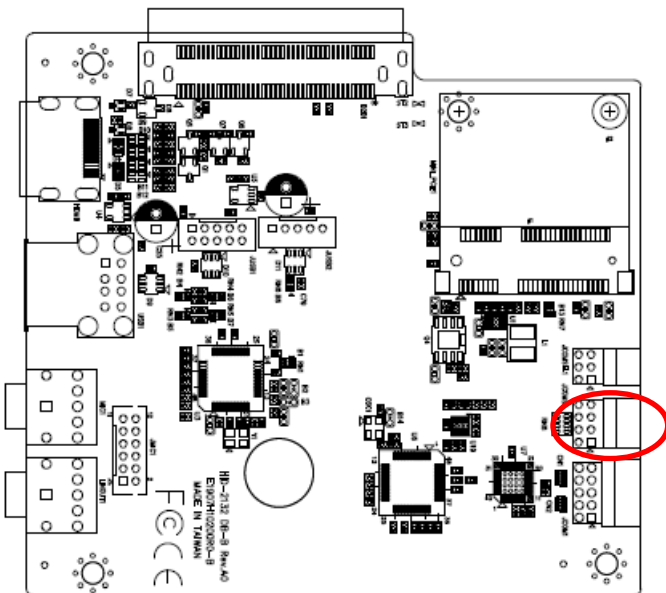

| Signal | PIN | PIN | Signal |
|--------|-----|-----|--------|
| GND | 8 | 7 | NDTR1# |
| GND | 6 | 5 | NDCD1# |
| +5V | 4 | 3 | NRXD1 |
| +5V | 2 | 1 | NTXD1 |

2.8.5 B2B connector (B2B1)

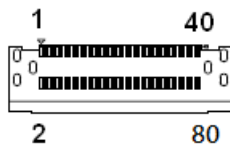
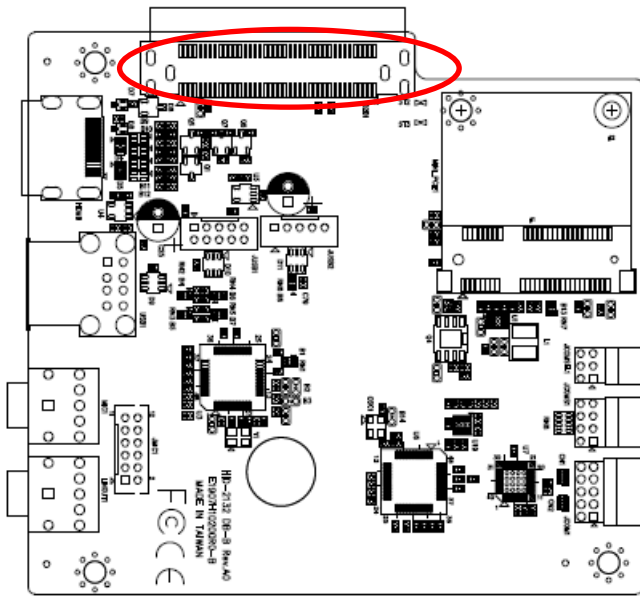

| Signal | PIN | PIN | Signal |
|------------|-----|-----|--------|
| GND | 1 | 41 | GND |
| GND | 2 | 42 | GND |
| NC | 3 | 43 | GND |
| NC | 4 | 44 | GND |
| GND | 5 | 45 | GND |
| LPC_SERIRQ | 6 | 46 | +5VSB |
| LPC_FRAME# | 7 | 47 | +5VSB |
| LPC_CLK | 8 | 48 | +5VSB |
| LPC_AD0 | 9 | 49 | +5VSB |
| LPC_AD1 | 10 | 50 | +5VSB |

| Signal | PIN | PIN | Signal |
|----------------|-----|-----|---------------|
| LPC_AD2 | 11 | 51 | GND |
| LPC_AD3 | 12 | 52 | USB_DP_A |
| PS_ON | 13 | 53 | USB_DN_A |
| PLT_RST# | 14 | 54 | GND |
| NC | 15 | 55 | SMBDATA |
| HDMI_HPD0 | 16 | 56 | SMBCLK |
| GND | 17 | 57 | GND |
| HDMI1_CTRLCLK | 18 | 58 | BOARD_ID |
| HDMI1_CTRLDATA | 19 | 59 | PONRSTB |
| GND | 20 | 60 | NC |
| HDMI1_TXN2 | 21 | 61 | MPCIE_WAKE# |
| HDMI1_TXP2 | 22 | 62 | MPCIE_RESET# |
| GND | 23 | 63 | MPCIE_CLKREQ# |
| HDMI1_TXN1 | 24 | 64 | GND |
| HDMI1_TXP1 | 25 | 65 | MPCIE1_TX- |
| GND | 26 | 66 | MPCIE1_TX+ |
| HDMI1_TXN0 | 27 | 67 | GND |
| HDMI1_TXP0 | 28 | 68 | MPCIE1_RX- |
| GND | 29 | 69 | MPCIE1_RX+ |
| HDMI1_CLK_N | 30 | 70 | GND |
| HDMI1_CLK_P | 31 | 71 | MPCIE_CLK- |
| GND | 32 | 72 | MPCIE_CLK+ |
| GND | 33 | 73 | GND |
| MIC_R | 34 | 74 | GND |
| MIC_L | 35 | 75 | MIC_JD |
| GND | 36 | 76 | GND |
| LINEOUT_JD | 37 | 77 | LINEIN_JD |
| LINE_R_OUT | 38 | 78 | LINE_R_IN |
| LINE_L_OUT | 39 | 79 | LINE_L_IN |
| GND | 40 | 80 | GND |

2.8.6 USB connector 2 (JUSB2)

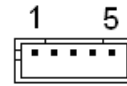
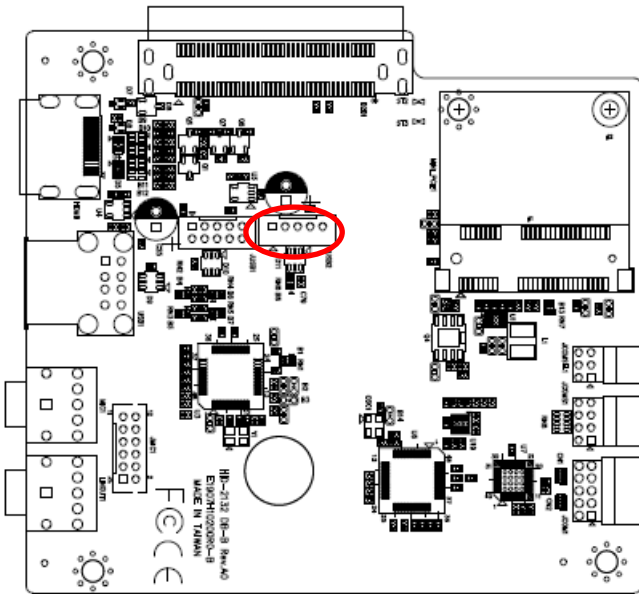

| Signal | PIN |
|------------|-----|
| USBVCC2 | 1 |
| USB_DN_R_3 | 2 |
| USB_DP_R_3 | 3 |
| GND | 4 |
| GND | 5 |