

# ECM-KBLU

7th Gen Intel® Core™ SoC Processor i7/i5/i3/Celeron  
3.5" Micro Module

## User's Manual

---

3<sup>rd</sup> Ed –24 March 2020

## FCC Statement



THIS DEVICE COMPLIES WITH PART 15 FCC RULES. OPERATION IS SUBJECT TO THE FOLLOWING TWO CONDITIONS:

- (1) THIS DEVICE MAY NOT CAUSE HARMFUL INTERFERENCE.
- (2) THIS DEVICE MUST ACCEPT ANY INTERFERENCE RECEIVED INCLUDING INTERFERENCE THAT MAY CAUSE UNDESIRE OPERATION.

THIS EQUIPMENT HAS BEEN TESTED AND FOUND TO COMPLY WITH THE LIMITS FOR A CLASS "A" DIGITAL DEVICE, PURSUANT TO PART 15 OF THE FCC RULES.

THESE LIMITS ARE DESIGNED TO PROVIDE REASONABLE PROTECTION AGAINST HARMFUL INTERFERENCE WHEN THE EQUIPMENT IS OPERATED IN A COMMERCIAL ENVIRONMENT. THIS EQUIPMENT GENERATES, USES, AND CAN RADIATE RADIO FREQUENCY ENERGY AND, IF NOT INSTALLED AND USED IN ACCORDANCE WITH THE INSTRUCTION MANUAL, MAY CAUSE HARMFUL INTERFERENCE TO RADIO COMMUNICATIONS.

OPERATION OF THIS EQUIPMENT IN A RESIDENTIAL AREA IS LIKELY TO CAUSE HARMFUL INTERFERENCE IN WHICH CASE THE USER WILL BE REQUIRED TO CORRECT THE INTERFERENCE AT HIS OWN EXPENSE.

## Notice

This guide is designed for experienced users to setup the system within the shortest time. For detailed information, please always refer to the electronic user's manual.

## Copyright Notice

Copyright © 2020 ALL RIGHTS RESERVED.

No part of this document may be reproduced, copied, translated, or transmitted in any form or by any means, electronic or mechanical, for any purpose, without the prior written permission of the original manufacturer.

## Trademark Acknowledgement

Brand and product names are trademarks or registered trademarks of their respective owners.

## Disclaimer

We reserve the right to make changes, without notice, to any product, including circuits and/or software described or contained in this manual in order to improve design and/or performance. We assume no responsibility or liability for the use of the described product(s), conveys no license or title under any patent, copyright, or masks work rights to these products, and makes no representations or warranties that

these products are free from patent, copyright, or mask work right infringement, unless otherwise specified. Applications that are described in this manual are for illustration purposes only. We make no representation or warranty that such application will be suitable for the specified use without further testing or modification.

### **Life Support Policy**

OUR PRODUCTS ARE NOT FOR USE AS CRITICAL COMPONENTS IN LIFE SUPPORT DEVICES OR SYSTEMS WITHOUT THE PRIOR WRITTEN APPROVAL.

As used herein:

1. Life support devices or systems are devices or systems which, (a) are intended for surgical implant into body, or (b) support or sustain life and whose failure to perform, when properly used in accordance with instructions for use provided in the labeling, can be reasonably expected to result in significant injury to the user.
2. A critical component is any component of a life support device or system whose failure to perform can be reasonably expected to cause the failure of the life support device or system, or to affect its safety or effectiveness.

### **A Message to the Customer**

#### ***Customer Services***

Each and every product is built to the most exacting specifications to ensure reliable performance in the harsh and demanding conditions typical of industrial environments. Whether your new device is destined for the laboratory or the factory floor, you can be assured that your product will provide the reliability and ease of operation.

Your satisfaction is our primary concern. Here is a guide to our customer services. To ensure you get the full benefit of our services, please follow the instructions below carefully.

#### ***Technical Support***

We want you to get the maximum performance from your products. So if you run into technical difficulties, we are here to help. For the most frequently asked questions, you can easily find answers in your product documentation. These answers are normally a lot more detailed than the ones we can give over the phone. So please consult the user's manual first.

## ECM-KBLU User's Manual

### *Product Warranty*

We warrant to you, the original purchaser, that each of its products will be free from defects in materials and workmanship for two years from the date of purchase.

This warranty does not apply to any products which have been repaired or altered by persons other than repair personnel authorized or which have been subject to misuse, abuse, accident or improper installation. We assume no liability under the terms of this warranty as a consequence of such events. Because of our high quality-control standards and rigorous testing, most of our customers never need to use our repair service. If any of our products is defective, it will be repaired or replaced at no charge during the warranty period. For out-of-warranty repairs, you will be billed according to the cost of replacement materials, service time, and freight. Please consult your dealer for more details. If you think you have a defective product, follow these steps:

1. Collect all the information about the problem encountered. (For example, CPU type and speed, our products model name, hardware & BIOS revision number, other hardware and software used, etc.) Note anything abnormal and list any on-screen messages you get when the problem occurs.
2. Call your dealer and describe the problem. Please have your manual, product, and any helpful information available.
3. If your product is diagnosed as defective, obtain an RMA (return material authorization) number from your dealer. This allows us to process your good return more quickly.
4. Carefully pack the defective product, a complete Repair and Replacement Order Card and a photocopy proof of purchase date (such as your sales receipt) in a shippable container. A product returned without proof of the purchase date is not eligible for warranty service.
5. Write the RMA number visibly on the outside of the package and ship it prepaid to your dealer.

# Content

<b>1. Getting Started</b>	<b>8</b>
1.1 Safety Precautions	8
1.2 Packing List	8
1.3 Document Amendment History	9
1.4 Manual Objectives	10
1.5 System Specifications	11
1.6 Architecture Overview—Block Diagram	14
<b>2. Hardware Configuration</b>	<b>15</b>
2.1 Product Overview	16
2.2 Jumper and Connector List	17
2.3 Setting Jumpers & Connectors	19
2.3.1 Serial port 1 pin9 signal select (JRI1)	19
2.3.2 Clear CMOS (JBAT1)	19
2.3.3 LCD backlight brightness adjustment (JBKL_SEL1)	20
2.3.4 AT/ATX Input power select (JAT1)	20
2.3.5 LCD inverter connector (JBKL1)	21
2.3.6 CPU fan connector (CPU_FAN1)	21
2.3.7 System fan connector (SYS_FAN1)	22
2.3.8 Serial port 2/3/4/5/6 connector (JCOM2/3/4/5/6)	22
2.3.9 Serial port 2 in RS-422/485 mode (J422_485)	23
2.3.10 General purpose I/O connector (JDIO1)	23
2.3.11 SATA Power connector (SATA_PWR1)	24
2.3.12 Power connector (PWR1)	24
2.3.13 LVDS connector (JLVDS1)	25
2.3.14 USB2.0 connector (JUSB56)	26
2.3.15 SPI connector (JSPI1)	26
2.3.16 EC Debug connector (JEC_ROM1)	27
2.3.17 Battery connector (BAT1)	27
2.3.18 LPC connector (JLPC1)	28
2.3.19 Front Panel connector (JFP1)	28
2.3.20 PC Buzzer connector (JBZ1)	29
2.3.21 Audio connector (JAUDIO1)	29
2.3.21.1 Signal Description – Audio connector (JAUDIO1)	29
2.4 AUX-032 User's Guide	30
2.4.1 Jumper and Connector Layout	30
2.4.2 Jumper and Connector List	30

## ECM-KBLU User's Manual

2.4.3	Setting Jumper and Connector .....	31
<b>3</b>	<b>BIOS Setup .....</b>	<b>32</b>
3.1	Introduction .....	33
3.2	Starting Setup .....	33
3.3	Using Setup .....	34
3.4	Getting Help .....	35
3.5	In Case of Problems .....	35
3.6	BIOS setup .....	36
3.6.1	Main Menu .....	36
3.6.1.1	System Language .....	37
3.6.1.2	System Date .....	37
3.6.1.3	System Time .....	37
3.6.2	Advanced Menu .....	37
3.6.2.1	CPU Configuration .....	38
3.6.2.2	Power & Performance .....	39
3.6.2.2.1	CPU – Power Management Control .....	39
3.6.2.2.2	GT – Power Management Control .....	41
3.6.2.3	PCH-FW Configuration .....	42
3.6.2.3.1	Firmware Update Configuration .....	42
3.6.2.3.2	PTT Configuration .....	43
3.6.2.4	Trusted Computing .....	44
3.6.2.5	APCI Settings .....	44
3.6.2.6	IT8528 Super IO Configuration .....	45
3.6.2.6.1	Serial Port 1 Configuration .....	46
3.6.2.6.2	Serial Port 2 Configuration .....	47
3.6.2.6.3	Serial Port 3 Configuration .....	47
3.6.2.6.4	Serial Port 4 Configuration .....	48
3.6.2.6.5	Serial Port 5 Configuration .....	48
3.6.2.6.6	Serial Port 6 Configuration .....	49
3.6.2.7	HW Monitor .....	49
3.6.2.8	S5 RTC Wake Settings .....	50
3.6.2.9	Serial Port Console Redirection .....	50
3.6.2.9.1	Legacy Console Redirection Settings .....	51
3.6.2.10	Intel TXT Configuration .....	51
3.6.2.11	Network Stack Configuration .....	52
3.6.2.12	CSM Configuration .....	52
3.6.2.13	NVMe Configuration .....	53
3.6.2.14	USB Configuration .....	53
3.6.3	Chipset .....	55
3.6.3.1	System Agent (SA) Configuration .....	55

3.6.3.1.1	Graphics Configuration .....	56
3.6.3.2	PCH-IO Configuration.....	57
3.6.3.2.1	PCI Express Configuration .....	58
3.6.3.2.2	SATA And RST Configuration .....	62
3.6.3.2.3	USB Configuration .....	63
3.6.3.2.4	HD Audio Configuration .....	64
3.6.4	Security.....	64
3.6.4.1	Secure Boot.....	65
3.6.4.1.1	Key Management.....	66
3.6.5	Boot .....	66
3.6.6	Save and exit.....	67
3.6.6.1	Save Changes and Reset.....	68
3.6.6.2	Discard Changes and Reset.....	68
3.6.6.3	Restore Defaults .....	68
3.6.6.4	Launch EFI Shell from filesystem device .....	68
<b>4.</b>	<b>Drivers Installation.....</b>	<b>69</b>
4.1	Install Chipset Driver .....	70
4.2	Install ME Driver.....	71
4.3	Install VGA Driver.....	72
4.4	Install Audio Driver (For Realtek ALC892) .....	73
4.5	Install Ethernet Driver.....	74
4.6	Install Serial IO Driver .....	75
4.7	Install IRST Driver.....	76
<b>5.</b>	<b>Mechanical Drawing .....</b>	<b>78</b>

# 1. Getting Started

## 1.1 Safety Precautions

### Warning!



Always completely disconnect the power cord from your chassis whenever you work with the hardware. Do not make connections while the power is on. Sensitive electronic components can be damaged by sudden power surges. Only experienced electronics personnel should open the PC chassis.

### Caution!



Always ground yourself to remove any static charge before touching the CPU card. Modern electronic devices are very sensitive to static electric charges. As a safety precaution, use a grounding wrist strap at all times. Place all electronic components in a static-dissipative surface or static-shielded bag when they are not in the chassis.

## 1.2 Packing List

Before you begin installing your single board, please make sure that the following materials have been shipped:

- 1 x 3.5" ECM-KBLU Micro Module
- 1 x AUX-032 daughter board
- 1 x Cable set contains the followings:
  - 1 x Audio cable (12pin,2.0 pitch)
  - 1 x USB 2.0 cable (10P/2.0mm-10P/2.0mm)
  - 1 x Serial ATA cable (7-pin, standard)
  - 1 x Wire SATA power cable (15-pin,2P/2.0mm)
  - 1 x Flat cable 9P(M)-PHD 10P/2.0mm)
- 3M foam (VHB-4622 10mm\*20mm\*1.1mm)



---

If any of the above items is damaged or missing, contact your retailer.

---



### 1.3 Document Amendment History

Revision	Date	By	Comment
1 <sup>st</sup>	September 2019		Initial Release
2 <sup>nd</sup>	October 2019		Update System Specifications
3 <sup>rd</sup>	March 2020		Update System Specifications

### 1.4 Manual Objectives

We have tried to include as much information as possible but we have not duplicated information that is provided in the standard IBM Technical References, unless it proved to be necessary to aid in the understanding of this board.

We strongly recommend that you study this manual carefully before attempting to set up ECM-KBLU or change the standard configurations. Whilst all the necessary information is available in this manual we would recommend that unless you are confident, you contact your supplier for guidance.

Please be aware that it is possible to create configurations within the CMOS RAM that make booting impossible. If this should happen, clear the CMOS settings, (see the description of the Jumper Settings for details).

If you have any suggestions or find any errors regarding this manual and want to inform us of these, please contact our Customer Service department with the relevant details.

## 1.5 System Specifications

System	
<b>CPU</b>	Intel® Core™ i7-7600U Processor (4M Cache, up to 3.90 GHz) Intel® Core™ i5-7300U Processor (3M Cache, up to 3.50 GHz) Intel® Core™ i3-7100U Processor (3M Cache, 2.40 GHz) Intel® Celeron® Processor 3965U (2M Cache, 2.20 GHz)
<b>BIOS</b>	AMI uEFI BIOS, 128 Mbit SPI Flash ROM iAMT supported
<b>I/O Chip</b>	EC(IT8528E)
<b>System Memory</b>	1 x 260-Pin DDR4 2133MTs SO-DIMM (support non-ECC only)
<b>SSD</b>	1 x M.2( 2242/3042) (B key support SATA or PCIE, USB3 only& USB2) 1 x mSATA, supported from MiniPCle
<b>Watchdog Timer</b>	H/W Reset, 1sec. - 65535sec.
<b>H/W Status Monitor</b>	Monitoring CPU Temperature, Voltage and FAN Status with Auto Throttling Control
<b>Expansion</b>	1 x Full-Size Mini PCI Express Mini Card with mSATA supported (half size support with standoff) 1 x M.2 (2242) B-Key with Micro SIM Card connector for 3G/4G
I/O	
<b>MIO</b>	1 x SATA III 1 x DB-9 male connector for COM1(RS-232) 1 x JCOM2 (RS232/422/485 selected by GPIO w/ Auto Flow), 422/485 with 2 x 3 pin header 4 x RS-232 (Pin Header) LPC, SPI
<b>USB</b>	4 x USB3.1 Gen1 5gbps(dual deck USB connector for 2 USB3.0 port), 2 x USB 2.0(Wafer)
<b>GPIO</b>	8-bit GPIO
Display	
<b>Chipset</b>	Intel® Kabylake Processor integrated Graphics
<b>Resolution</b>	HDMI: Max. resolution 4096 x 2160@24Hz LVDS: Max. resolution 1920 x 1200@60Hz LVDS + Dual HDMI Dual-channel 18/24-bit LVDS
<b>Multiple Display</b>	Dual display
<b>HDMI</b>	HDMI 1.4b
<b>LCD Interface</b>	Dual channel 18/24-bit LVDS (via 7511B)

## ECM-KBLU User's Manual

<b>Audio</b>	
<b>AC97 Codec</b>	Realtek ALC892 HD codec Supports 5.1-CH Audio (Co-lay with ALC888S-VD2-GR)
<b>Audio Amp</b>	Line in ,Line-Out, Mic in
<b>Ethernet</b>	
<b>LAN Chip</b>	1 x Intel I211AT GbE controller (Co-lay I210AT) 1 x Intel I219LM Gigabit Ethernet PHY
<b>Ethernet Interface</b>	10/100/1000 Base-Tx compatible
<b>Internal I/O Connectors</b>	
<b>Fan</b>	2 x Fan 4P-Wafer
<b>Buzzer</b>	Buzzer with wafer header
<b>CMOS Battery</b>	Wire CR2032
<b>Power On</b>	2 x 5-pin header
<b>Audio</b>	2 x 6-pin header
<b>COM</b>	4 x RS232 pin header 1 x (2 x 3 )pin header for RS422/485(COM2)
<b>Rear I/O Connectors</b>	
<b>USB</b>	4 x USB3.0
<b>LAN</b>	2 x Ethernet
<b>HDMI</b>	2 x HDMI
<b>COM</b>	1 X D-sub 9 pin (RS232)
<b>LED</b>	Stack LED for PWR and HDD LED
<b>Mechanical &amp; Environmental</b>	
<b>Power Requirement</b>	+12V ~ +26V
<b>ACPI</b>	Single power ATX Support S0, S3, S4, S5 ACPI 5.0 Compliant
<b>Power Type</b>	AT / ATX
<b>Operating Temp.</b>	0°C ~ 60°C
<b>Storage Temp.</b>	-40°C ~ 75°C
<b>Operating Humidity</b>	40°C / RH95% relative humidity, non-condensing
<b>Size (L x W)</b>	5.7" x 4" (146mm x 101mm)
<b>Weight</b>	0.44 lbs (0.2 Kg)
<b>OS Support</b>	Win10/Linux



**Note:** Specifications are subject to change without notice.

## 1.6 Architecture Overview—Block Diagram

The following block diagram shows the architecture and main components of ECM-KBLU.

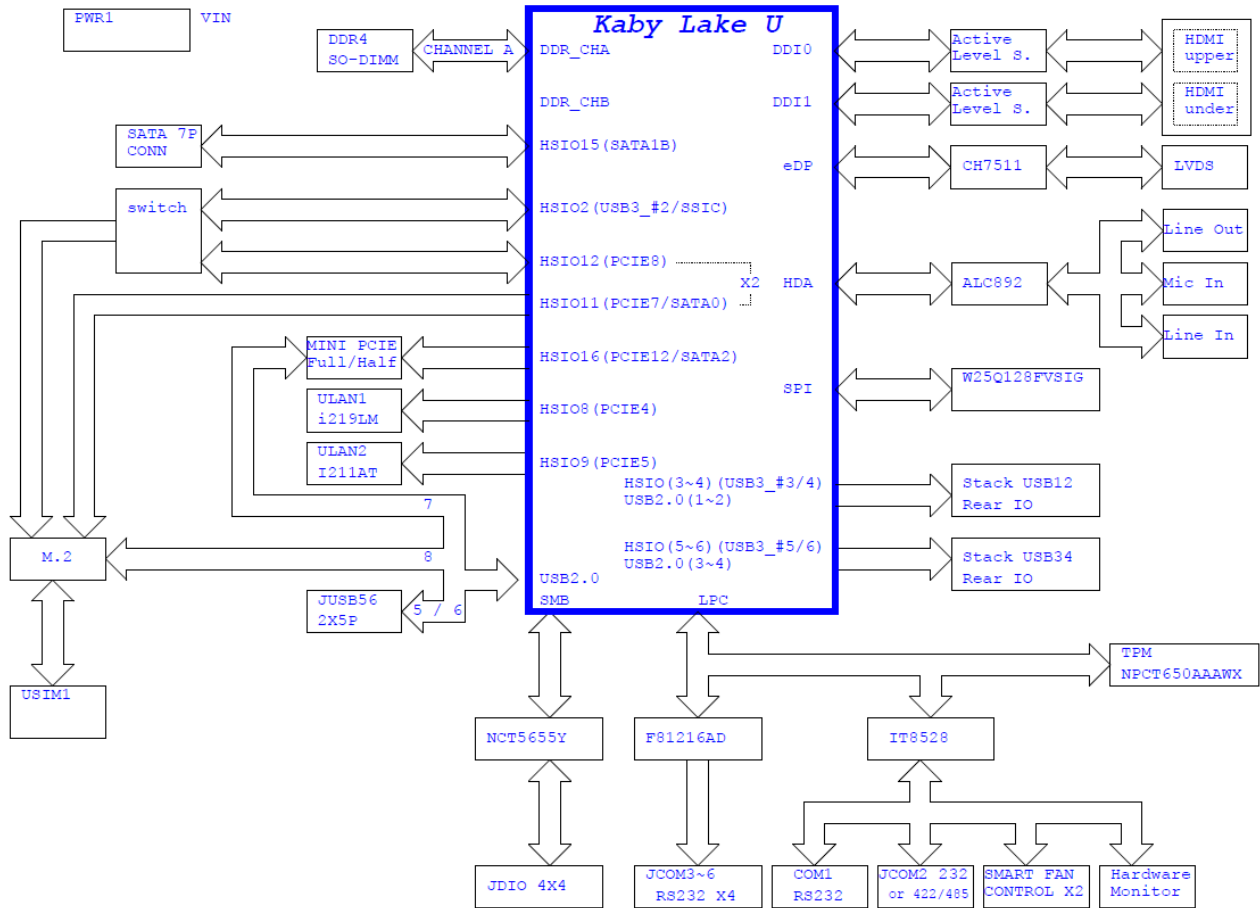

# 2. Hardware Configuration

---

## 2.1 Product Overview

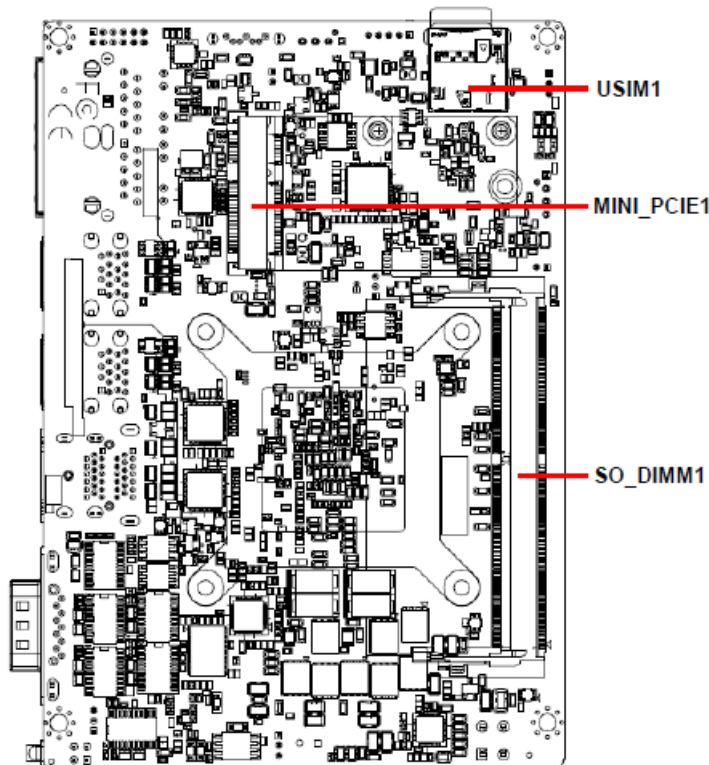
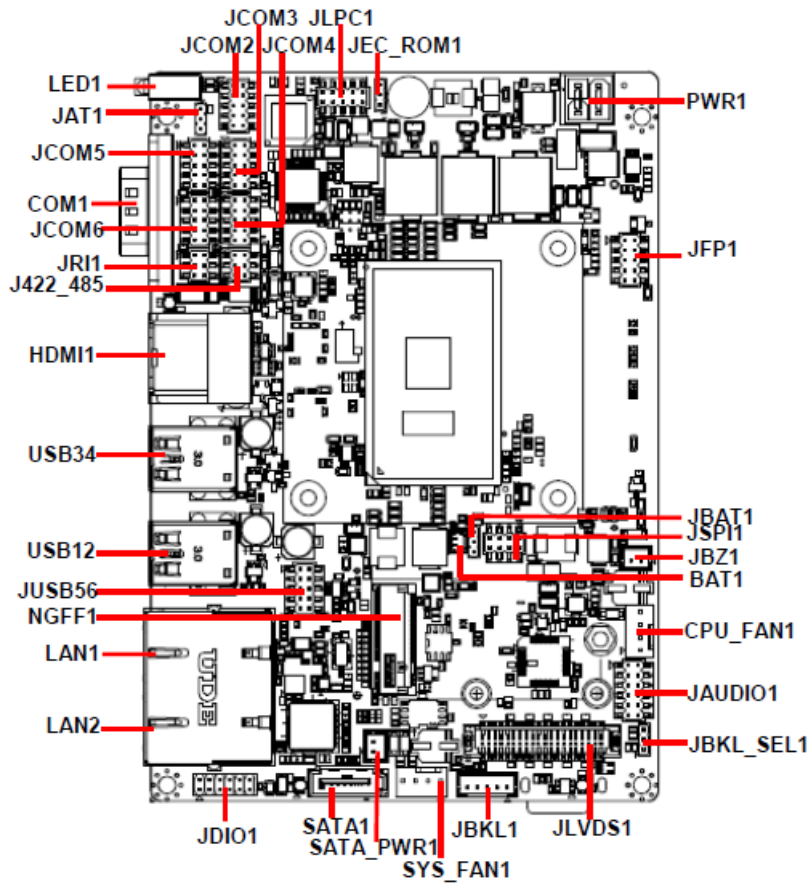



## 2.2 Jumper and Connector List

You can configure your board to match the needs of your application by setting jumpers. A jumper is the simplest kind of electric switch.

It consists of two metal pins and a small metal clip (often protected by a plastic cover) that slides over the pins to connect them. To “close” a jumper you connect the pins with the clip. To “open” a jumper you remove the clip. Sometimes a jumper will have three pins, labeled 1, 2, and 3. In this case, you would connect either two pins.

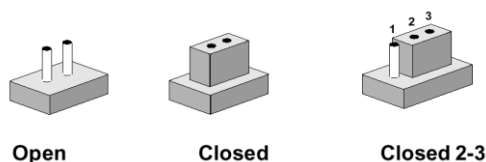

The jumper settings are schematically depicted in this manual as follows:



A pair of needle-nose pliers may be helpful when working with jumpers.

Connectors on the board are linked to external devices such as hard disk drives, a keyboard, or floppy drives. In addition, the board has a number of jumpers that allow you to configure your system to suit your application.

If you have any doubts about the best hardware configuration for your application, contact your local distributor or sales representative before you make any changes.

The following tables list the function of each of the board's jumpers and connectors.

### Jumpers

Label	Function	Note
JRI1	Serial port 1 pin9 signal select	3 x 2 header, pitch 2.00mm
JAT1	AT/ATX Input power select	3 x 1 header, pitch 2.00mm
JBKL_SEL1	LCD backlight brightness adjustment	3 x 1 header, pitch 2.00mm
JBAT1	Clear CMOS	3 x 1 header, pitch 2.00mm

### Connectors

Label	Function	Note
JBKL1	LCD inverter connector	5 x 1 wafer, pitch 2.00mm Matching Connector: JST PHR-5
CPU_FAN1	CPU fan connector	4 x 1 wafer, pitch 2.54mm
SYS_FAN1	System fan connector	4 x 1 wafer, pitch 2.54mm
COM1	Serial Port 1 connector	D-sub 9 pin, male

## ECM-KBLU User's Manual

<b>JCOM2/3/4/5/6</b>	Serial Port 2/3/4/5/6 connector	5 x 2 header, pitch 2.00mm
<b>J422_485</b>	Serial port 2 in RS-422/485 mode	3 x 2 header, pitch 2.00mm
<b>JDIO1</b>	General purpose I/O connector	6 x 2 wafer, pitch 2.00mm
<b>NGFF1</b>	M.2 KEY-B 2242 connector	
<b>LED1</b>	HDD/Power LED indicator	
<b>JLVDS1</b>	LVDS connector	DIN 40-pin wafer, pitch 1.25mm Matching Connector: Hirose DF13-40DS-1.25C
<b>JFP1</b>	Front Panel connector	5 x 2 header, pitch 2.00mm
<b>USB12/34</b>	4 x USB3.0 connector	
<b>JUSB56</b>	USB2.0 connector	5 x 2 header, pitch 2.00mm
<b>JBZ1</b>	PC Buzzer connector	2 x 1 wafer, pitch 2.00mm
<b>JAUDIO1</b>	Audio connector	6 x 2 header, pitch 2.00mm
<b>LAN1/2</b>	RJ-45 Ethernet 1/2	
<b>BAT1</b>	Battery connector	2 x 1 wafer, pitch 1.25mm
<b>JLPC1</b>	LPC connector	5 x 2 header, pitch 2.00mm
<b>PWR1</b>	Power connector	2 x 2 wafer, pitch 4.20mm
<b>JSPI1</b>	SPI connector	4 x 2 header, pitch 2.00mm
<b>JEC_ROM1</b>	EC Debug connector	3 x 1 header, pitch 2.00mm
<b>SATA_PWR1</b>	SATA Power connector	2 x 1 wafer, pitch 2.00mm
<b>SATA1</b>	Serial ATA connector	
<b>HDMI1</b>	HDMI connector	
<b>SO_DIMM1</b>	DDR4 SODIMM socket	
<b>MINI_PCIE1</b>	Mini-PCIe_connector	
<b>USIM1</b>	SIM card slot	

## 2.3 Setting Jumpers & Connectors

### 2.3.1 Serial port 1 pin9 signal select (JRI1)

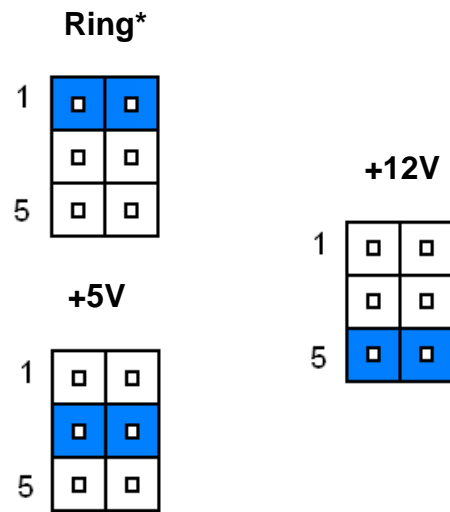
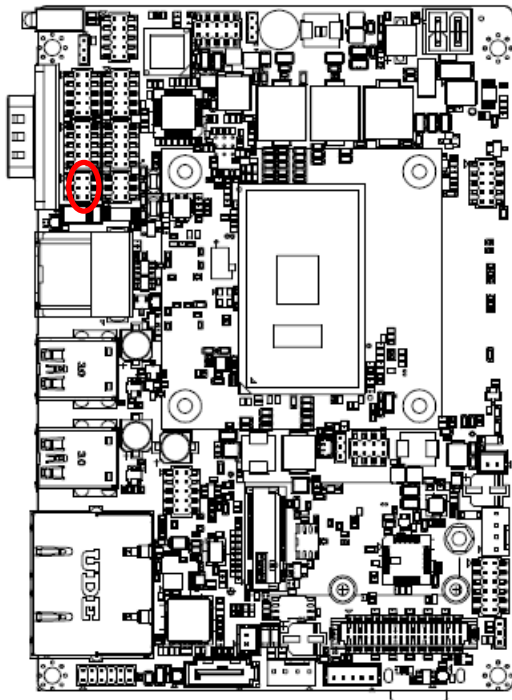

\* Default

### 2.3.2 Clear CMOS (JBAT1)

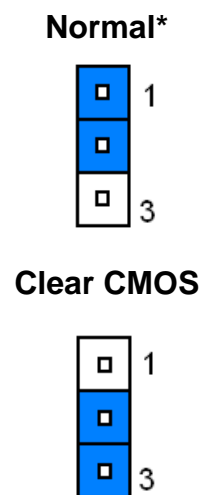
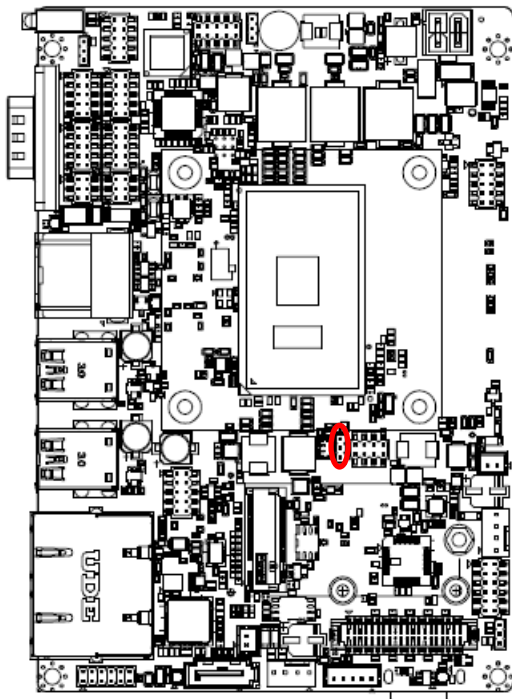

\* Default

2.3.3 LCD backlight brightness adjustment (JBKL\_SEL1)

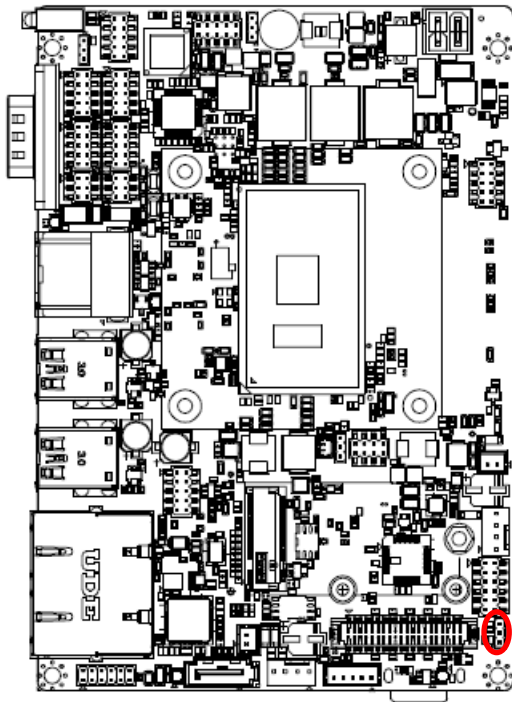

PWM Mode\*

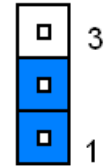

DC Mode

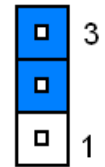

\* Default

2.3.4 AT/ATX Input power select (JAT1)

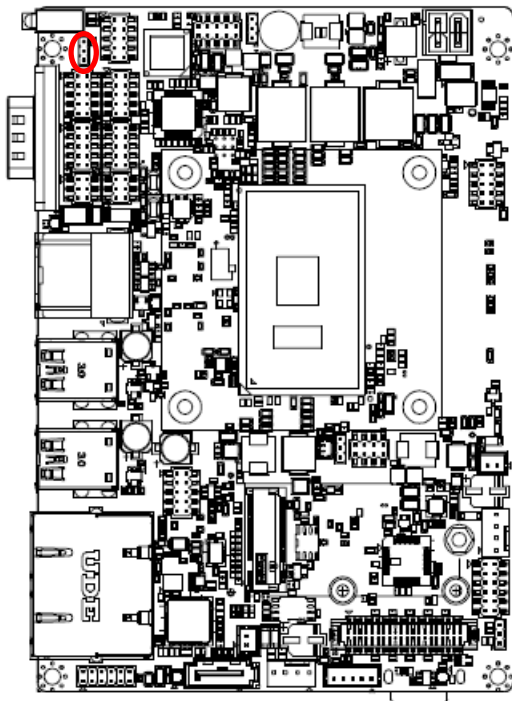

AT\*

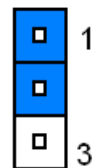

ATX

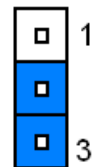

\* Default

### 2.3.5 LCD inverter connector (JBKL1)

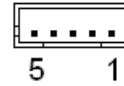
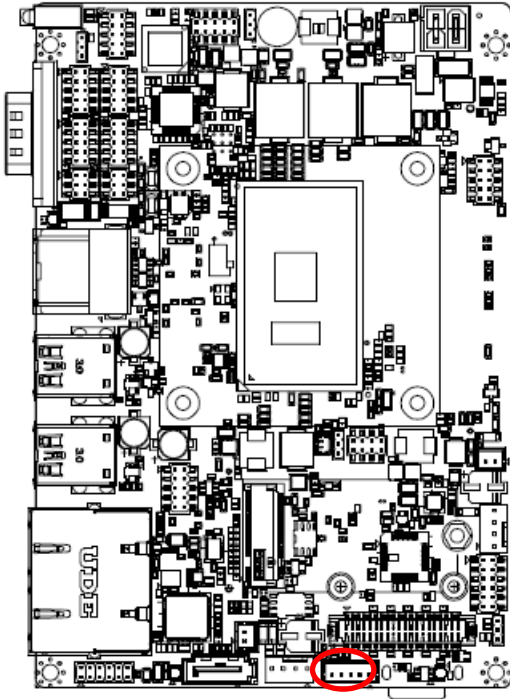

Signal	PIN
+12V	1
GND	2
BKLEN	3
VBRIGHT	4
+5V	5

### 2.3.6 CPU fan connector (CPU\_FAN1)

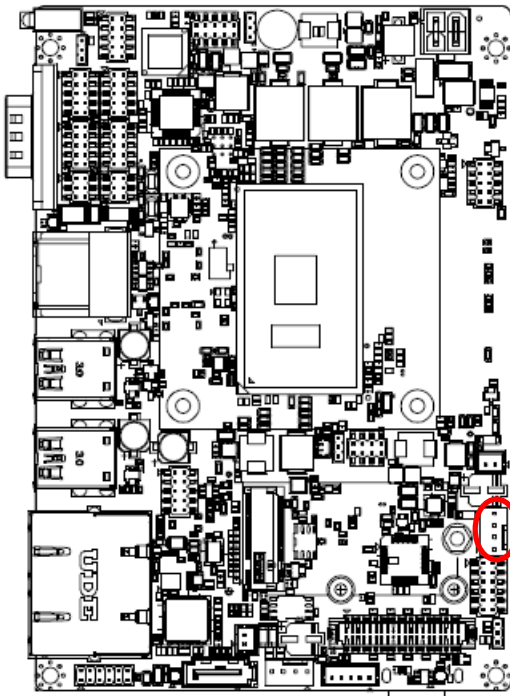

Signal	PIN
PWM_FAN0	4
EC_TACH0	3
+12V	2
GND	1

2.3.7 System fan connector (SYS\_FAN1)

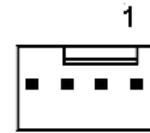
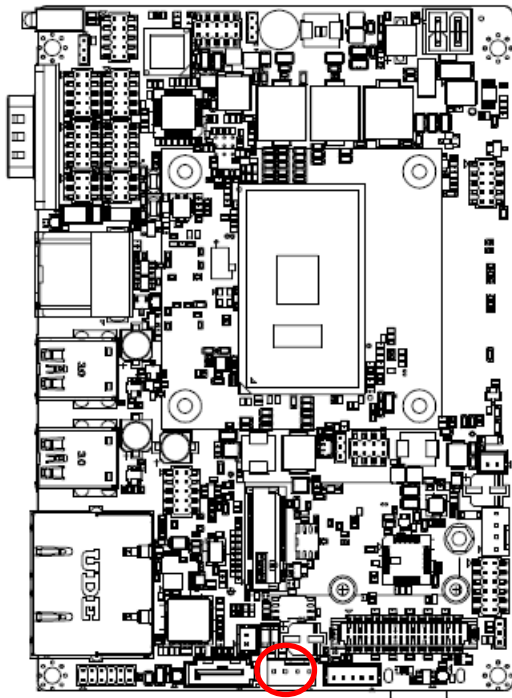

Signal	PIN
GND	1
+12V	2
EC_TACH1	3
PWM_FAN1	4

2.3.8 Serial port 2/3/4/5/6 connector (JCOM2/3/4/5/6)

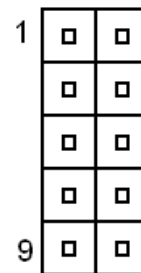
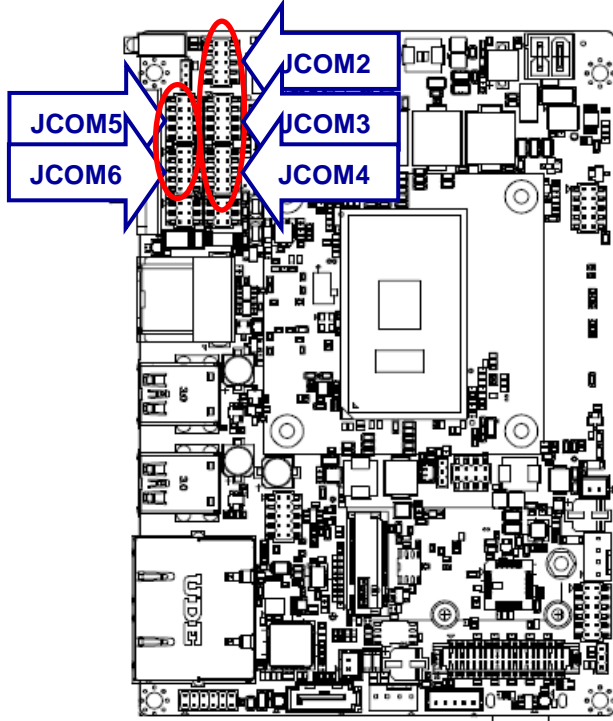

Signal	PIN	PIN	Signal
COM_DCD#	1	2	COM_RXD
COM_TXD	3	4	COM_DTR#
GND	5	6	COM_DSR#
COM_RTS#	7	8	COM_CTS#
COM_RI#	9	10	NC

### 2.3.9 Serial port 2 in RS-422/485 mode (J422\_485)

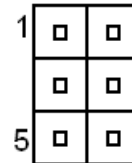
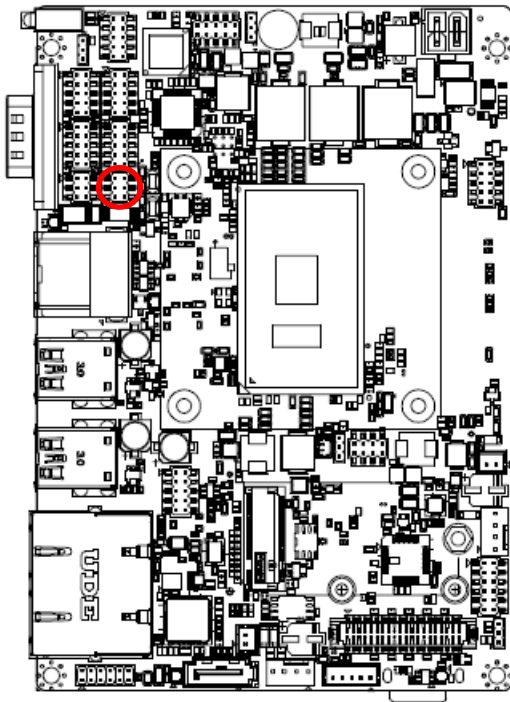

Signal	PIN	PIN	Signal
485-422_TXDN	1	2	485-422_TXDP
422_RXDP	3	4	422_RXDN
+5V	5	6	GND

### 2.3.10 General purpose I/O connector (JDIO1)

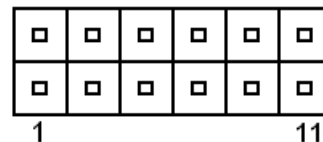
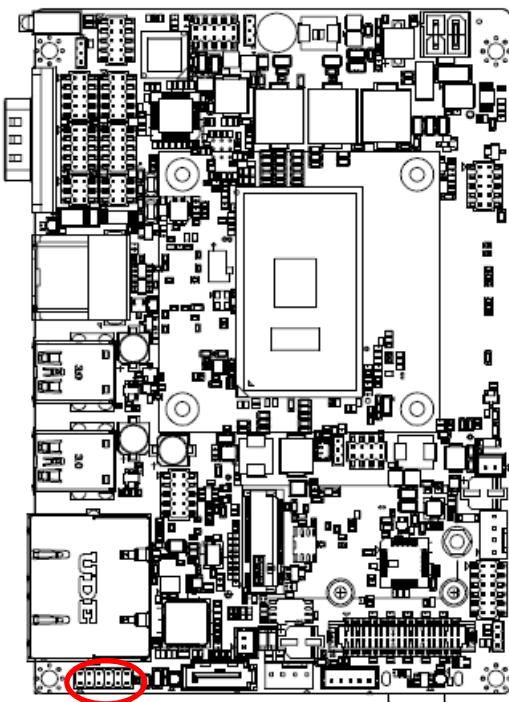

Signal	PIN	PIN	Signal
DIO_GP20	1	2	DIO_GP10
DIO_GP21	3	4	DIO_GP11
DIO_GP22	5	6	DIO_GP12
DIO_GP23	7	8	DIO_GP13
SMB_SCL_S0	9	10	SMB_SDA_S0
GND	11	12	+5V



2.3.11 SATA Power connector (SATA\_PWR1)

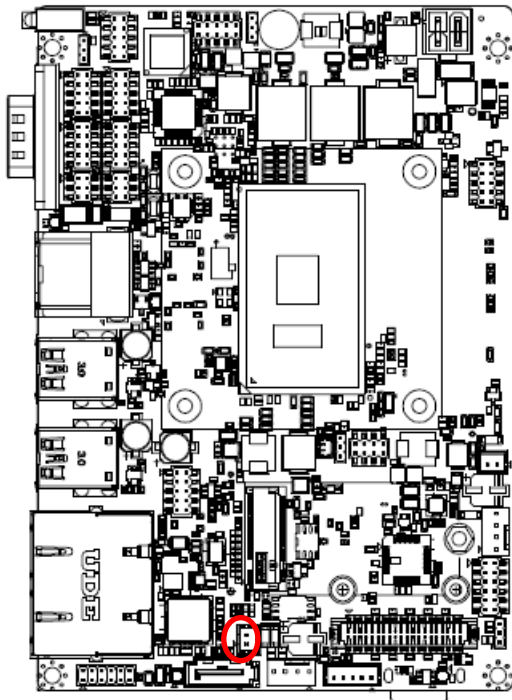

Signal	PIN
+5V	2
GND	1

2.3.12 Power connector (PWR1)

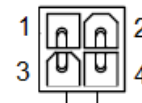
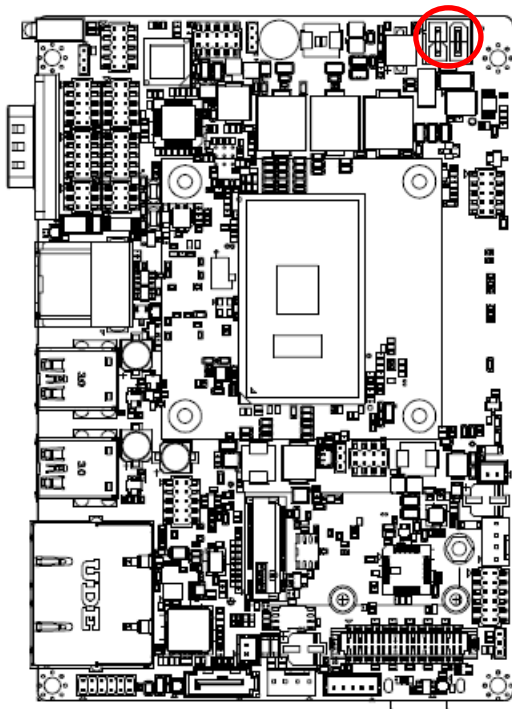

Signal	PIN	PIN	Signal
GND	1	2	GND
+26V	3	4	+26V



2.3.13 LVDS connector (JLVDS1)

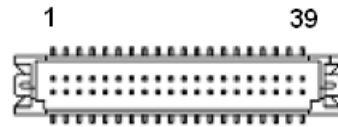
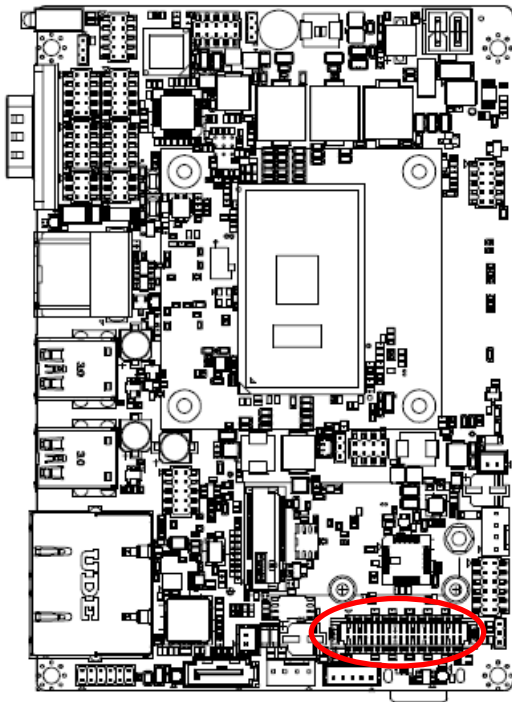

Signal	PIN	PIN	Signal
+3.3V	1	2	+5V
+3.3V	3	4	+5V
NC	5	6	NC
GND	7	8	GND
LVDS_DATA1_P	9	10	LVDS_DATA0_P
LVDS_DATA1_N	11	12	LVDS_DATA0_N
GND	13	14	GND
LVDS_DATA3_P	15	16	LVDS_DATA2_P
LVDS_DATA3_N	17	18	LVDS_DATA2_N
GND	19	20	GND
LVDS_DATA5_P	21	22	LVDS_DATA4_P
LVDS_DATA5_N	23	24	LVDS_DATA4_N
GND	25	26	GND
LVDS_DATA7_P	27	28	LVDS_DATA6_P
LVDS_DATA7_N	29	30	LVDS_DATA6_N
GND	31	32	GND
LVDS_CLK2_P	33	34	LVDS_CLK1_P
LVDS_CLK2_N	35	36	LVDS_CLK1_N
GND	37	38	GND
+12V	39	40	+12V

2.3.14 USB2.0 connector (JUSB56)

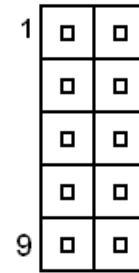
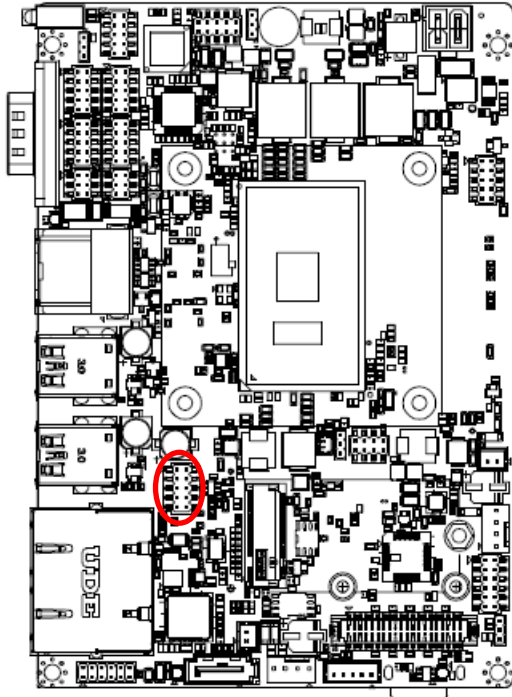

Signal	PIN	PIN	Signal
+5VSB	1	2	GND
USB_R_DN5	3	4	GND
USB_R_DP5	5	6	USB_R_DP6
GND	7	8	USB_R_DN6
GND	9	10	+5VSB

2.3.15 SPI connector (JSPI1)

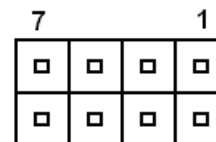
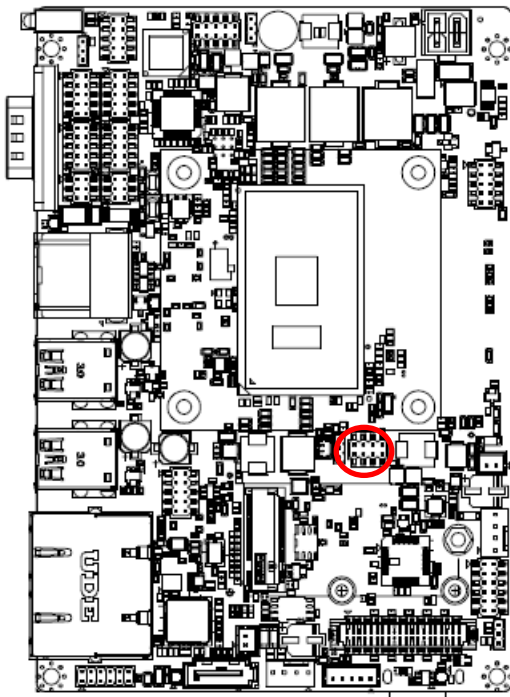

Signal	PIN	PIN	Signal
+3.3VSB	1	2	GND
SPI_CS0#	3	4	SPI_CLK
SPI_MISO	5	6	SPI_MOSI
BIOS_HOLD#	7	8	BIOS_WP#

### 2.3.16 EC Debug connector (JEC\_ROM1)

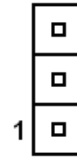
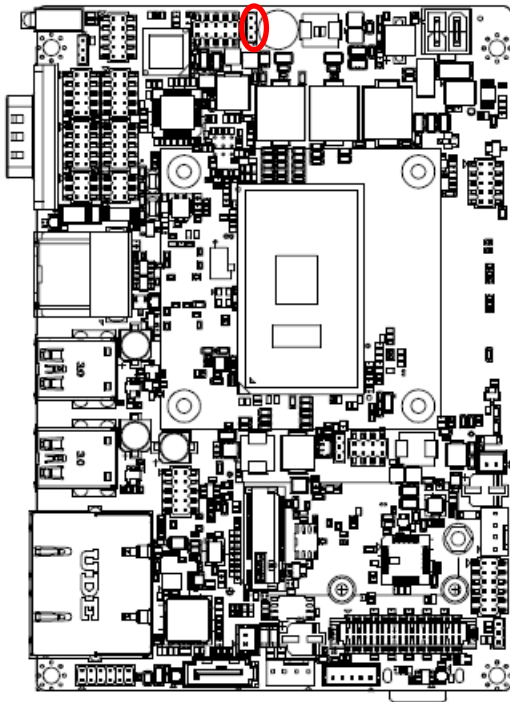

Signal	PIN
GND	3
EC_SMDAT_DEBUG	2
EC_SMCLK_DEBUG	1

### 2.3.17 Battery connector (BAT1)

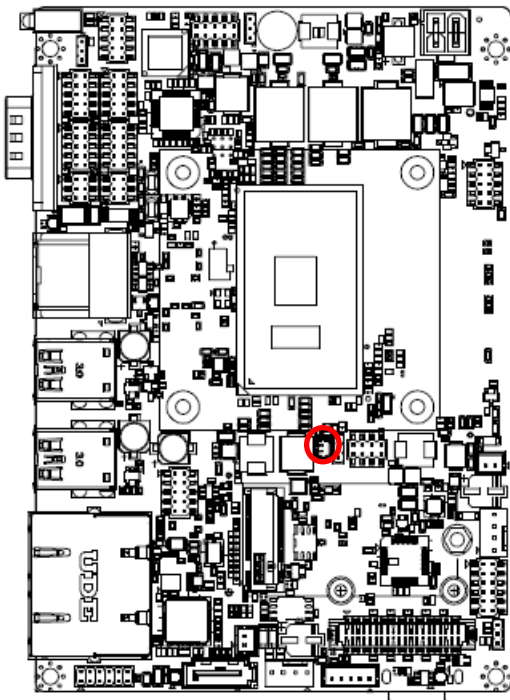

Signal	PIN
+RTCBAT	1
GND	2

2.3.18 LPC connector (JLPC1)

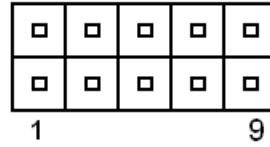
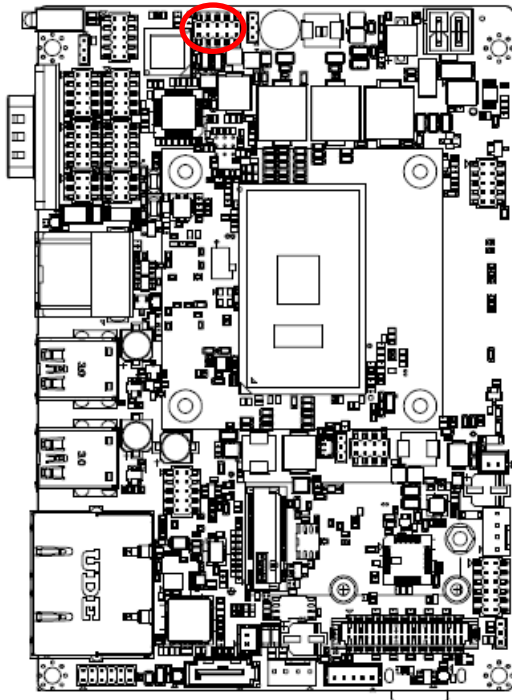

Signal	PIN	PIN	Signal
LPC_AD0	1	2	+3.3V
LPC_AD1	3	4	RST_TPM#
LPC_AD2	5	6	LPC_LFRAME#
LPC_AD3	7	8	CLK2_LPC_DEBUG
LPC_SERIRQ	9	10	GND

2.3.19 Front Panel connector (JFP1)

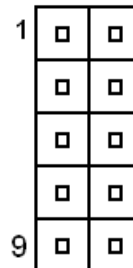
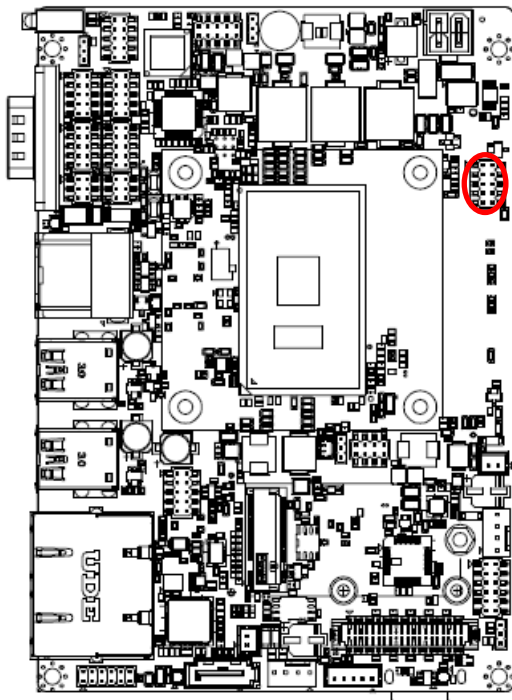

Signal	PIN	PIN	Signal
PWRBTN_TO_EC#	1	2	GND
PM_SYSRST#	3	4	GND
FP_PWR_LED+	5	6	PWR_LED#
HDD_LED#	7	8	+5V
CASE_OPEN#	9	10	GND

2.3.20 PC Buzzer connector (JBZ1)

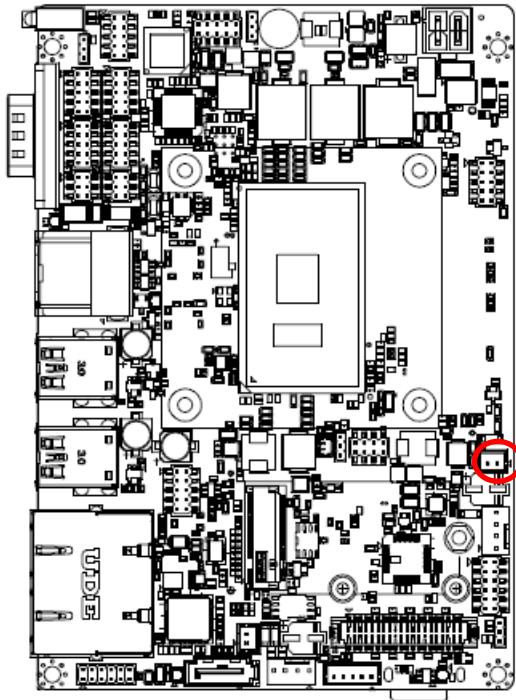

Signal	PIN
SOC_SPKR_R	1
+5V	2

2.3.21 Audio connector (JAUDIO1)

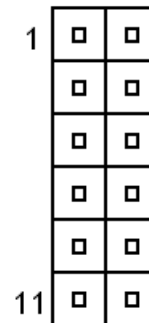
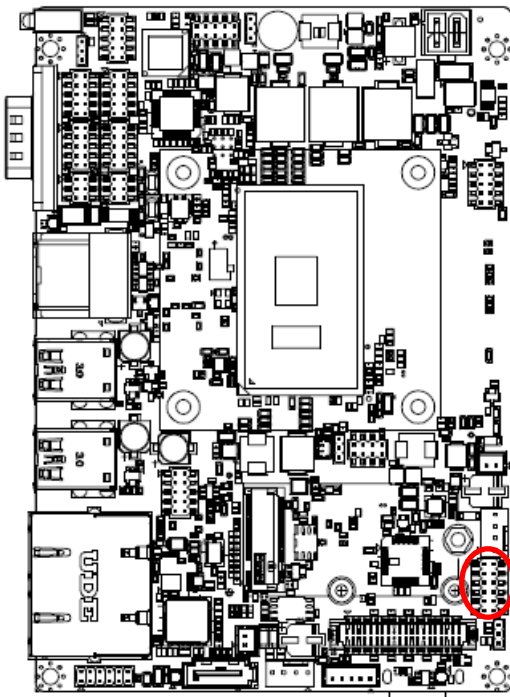

Signal	PIN	PIN	Signal
FRONT-R-OUT	1	2	FRONT-L-OUT
HD_AGND	3	4	HD_AGND
LINE1-R-IN	5	6	LINE1-L-IN
MIC1-R-IN	7	8	MIC1-L-IN
FRONT-JD	9	10	LINE1-JD
MIC1-JD	11	12	HD_AGND

2.3.21.1 Signal Description – Audio connector (JAUDIO1)

Signal	Signal Description
LINE1-JD	AUDIO IN (LINE_RIN/LIN)sense pin
FRONT-JD	AUDIO Out(ROUT/LOUT) sense pin
MIC1-JD	MIC IN (MIC_RIN/LIN) sense pin

## 2.4 AUX-032 User's Guide

### 2.4.1 Jumper and Connector Layout

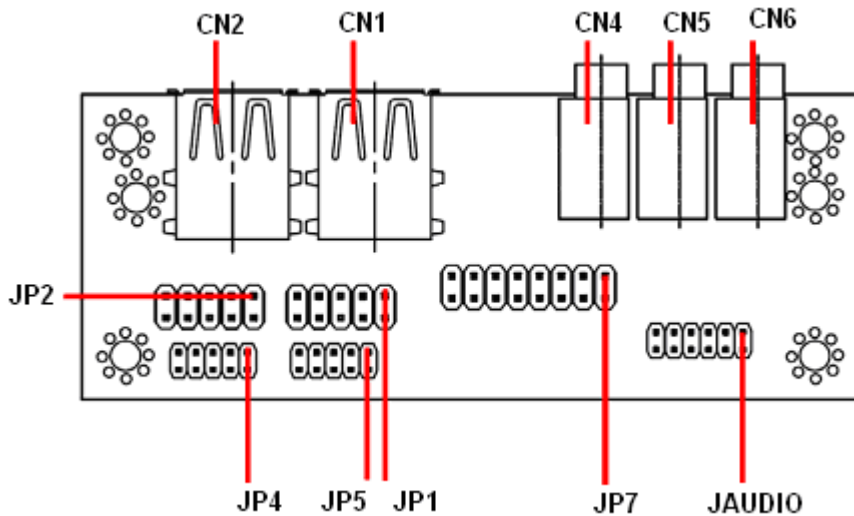

### 2.4.2 Jumper and Connector List

#### Connectors

Label	Function	Note
<b>CN1/2</b>	USB connector	
<b>CN4</b>	Line out connector	Phone Jack
<b>CN5</b>	Line in connector	Phone Jack
<b>CN6</b>	Mic in connector	Phone Jack
<b>JAUDIO</b>	Audio connector	6 x 2 header, pitch 2.0mm
<b>JP1</b>	2.54mm USB connector	5 x 2 header, pitch 2.54mm
<b>JP2</b>	2.54mm USB connector	5 x 2 header, pitch 2.54mm
<b>JP4</b>	2.0mm USB connector	5 x 2 header, pitch 2.0mm
<b>JP5</b>	2.0mm USB connector	5 x 2 header, pitch 2.0mm
<b>JP7</b>	TV / Audio connector	8 x 2 header, pitch 2.54mm

### 2.4.3 Setting Jumper and Connector

#### Audio Connector (JAUDIO)

Signal	PIN	PIN	Signal
OUTR	1	2	OUTL
GND	3	4	GND
INR1	5	6	INL1
MICIN1	7	8	AREF
FRONT-JD1	9	10	LINE1-JD1
MIC1-JD1	11	12	GND

#### 2.54mm USB Connector (JP1)

Signal	PIN	PIN	Signal
+5V	1	2	GND
D1-	3	4	GND
D1+	5	6	D2+
GND	7	8	D2-
GND	9	10	+5V



**Note:** Wrong USB cable configuration with your USB devices might damage your USB devices.

#### 2.54mm USB Connector (JP2)

Signal	PIN	PIN	Signal
+5V	1	2	GND
D3-	3	4	GND
D3+	5	6	D4+
GND	7	8	D4-
GND	9	10	+5V

#### TV / Audio Connector (JP7)

Signal	PIN	PIN	Signal
Mic In	1	2	Mic Bais
GND	3	4	GND
Line out L	5	6	Line out R
SPK L	7	8	SPK R
Line in L	9	10	Line in R
GND	11	12	NC
TVGND	13	14	NC
TVGND	15	16	COMP

#### 2.0mm USB Connector (JP4)

Signal	PIN	PIN	Signal
+5V	1	2	GND
D3-	3	4	GND
D3+	5	6	D4+
GND	7	8	D4-
GND	9	10	+5V

#### 2.0mm USB Connector (JP5)

Signal	PIN	PIN	Signal
+5V	1	2	GND
D1-	3	4	GND
D1+	5	6	D2+
GND	7	8	D2-
GND	9	10	+5V

# 3. BIOS Setup

---



### 3.1 Introduction

The BIOS setup program allows users to modify the basic system configuration. In this following chapter will describe how to access the BIOS setup program and the configuration options that may be changed.

### 3.2 Starting Setup

AMI BIOS™ is immediately activated when you first power on the computer. The BIOS reads the system information contained in the NVRAM and begins the process of checking out the system and configuring it. When it finishes, the BIOS will seek an operating system on one of the disks and then launch and turn control over to the operating system.

While the BIOS is in control, the Setup program can be activated in one of two ways:

By pressing <ESC> or <Del> immediately after switching the system on, or

By pressing the <ESC> or <Del> key when the following message appears briefly at the left-top of the screen during the POST (Power On Self Test).

**Press <ESC> or <Del> to enter SETUP**

If the message disappears before you respond and you still wish to enter Setup, restart the system to try again by turning it OFF then ON or pressing the "RESET" button on the system case. You may also restart by simultaneously pressing <Ctrl>, <Alt>, and <Delete> keys.

### 3.3 Using Setup

In general, you use the arrow keys to highlight items, press <Enter> to select, use the PageUp and PageDown keys to change entries, press <F1> for help and press <Esc> to quit. The following table provides more detail about how to navigate in the Setup program using the keyboard.

Button	Description
↑	Move to previous item
↓	Move to next item
←	Move to the item in the left hand
→	Move to the item in the right hand
Esc key	Main Menu -- Quit and not save changes into NVRAM Status Page Setup Menu and Option Page Setup Menu -- Exit current page and return to Main Menu
+ key	Increase the numeric value or make changes
- key	Decrease the numeric value or make changes
F1 key	General help, only for Status Page Setup Menu and Option Page Setup Menu
F2 key	Previous Values
F3 key	Optimized defaults
F4 key	Save & Exit Setup

- **Navigating Through The Menu Bar**

Use the left and right arrow keys to choose the menu you want to be in.



**Note:** Some of the navigation keys differ from one screen to another.

- **To Display a Sub Menu**

Use the arrow keys to move the cursor to the sub menu you want. Then press <Enter>. A “➤” pointer marks all sub menus.

### 3.4 Getting Help

Press F1 to pop up a small help window that describes the appropriate keys to use and the possible selections for the highlighted item. To exit the Help Window press <Esc> or the <Enter> key again.

### 3.5 In Case of Problems

If, after making and saving system changes with Setup, you discover that your computer no longer is able to boot, the AMI BIOS supports an override to the NVRAM settings which resets your system to its defaults.

The best advice is to only alter settings which you thoroughly understand. To this end, we strongly recommend that you avoid making any changes to the chipset defaults. These defaults have been carefully chosen by both BIOS Vendor and your systems manufacturer to provide the absolute maximum performance and reliability. Even a seemingly small change to the chipset setup has the potential for causing you to use the override.

### 3.6 BIOS setup

Once you enter the Aptio Setup Utility, the Main Menu will appear on the screen. The Main Menu allows you to select from several setup functions and exit choices. Use the arrow keys to select among the items and press <Enter> to accept and enter the sub-menu.

#### 3.6.1 Main Menu

This section allows you to record some basic hardware configurations in your computer and set the system clock.

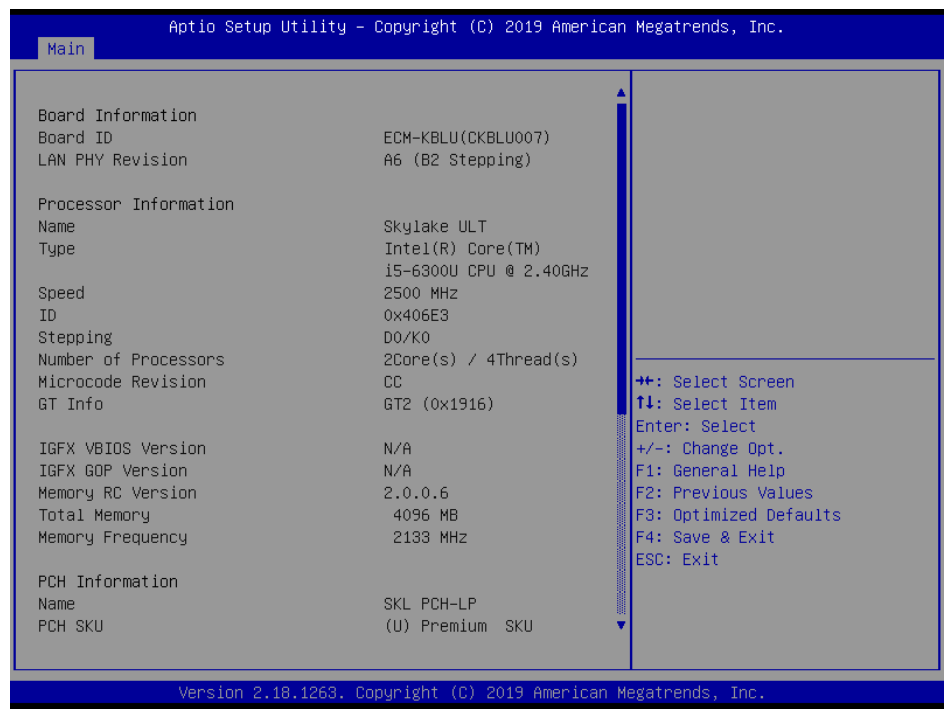
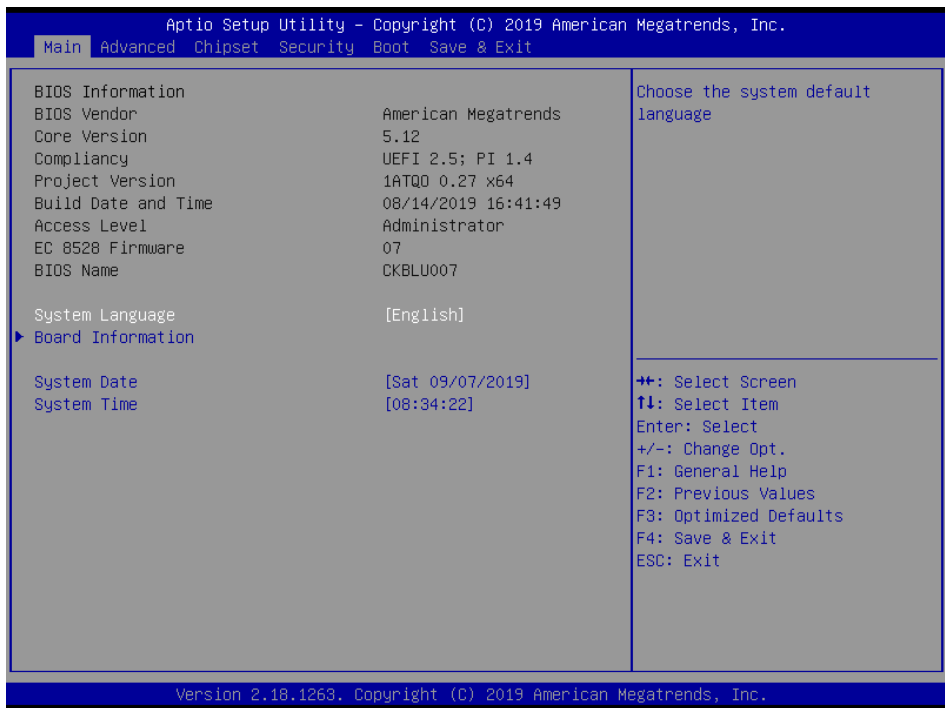

### 3.6.1.1 System Language

This option allows choosing the system default language.

### 3.6.1.2 System Date

Use the system date option to set the system date. Manually enter the day, month and year.

### 3.6.1.3 System Time

Use the system time option to set the system time. Manually enter the hours, minutes and seconds.



**Note:** The BIOS setup screens shown in this chapter are for reference purposes only, and may not exactly match what you see on your screen.

## 3.6.2 Advanced Menu

This section allows you to configure your CPU and other system devices for basic operation through the following sub-menus.

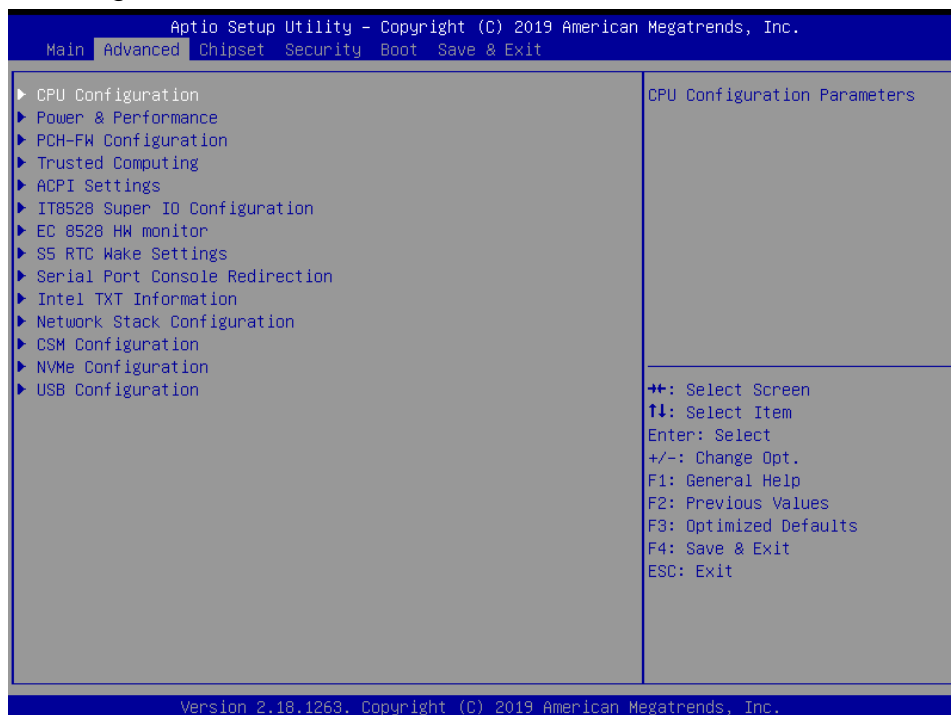

# ECM-KBLU User's Manual

## 3.6.2.1 CPU Configuration

Use the CPU configuration menu to view detailed CPU specification and configure the CPU.



Item	Options	Description
<b>Intel (VMX) Virtualization Technology</b>	Disabled Enabled[Default]	When enabled, a VMM can utilize the additional hardware capabilities provided by Vanderpool Technology.
<b>Active Processor Cores</b>	All[Default] 1 2 3	Number of cores to enable in each processor package.
<b>Hyper-Threading</b>	Disabled Enabled[Default]	Enabled for Windows XP and Linux (OS optimized for Hyper-Threading Technology) and Disabled for other OS (OS not optimized for Hyper-Threading Technology).

### 3.6.2.2 Power & Performance



#### 3.6.2.2.1 CPU – Power Management Control

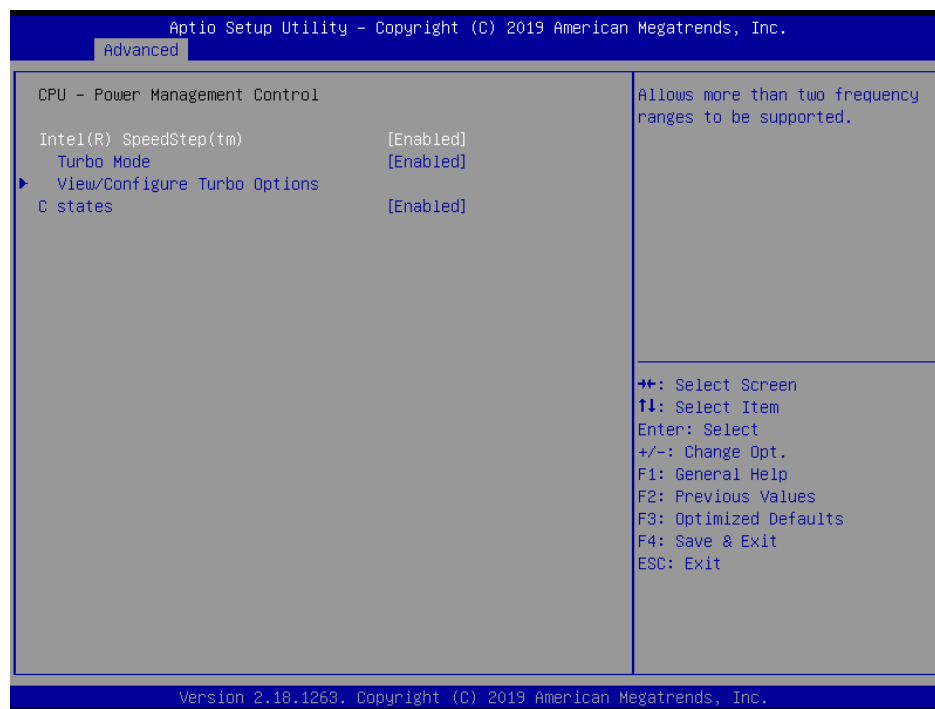

Item	Option	Description
Intel® SpeedStep™	Enabled[Default], Disabled	Allows more than two frequency ranges to be supported.
Turbo Mode	Enabled[Default], Disabled	Enable/Disable processor Turbo Mode (requires EMTTM enabled too). AUTO means enabled, unless max turbo ratio is bigger than 16 – SKL A0 W/A.

<b>C States</b>	Enabled[ <b>Default</b> ], Disabled	Enable/Disable CPU C States.
-----------------	--	------------------------------

### 3.6.2.2.1.1 View/Configure Turbo Options

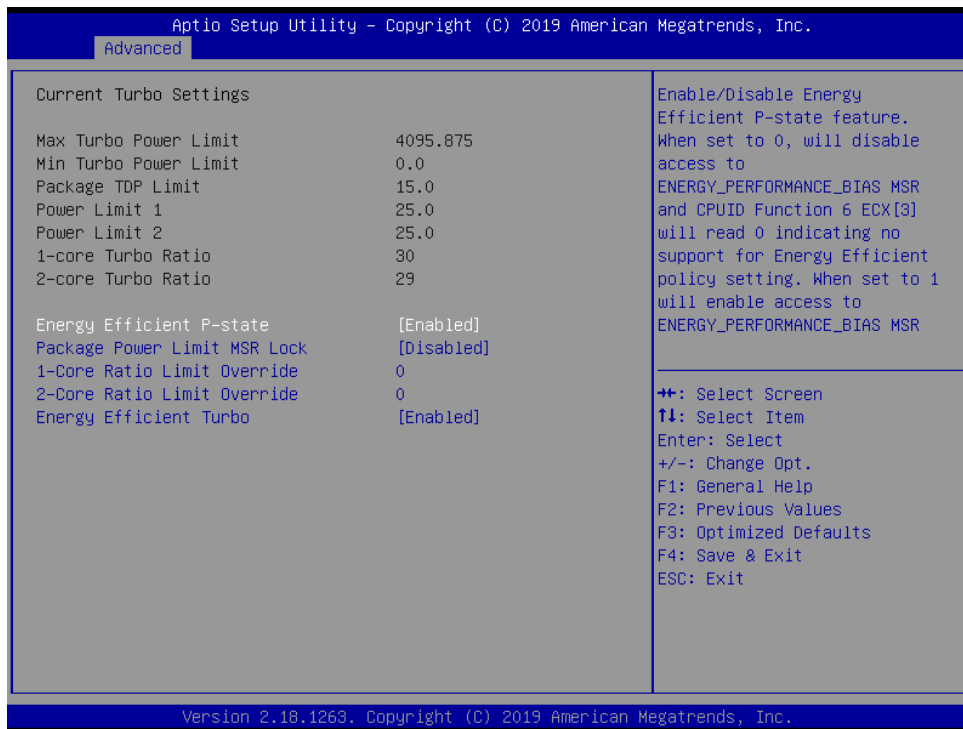

Item	Option	Description
<b>Energy Efficient P-state</b>	Enabled[ <b>Default</b> ], Disabled	Enable/Disable Energy Efficient P-state feature. When set to 0, will disable access to ENERGY_PERFORMANCE_BIAS MSR and CPUID Function 6 ECX[3] will read 0 indicating no support for Energy Efficient policy setting. When set to 1 will enable access to ENERGY_PERFORMANCE_BIAS MSR 1B0h and CPUID Function 6 ECX[3] will read 1 indicating Energy Efficient policy setting is.
<b>Package Power Limit MSR Lock</b>	Disabled[ <b>Default</b> ] Enabled	Enable/Disable locking of Package Power Limit settings. When enabled, PACKAGE_POWER_LIMIT MSR will be locked and a reset will be required to unlock the register.
<b>1-Core Ratio Limit Override</b>	0-83	1-Core Ratio Limit with range 0 to 83. The Minimum range may vary between Processors. This 1-Core Ratio Limit Must be greater than or equal to 2-Core ratio Limit, 3-Core Ratio Limit, 4-Core Ratio Limit.
<b>2-Core Ratio Limit Override</b>	0-83	2-Core Ratio Limit with range 0 to 83. The Minimum range may vary between



		Processors. This 2-Core Ratio Limit Must be Less than or equal to 1-Core Ratio Limit.
<b>Energy Efficient Turbo</b>	Disabled, Enabled[Default]	Enable/Disable Energy Efficient Turbo Feature. This feature will opportunistically lower the turbo frequency to increase efficiency. Recommended only to disable in overclocking situations where turbo frequency must remain constant. Otherwise, leave enabled.

### 3.6.2.2.2 GT – Power Management Control

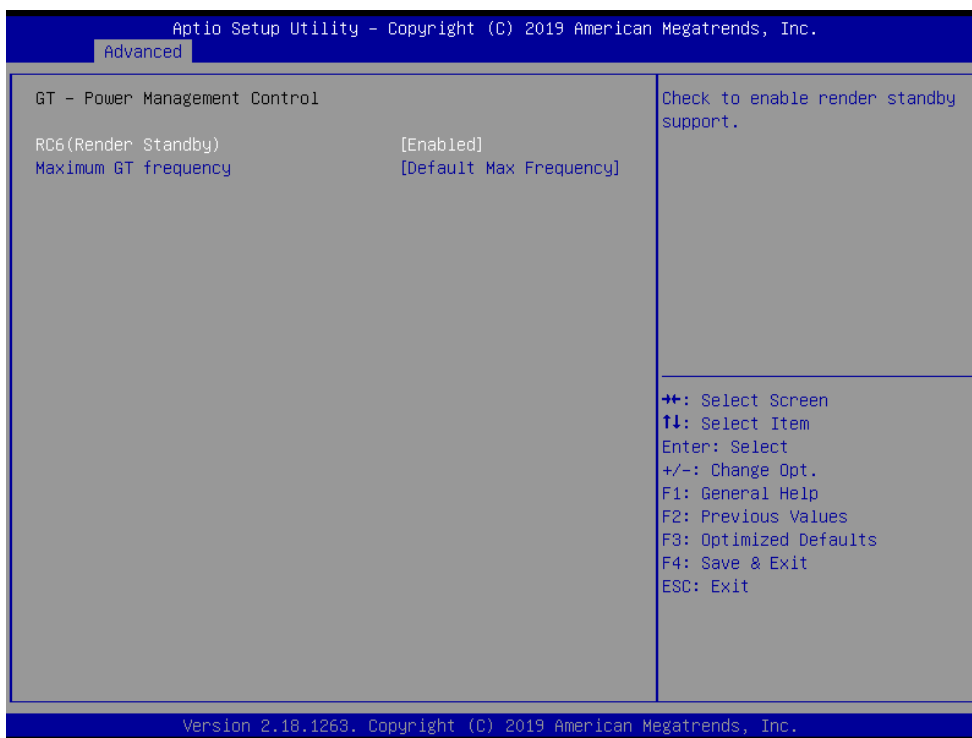

Item	Option	Description
<b>RC6(Render Standby)</b>	Enabled[Default], Disabled	Check to enable render standby support.
<b>Maximum GT frequency</b>	Default Max Frequency[Default] 100Mhz/150Mhz/200Mhz/250Mhz/300Mhz /350Mhz/400Mhz/450Mhz/500Mhz/550Mhz /600Mhz/650Mhz/700Mhz/750Mhz/800Mhz /850Mhz/900Mhz/950Mhz/1000Mhz/1050Mhz /1100Mhz/1150Mhz/1200Mhz	Auto Updated.

3.6.2.3 PCH-FW Configuration

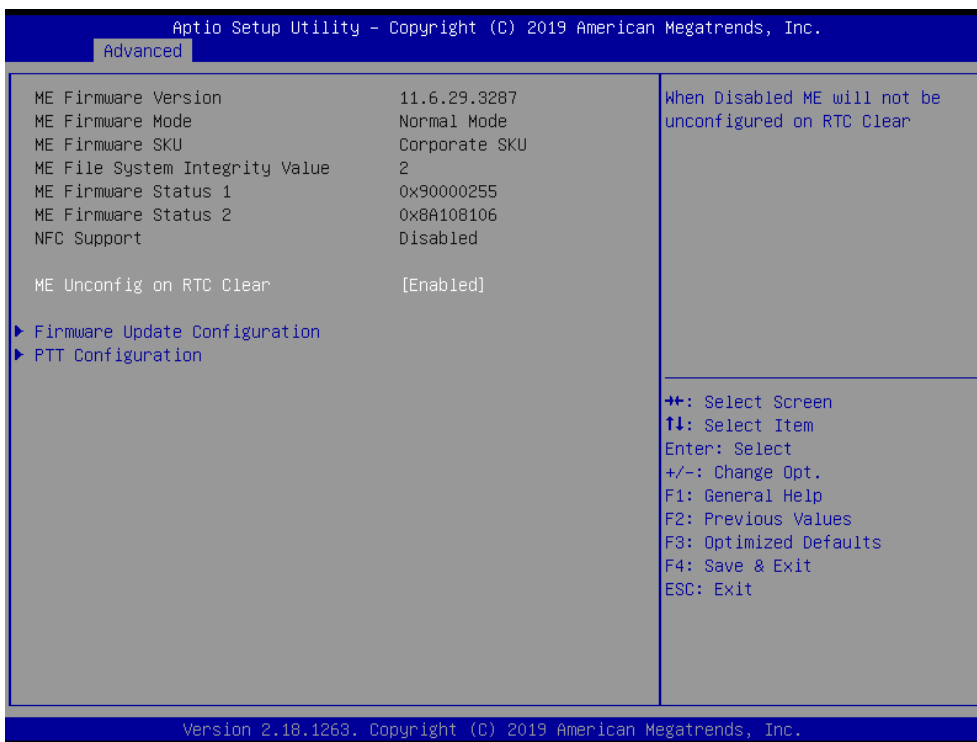

Item	Options	Description
ME Unconfig on RTC Clear	Disabled, Enabled[Default]	When Disabled ME will not be unconfigured on RTC Clear.

3.6.2.3.1 Firmware Update Configuration



Item	Option	Description
<b>ME FW Image Re-Flash</b>	Disabled [ <b>Default</b> ], Enabled	Enable/Disable Me FW Image Re-Flash function.

### 3.6.2.3.2 PTT Configuration

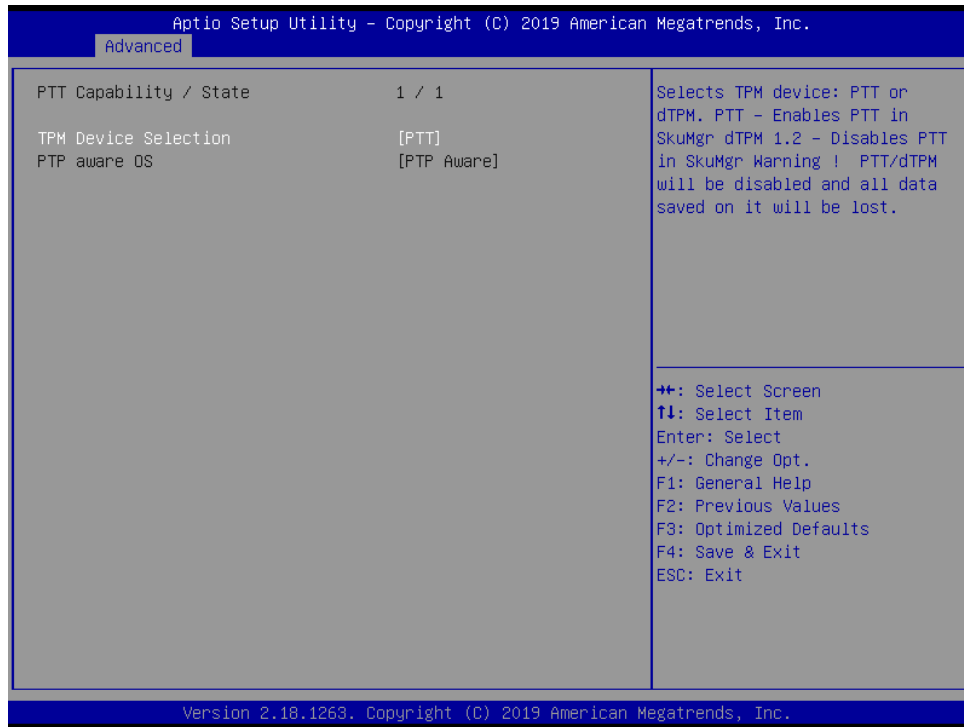

Item	Option	Description
<b>TPM Device Selection</b>	dTPM, PTT[ <b>Default</b> ]	Selects TPM device: PTT or dTPM. PTT – Enables PTT in SkuMgr dTPM 1.2 – Disables PTT in SkuMgr Warning! PTT/dTPM will be disabled and all data saved on it will be lost.

# ECM-KBLU User's Manual

## 3.6.2.4 Trusted Computing

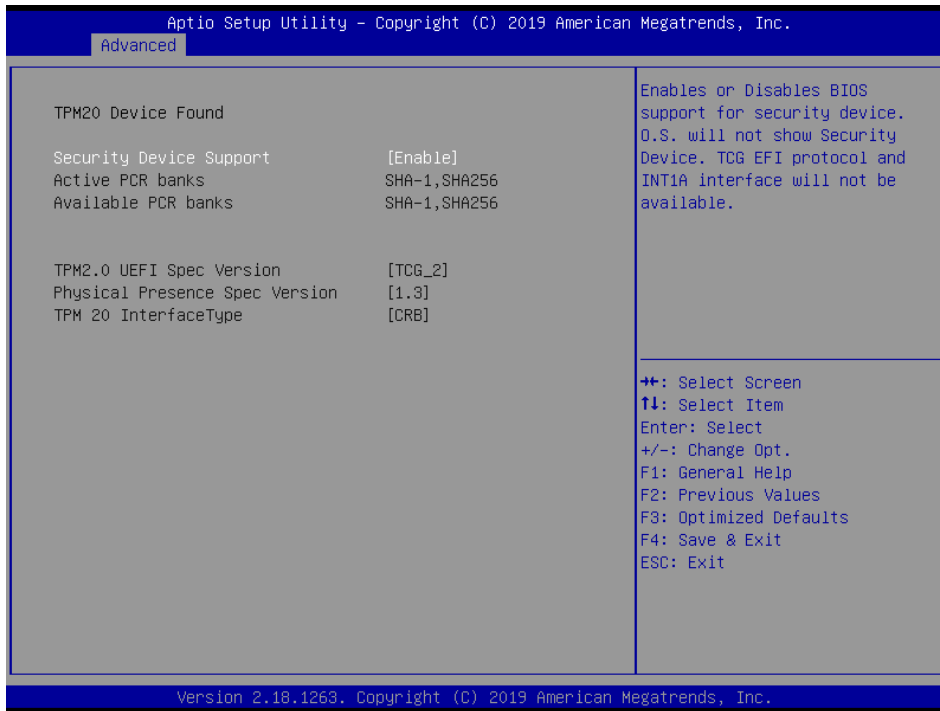

Item	Options	Description
<b>Security Device Support</b>	Disable, Enable[ <b>Default</b> ]	Enables or Disables BIOS support for security device. O.S. will not show Security Device. TCG EFI protocol and INT1A interface will not be available.

## 3.6.2.5 APCI Settings

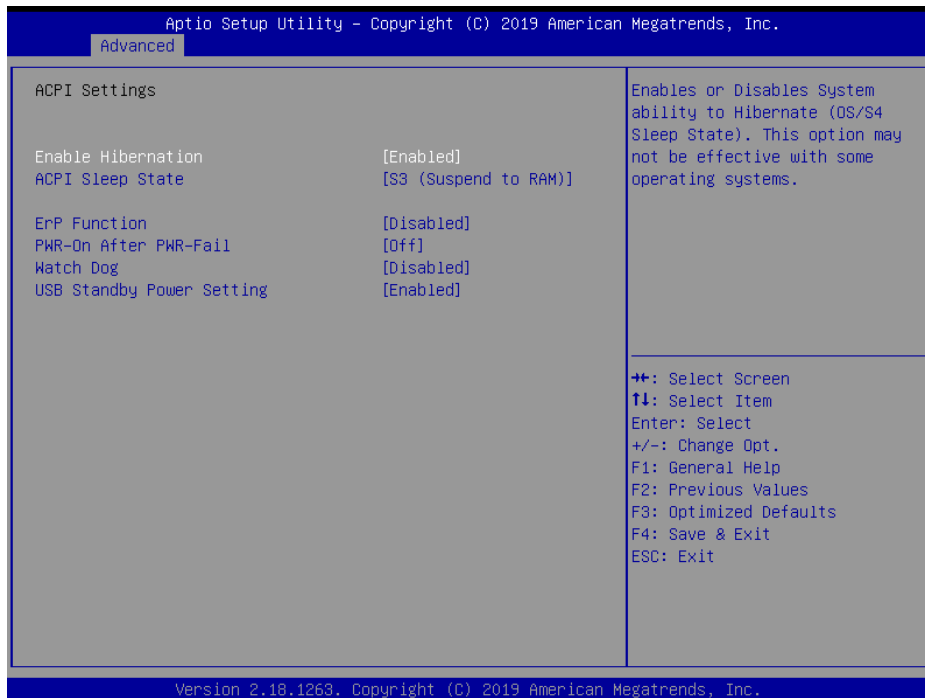

Item	Options	Description
<b>Enable Hibernation</b>	Disabled Enabled[Default],	Enables or Disables System ability to Hibernate (OS/S4 Sleep State). This option may not be effective with some OS.
<b>ACPI Sleep State</b>	Suspend Disabled, S3 (Suspend to RAM)[Default]	Select the highest ACPI sleep state the system will enter when the SUSPEND button is pressed.
<b>ErP Function</b>	Disabled[Default], Enabled	ErP Function (Deep S5).
<b>Pwr-On After PWR-Fail</b>	Off[Default] On Last state	AC loss resume.
<b>Watch Dog</b>	Disabled[Default], 30 sec 40 sec 50 sec 1 min 2 min 10 min 30 min	Select WatchDog.
<b>USB Standby Power Setting</b>	Disabled Enabled[Default],	Enabled/Disabled USB Standby Power during S3/S4/S5.

### 3.6.2.6 IT8528 Super IO Configuration

You can use this item to set up or change the IT8528 Super IO configuration for serial ports. Please refer to 3.6.2.6.1~ 3.6.2.6.6 for more information.

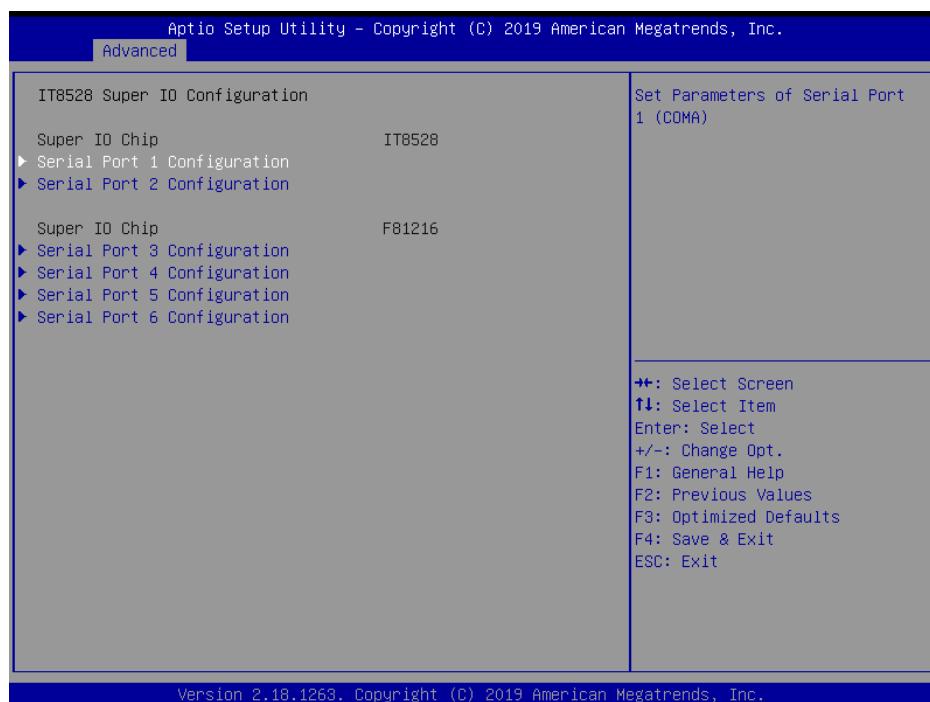

# ECM-KBLU User's Manual

Item	Description
<b>Serial Port 1 Configuration</b>	Set Parameters of Serial Port 1 (COMA).
<b>Serial Port 2 Configuration</b>	Set Parameters of Serial Port 2 (COMB).
<b>Serial Port 3 Configuration</b>	Set Parameters of Serial Port 3 (COMC).
<b>Serial Port 4 Configuration</b>	Set Parameters of Serial Port 4 (COMD).
<b>Serial Port 5 Configuration</b>	Set Parameters of Serial Port 5 (COME).
<b>Serial Port 6 Configuration</b>	Set Parameters of Serial Port 6 (COMF).

## 3.6.2.6.1 Serial Port 1 Configuration



Item	Option	Description
<b>Serial Port</b>	Enabled <b>[Default]</b> , Disabled	Enable or Disable Serial Port (COM).

### 3.6.2.6.2 Serial Port 2 Configuration

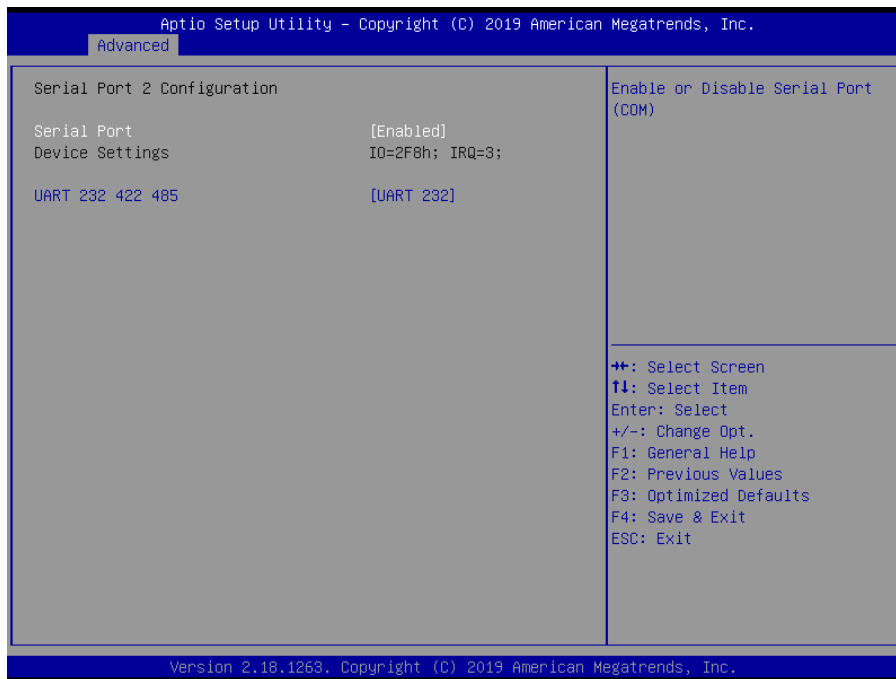

Item	Option	Description
Serial Port	Enabled[Default], Disabled	Enable or Disable Serial Port (COM).
UART 232 422 485	UART 232[Default] UART 422 UART 485	Change the Serial Port as RS232/422/485.

### 3.6.2.6.3 Serial Port 3 Configuration



## ECM-KBLU User's Manual

Item	Option	Description
Serial Port	Enabled[Default], Disabled	Enable or Disable Serial Port (COM).

### 3.6.2.6.4 Serial Port 4 Configuration

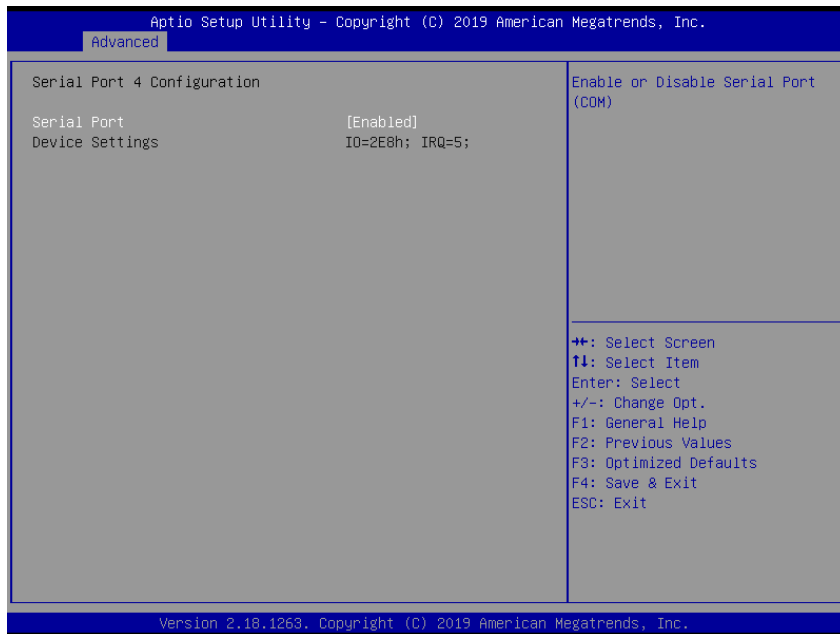

Item	Option	Description
Serial Port	Enabled[Default], Disabled	Enable or Disable Serial Port (COM).

### 3.6.2.6.5 Serial Port 5 Configuration

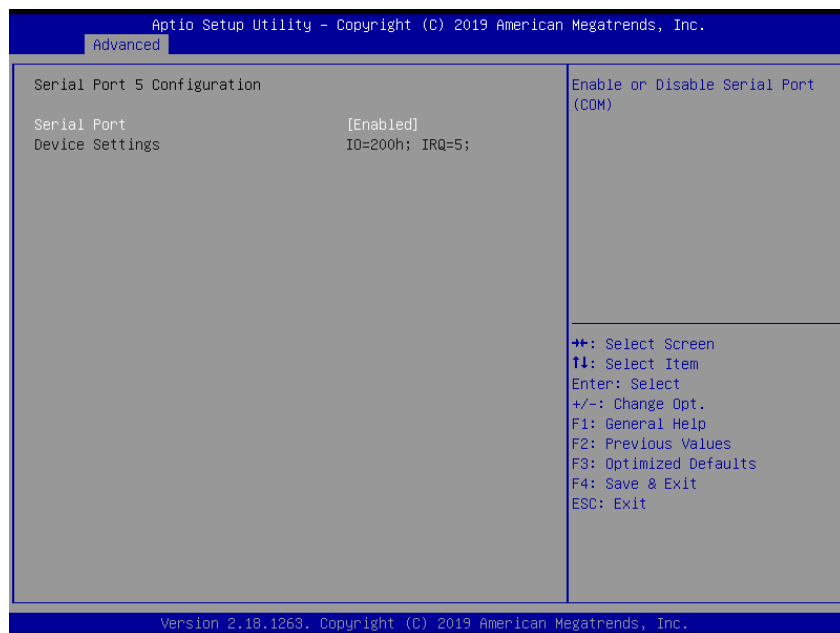

Item	Option	Description
Serial Port	Enabled[Default], Disabled	Enable or Disable Serial Port (COM).



### 3.6.2.6.6 Serial Port 6 Configuration

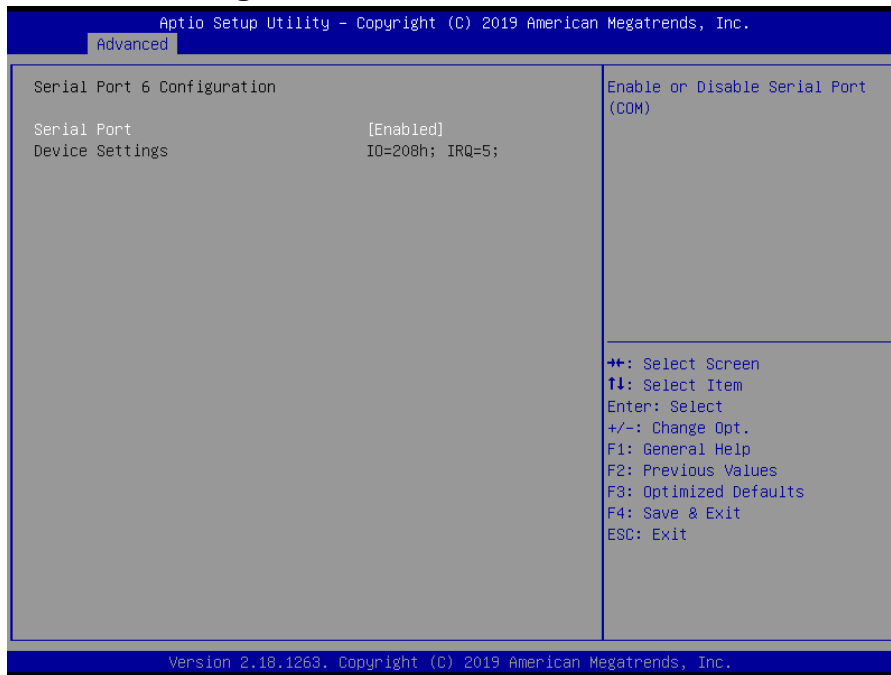

Item	Option	Description
Serial Port	Enabled[Default], Disabled	Enable or Disable Serial Port (COM).

### 3.6.2.7 HW Monitor

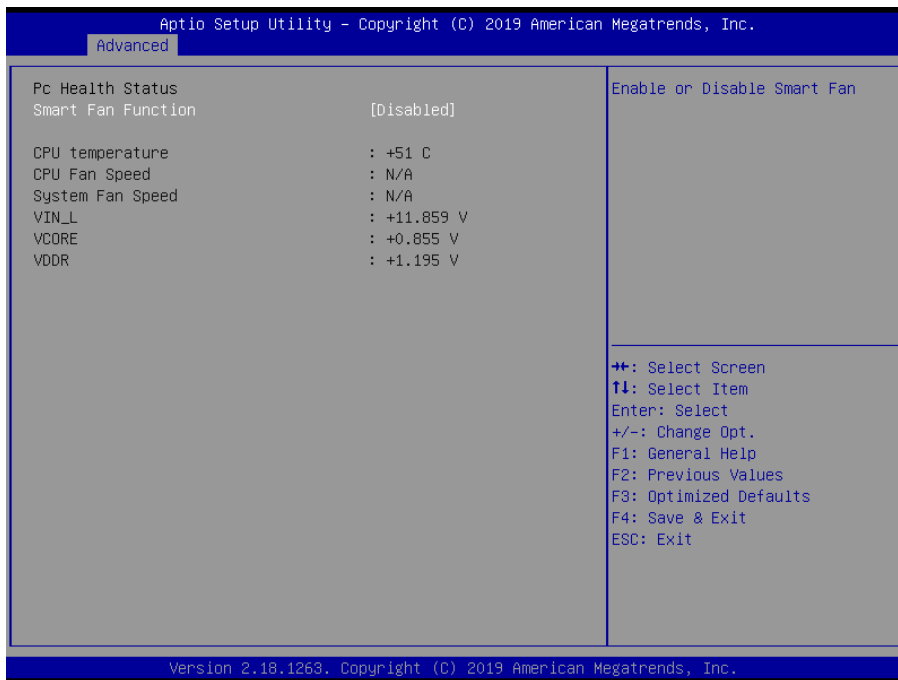

Item	Options	Description
Smart Fan Function	Enabled, Disabled[Default]	Enables or Disables Smart Fan.

3.6.2.8 S5 RTC Wake Settings

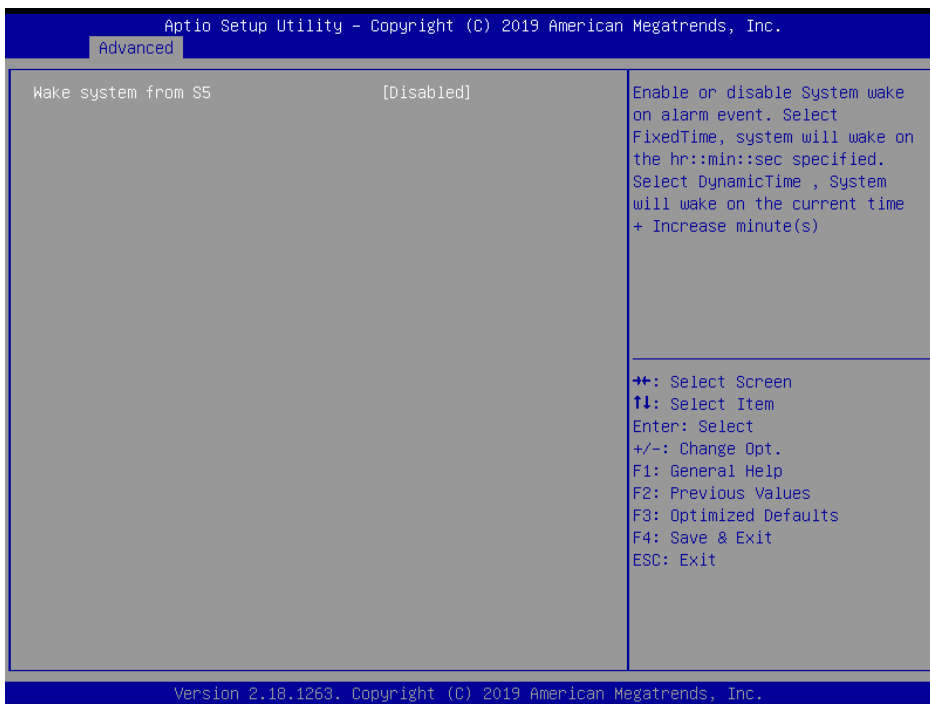

Item	Options	Description
Wake system from S5	Disabled[Default], Fixed Time Dynamic Time	Enable or disable System wake on alarm event. Select Fixed Time, system will wake on the hr::min::sec specified. Select Dynamic Time, System will wake on the current time + Increase minute(s).

3.6.2.9 Serial Port Console Redirection

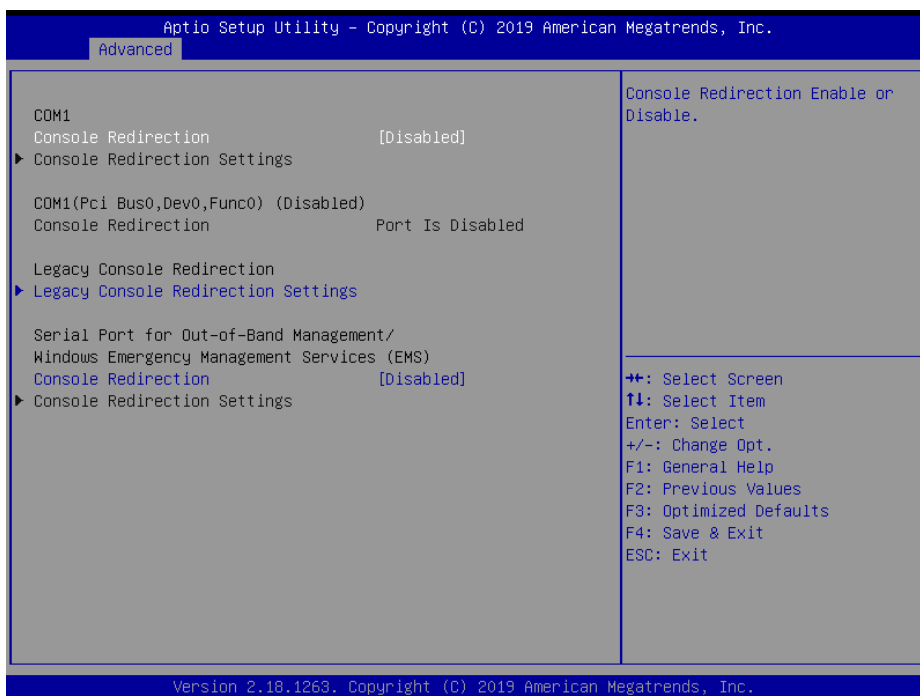

Item	Options	Description
Console Redirection	Disabled[Default], Enabled	Console Redirection Enable or Disable.

### 3.6.2.9.1 Legacy Console Redirection Settings



Item	Option	Description
Legacy Serial Redirection Port	COM1[Default]	Select a COM port to display redirection of Legacy OS and Legacy OPROM Messages.

### 3.6.2.10 Intel TXT Configuration

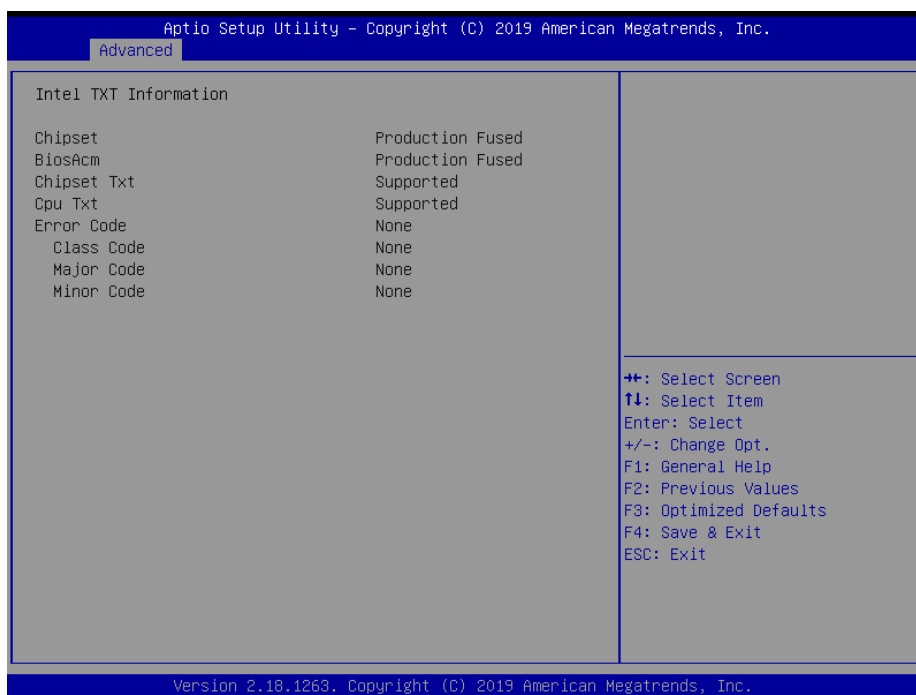

3.6.2.11 Network Stack Configuration

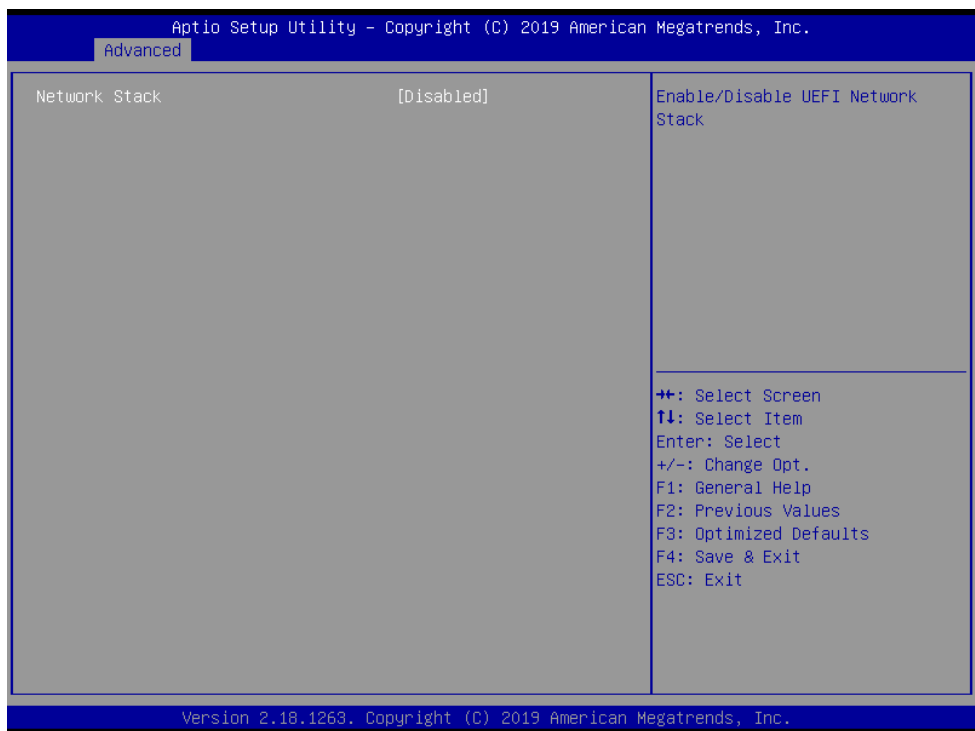

Item	Options	Description
Network Stack	Enabled Disabled[Default]	Enable/Disable UEFI Network Stack.

3.6.2.12 CSM Configuration

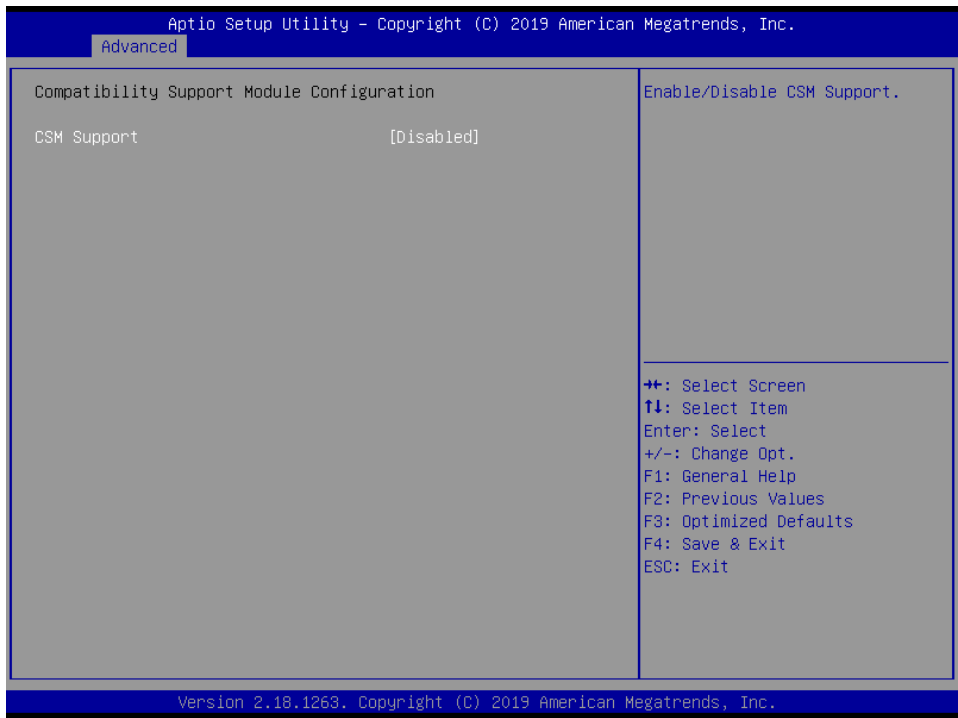

Item	Options	Description
CSM Support	Enabled Disabled[Default]	Enable/Disable CSM Support.

### 3.6.2.13 NVMe Configuration

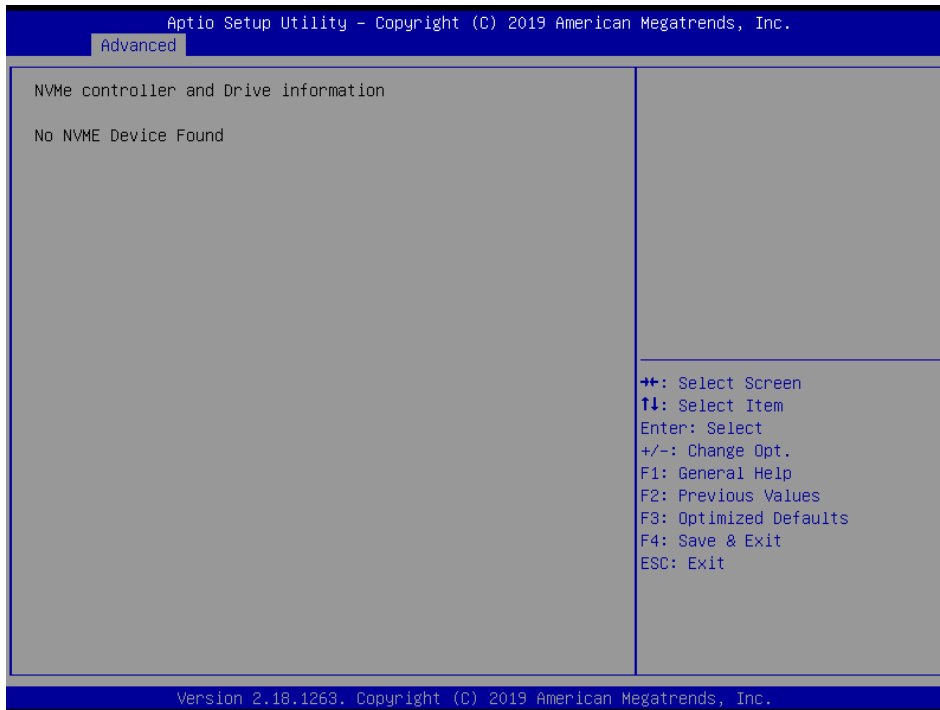

### 3.6.2.14 USB Configuration

The USB Configuration menu helps read USB information and configures USB settings.



## ECM-KBLU User's Manual

Item	Options	Description
<b>Legacy USB Support</b>	Enabled[Default] Disabled Auto	Enables Legacy USB support. AUTO option disables legacy support if no USB devices are connected. DISABLE option will keep SUB devices available only for EFI applications.
<b>XHCI Hand-off</b>	Enabled[Default] Disabled	This is a workaround for OSes without XHCI hand-off support. The XHCI ownership change should be claimed by XHCI driver.
<b>USB Mass Storage Driver Support</b>	Enabled[Default] Disabled	Enable/Disable USB Mass Storage Driver Support.
<b>Port 60/64 Emulation</b>	Enabled Disabled[Default]	Enable I/O port 60h/64h emulation support. This should be enabled for the complete USB keyboard legacy support for non-USB aware OSes.
<b>USB transfer time-out</b>	1 sec 5 sec 10 sec 20 sec[Default]	The time-out value for Control, Bulk, and Interrupt transfers.
<b>Device reset time-out</b>	10 sec 20 sec[Default] 30 sec 40 sec	USB mass storage device Start Unit command time-out.
<b>Device power-up delay</b>	Auto[Default] Manual	Maximum time the device will take before it properly reports itself to the Host Controller. 'Auto' uses default value: for a Root port it is 100ms, for a Hub port the delay is taken from Hub descriptor.
<b>Mass Storage Devices</b>	Auto[Default] Floppy Forced FDD Hard Disk CD-ROM	Mass storage device emulation type. 'AUTO' enumerates devices according to their media format. Optical drives are emulated as 'CDROM', drives with no media will be emulated according to a drive type.

### 3.6.3 Chipset

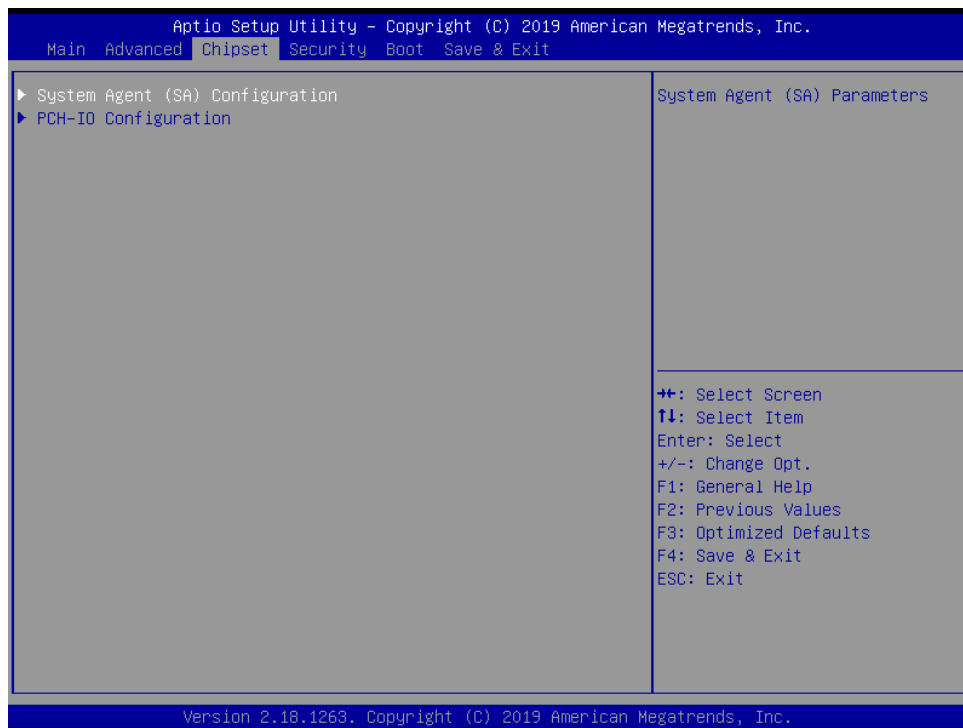

#### 3.6.3.1 System Agent (SA) Configuration

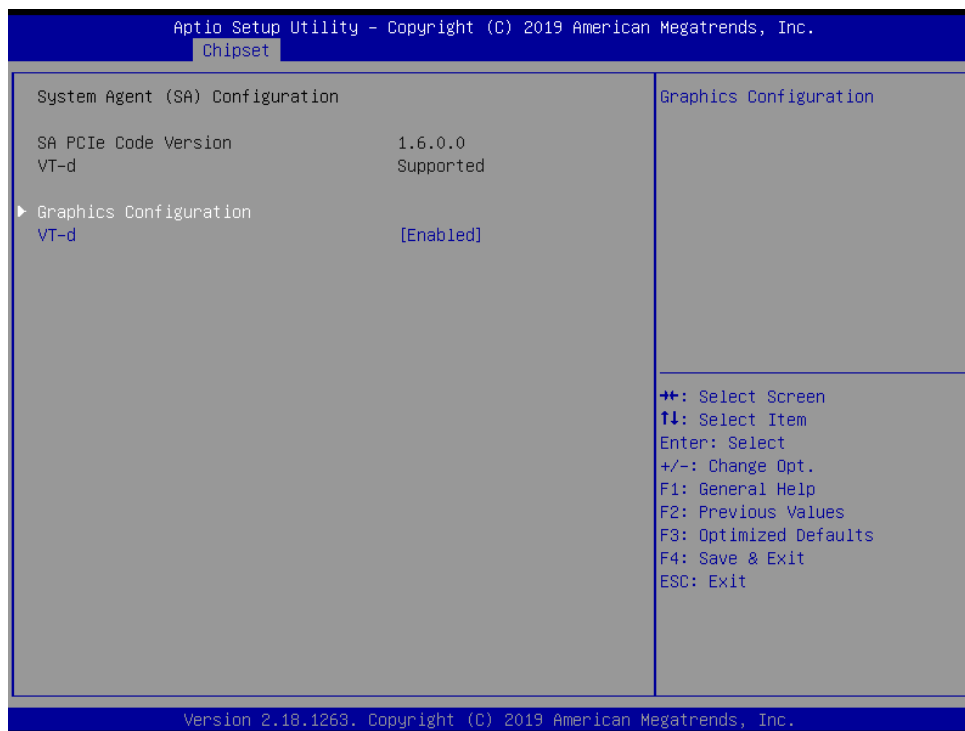

Item	Option	Description
VT-d	Enabled[Default] Disabled	VT-d capability.

3.6.3.1.1 Graphics Configuration

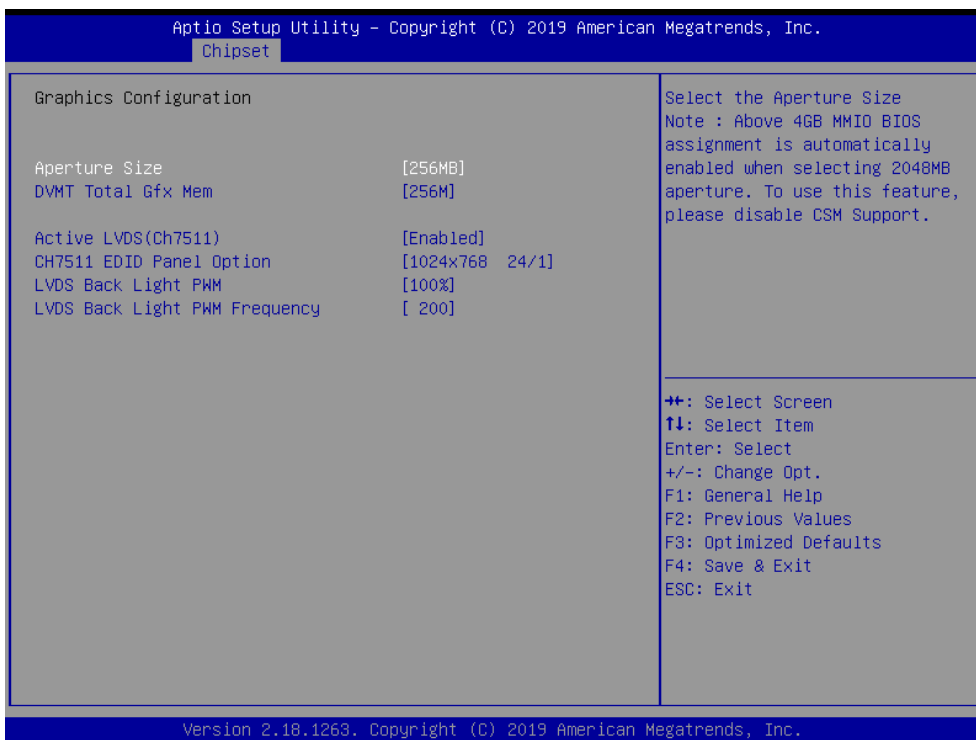

Item	Option	Description
Aperture Size	128MB 256MB[Default] 512MB 1024MB 2048MB	Select the Aperture Size. Note: Above 4GB MMIO BIOS assignment is automatically enabled when selecting 2048MB aperture. To use this feature, please disable CSM Support.
DVMT Total Gfx Mem	256M[Default] 128M MAX	Select DVMT 5.0 Total Graphics Memory size used by the Internal Graphics Device.
Active LVDS(Ch7511)	Disabled Enabled[Default]	Active Internal LVDS(eDP->Ch7511-to-LVDS).
Ch7511 EDID Panel Option	1024x768 24/1[Default] 800x600 18/1 1024x768 18/1 1366x768 18/1 1024x600 18/1 1280x800 18/1 1920x1200 24/2 1920x1080 18/2 1280x1024 24/2 1440x900 18/2 1600x1200 24/2 1366x768 24/1 1920x1080 24/2 1680x1050 24/2	Port1-EDP to LVDS (Chrotel 7511) Panel EDID Option.
LVDS Back Light PWM	0% 25%	Select back light PWM duty.



	50% 75% 100% <b>[Default]</b>	
<b>LVDS Back Light PWM Frequency</b>	200 <b>[Default]</b> 300 400 500 700 1K 2K 3K 5K 10K 20K	Select LVDS back light PWM Frequency.

### 3.6.3.2 PCH-IO Configuration

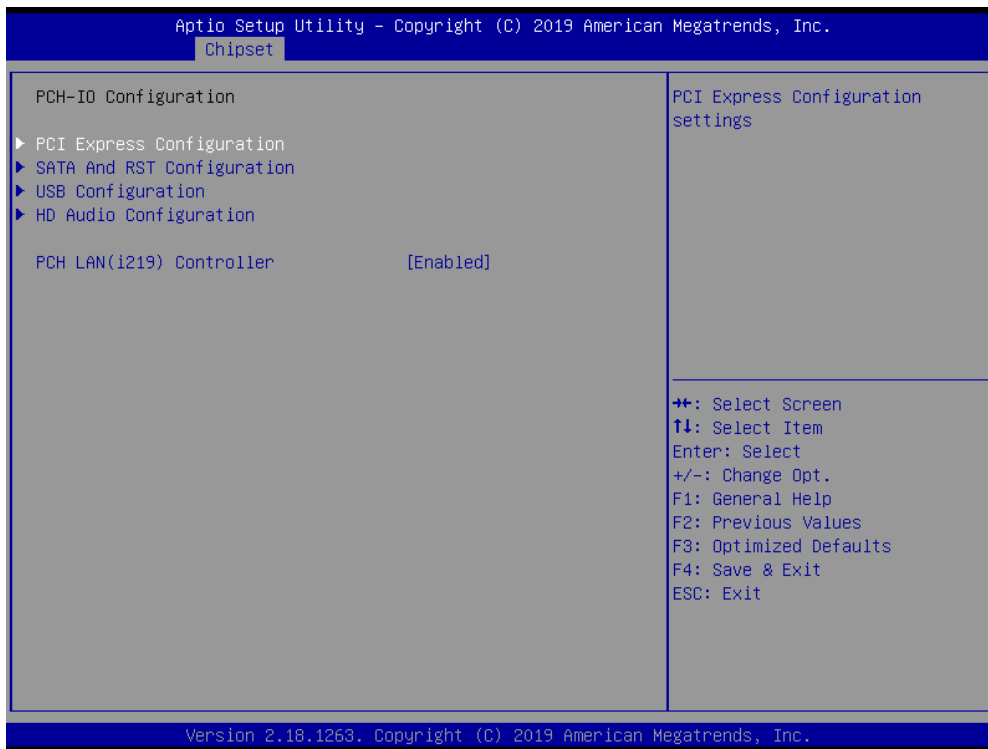

Item	Option	Description
<b>PCH LAN(i219) Controller</b>	Disabled Enabled <b>[Default]</b>	Enable/Disable onboard NIC.

3.6.3.2.1 PCI Express Configuration

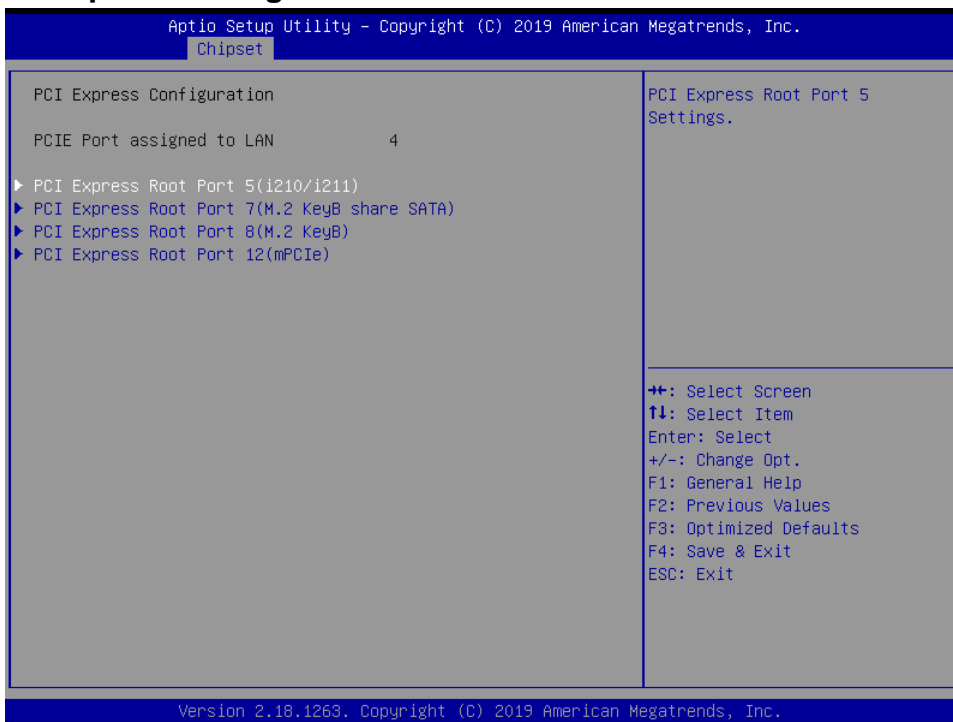

3.6.3.2.1.1 PCI Express Root Port 5(i210/i211)

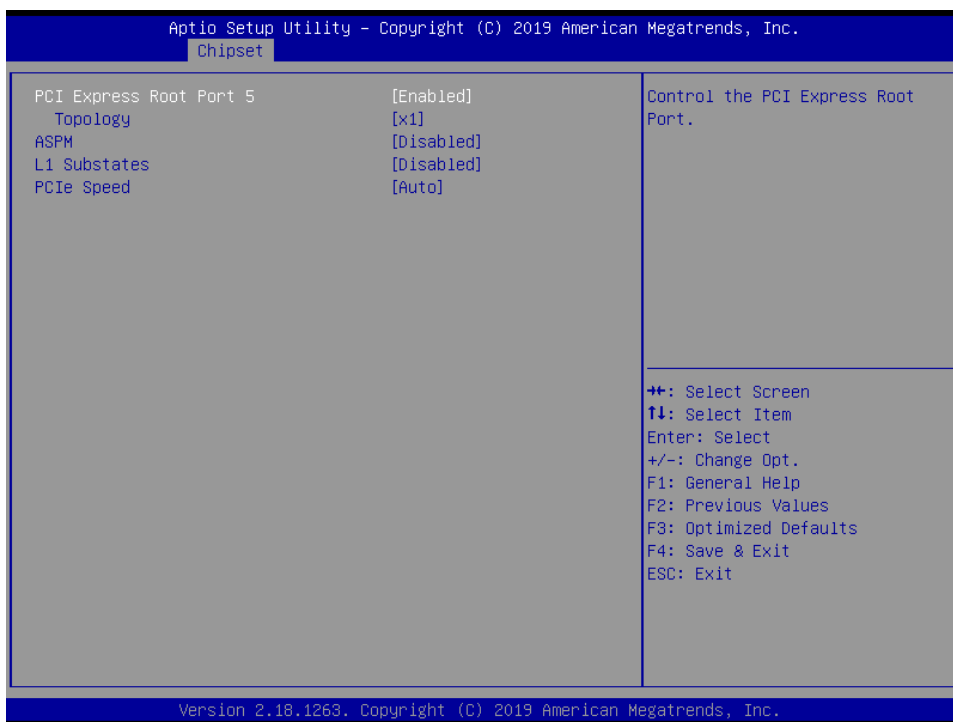

Item	Option	Description
PCI Express Root Port 5	Enabled[Default], Disabled	Control the PCI Express Root Port.
Topology	Unknown x1[Default]	Identify the SATA Topology if it is Default or ISATA or Flex or DirectConnect or M2.

	x4 Sata Express M2	
<b>ASPM</b>	Disabled[Default], L0sL1 L1 L0s Auto	Set the ASPM Level: Force L0s – Force all links to L0s State AUTO – BIOS auto configure DISABLE – Disables ASPM.
<b>L1 Substates</b>	Disabled[Default], L1.1 L1.2 L1.1 & L1.2	PCI Express L1 Substates settings.
<b>PCIe Speed</b>	Auto[Default] Gen1 Gen2 Gen3	Configure PCIe Speed.

### 3.6.3.2.1.2 PCI Express Root Port 7(M.2 KeyB share SATA)

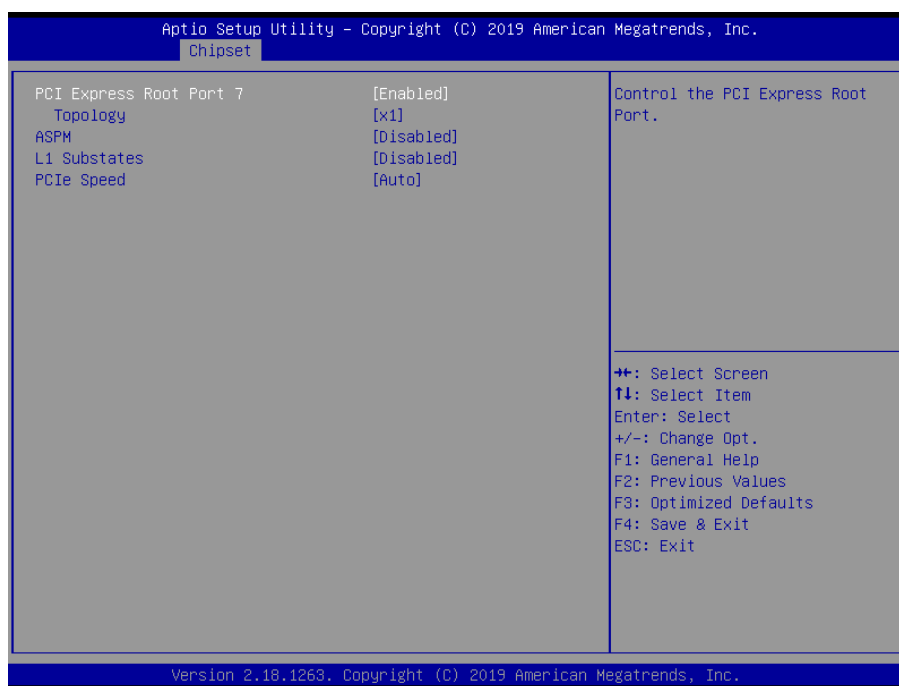

Item	Option	Description
<b>PCI Express Root Port 7</b>	Enabled[Default], Disabled	Control the PCI Express Root Port.
<b>Topology</b>	Unknown x1[Default] x4 Sata Express M2	Identify the SATA Topology if it is Default or ISATA or Flex or DirectConnect or M2.
<b>ASPM</b>	Disabled[Default], L0s L1	Set the ASPM Level: Force L0s – Force all links to L0s State AUTO – BIOS auto configure DISABLE – Disables ASPM.

## ECM-KBLU User's Manual

	L0sL1 Auto	
<b>L1 Substates</b>	Disabled[Default], L1.1 L1.2 L1.1 & L1.2	PCI Express L1 Substates settings.
<b>PCIe Speed</b>	Auto[Default] Gen1 Gen2 Gen3	Configure PCIe Speed.

### 3.6.3.2.1.3 PCI Express Root Port 8(M.2 KeyB)

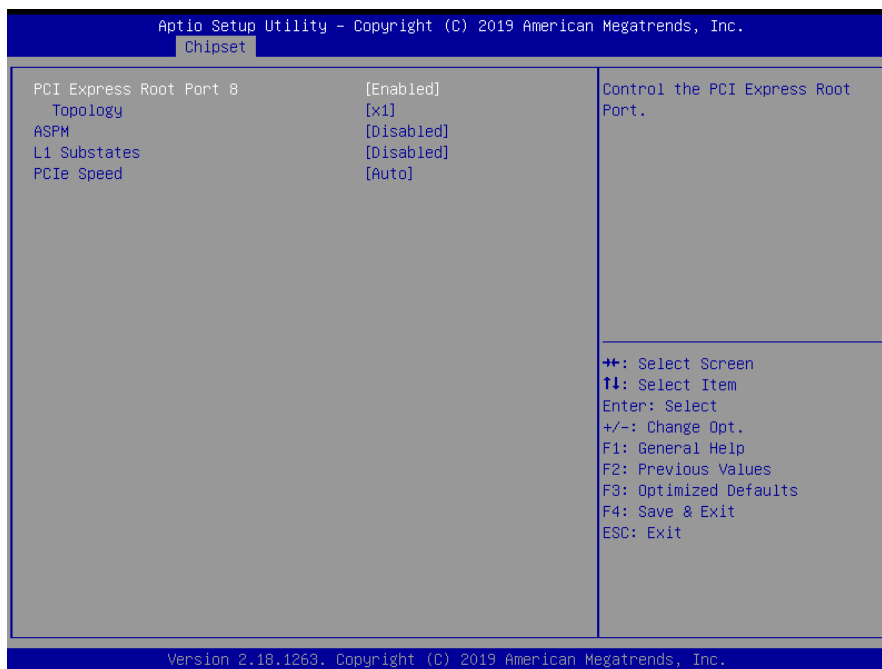

Item	Option	Description
<b>PCI Express Root Port 8</b>	Enabled[Default], Disabled	Control the PCI Express Root Port.
<b>Topology</b>	Unknown x1[Default], x4 Sata Express M2	Identify the SATA Topology if it is Default or ISATA or Flex or DirectConnect or M2.
<b>ASPM</b>	Disabled[Default], L0s L1 L0sL1 Auto	Set the ASPM Level: Force L0s – Force all links to L0s State AUTO – BIOS auto configure DISABLE – Disables ASPM.
<b>L1 Substates</b>	Disabled[Default], L1.1 L1.2 L1.1 & L1.2	PCI Express L1 Substates settings.

<b>PCIe Speed</b>	Auto[Default] Gen1 Gen2 Gen3	Configure PCIe Speed.
-------------------	---------------------------------------	-----------------------

### 3.6.3.2.1.4 PCI Express Root Port 12(mPCIe)

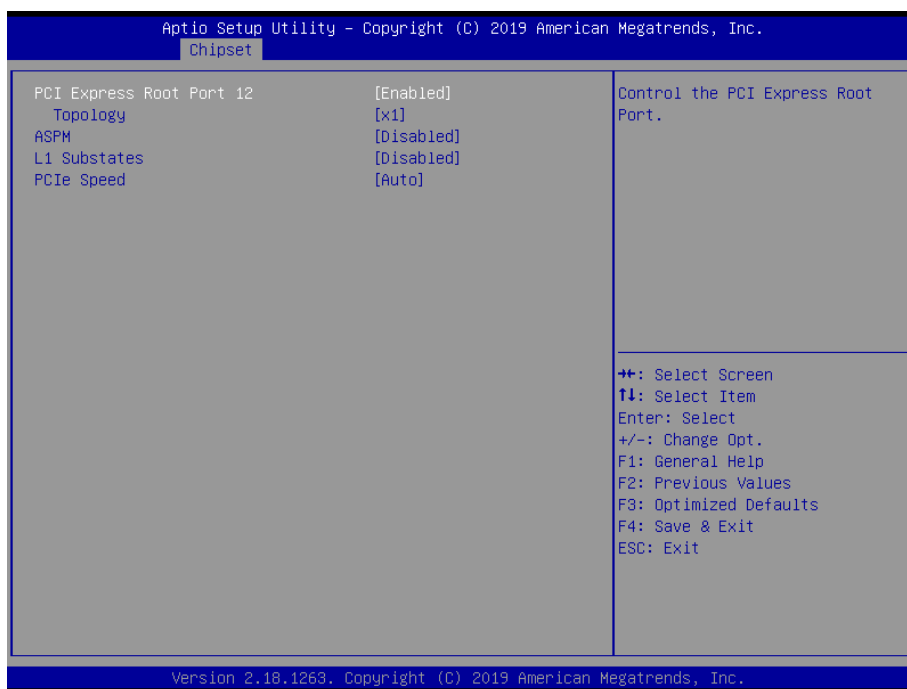

Item	Option	Description
<b>PCI Express Root Port 12</b>	Enabled[Default], Disabled	Control the PCI Express Root Port.
<b>Topology</b>	Unknown x1[Default], x4 Sata Express M2	Identify the SATA Topology if it is Default or ISATA or Flex or DirectConnect or M2.
<b>ASPM</b>	Disabled[Default], L0s L1 L0sL1 Auto	Set the ASPM Level: Force L0s – Force all links to L0s State AUTO – BIOS auto configure DISABLE – Disables ASPM.
<b>L1 Substates</b>	Disabled[Default], L1.1 L1.2 L1.1 & L1.2	PCI Express L1 Substates settings.
<b>PCIe Speed</b>	Auto[Default] Gen1 Gen2 Gen3	Configure PCIe Speed.

3.6.3.2.2 SATA And RST Configuration

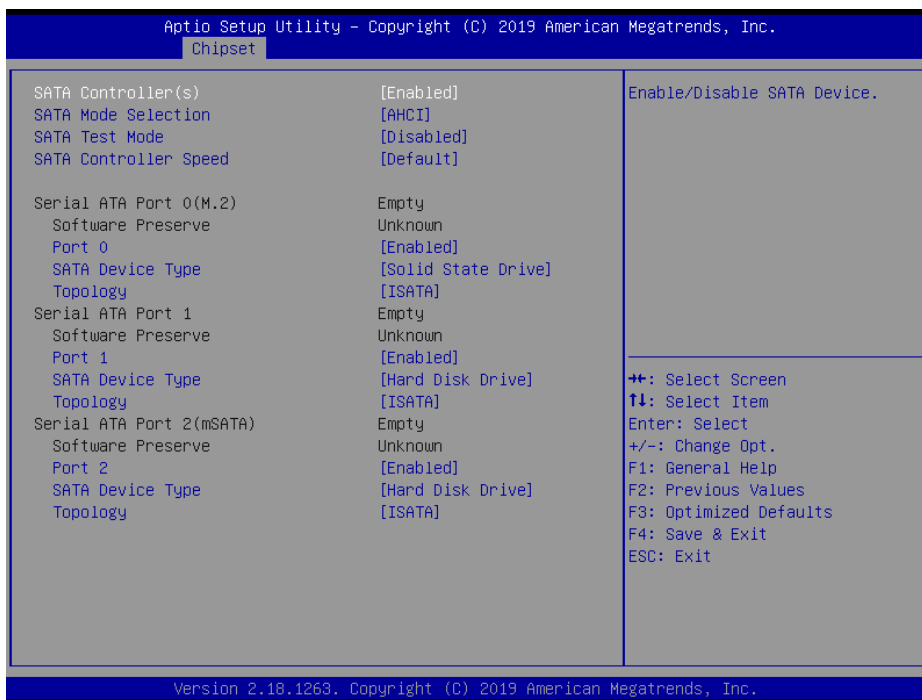

Item	Options	Description
<b>SATA Controller(s)</b>	Enabled[Default] Disabled,	Enable/Disable SATA Device.
<b>SATA Mode Selection</b>	AHCI[Default], RAID	Determines how SATA controller(s) operate.
<b>SATA Test Mode</b>	Enabled Disabled[Default]	Test Mode Enable/Disable (Loop Back).
<b>SATA Controller Speed</b>	Default[Default] Gen1 Gen2 Gen3	Indicates the maximum speed the SATA controller can support.
<b>Port 0</b>	Enabled[Default] Disabled	Enable or Disable SATA Port.
<b>SATA Device Type</b>	Hard Disk Drive Solid State Drive[Default]	Identify the SATA port is connected to Solid State Drive or Hard Disk Drive.
<b>Topology</b>	Unknown ISATA[Default] Direct Connect Flex M2	Identify the SATA Topology if it is Default or ISATA or Flex or DirectConnect or M2.
<b>Port 1</b>	Enabled[Default] Disabled	Enable or Disable SATA Port.
<b>SATA Device Type</b>	Hard Disk Drive[Default] Solid State Drive	Identify the SATA port is connected to Solid State Drive or Hard Disk Drive.

<b>Topology</b>	Unknown ISATA[Default] Direct Connect Flex M2	Identify the SATA Topology if it is Default or ISATA or Flex or DirectConnect or M2.
<b>Port 2</b>	Enabled[Default] Disabled	Enable or Disable SATA Port.
<b>SATA Device Type</b>	Hard Disk Drive[Default] Solid State Drive	Identify the SATA port is connected to Solid State Drive or Hard Disk Drive.
<b>Topology</b>	Unknown ISATA[Default] Direct Connect Flex M2	Identify the SATA Topology if it is Default or ISATA or Flex or DirectConnect or M2.

### 3.6.3.2.3 USB Configuration

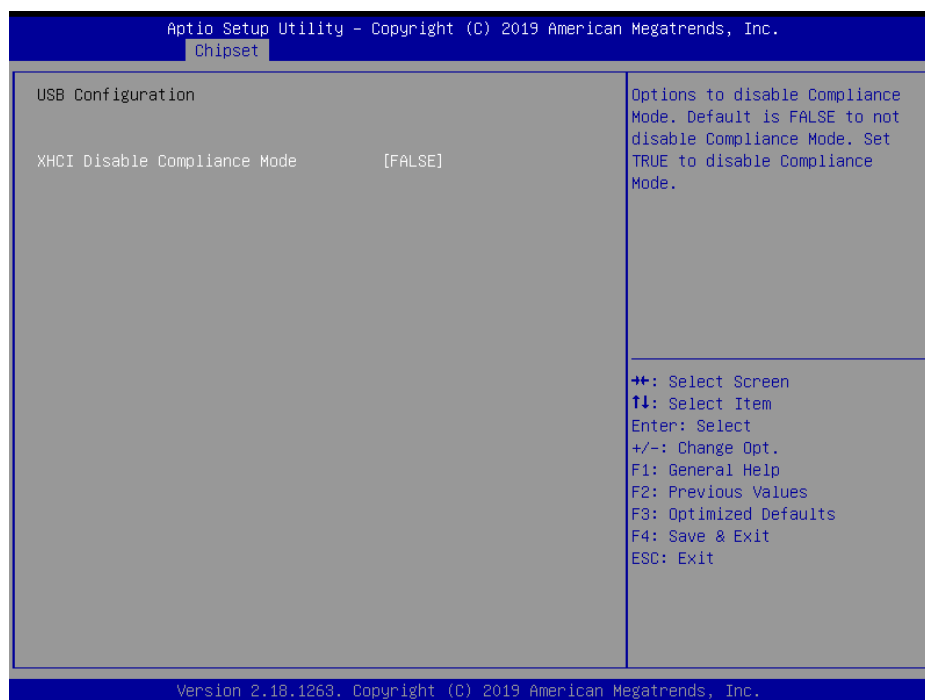

Item	Option	Description
<b>XHCI Disable Compliance Mode</b>	FALSE[Default], TRUE	Option to disable Compliance Mode. Default is FALSE to not disable Compliance Mode. Set TRUE to disable Compliance Mode.

3.6.3.2.4 HD Audio Configuration

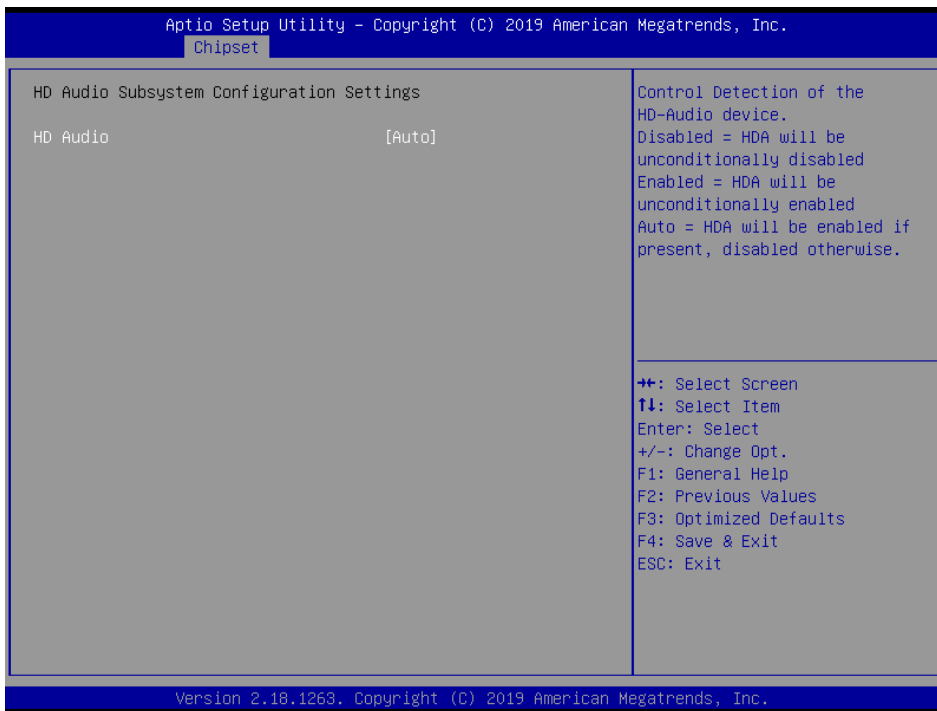

Item	Option	Description
HD Audio	Disabled Enabled Auto[Default],	Control Detection of the HD-Audio device. Disable = HDA will be unconditionally disabled Enabled = HDA will be unconditionally enabled Auto = HDA will be enabled if present, disabled otherwise.

3.6.4 Security

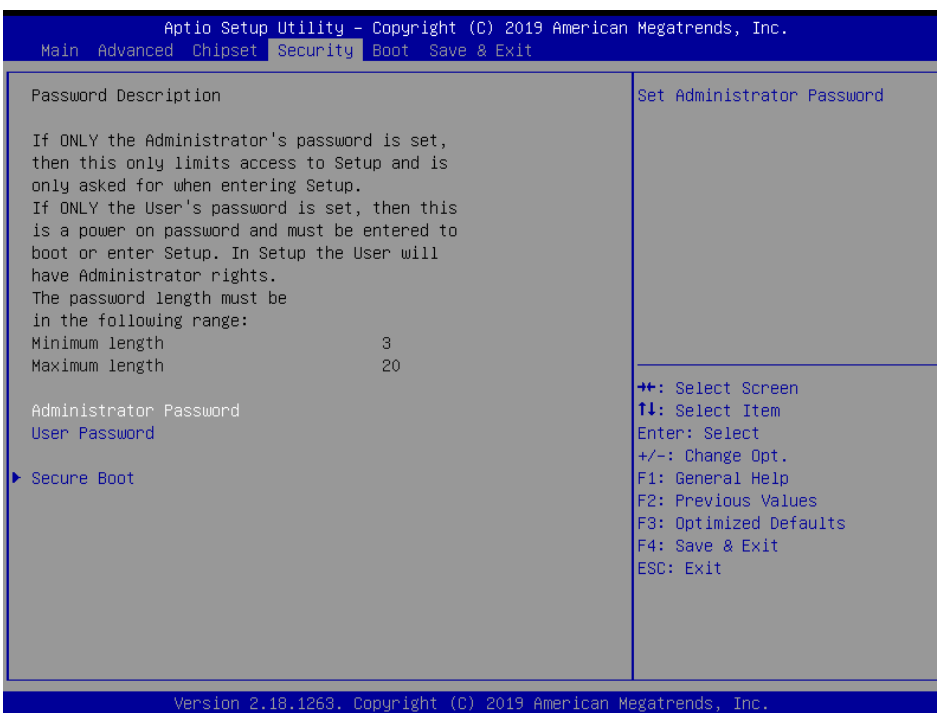



- **Administrator Password**

Set setup Administrator Password

- **User Password**

Set User Password

### 3.6.4.1 Secure Boot

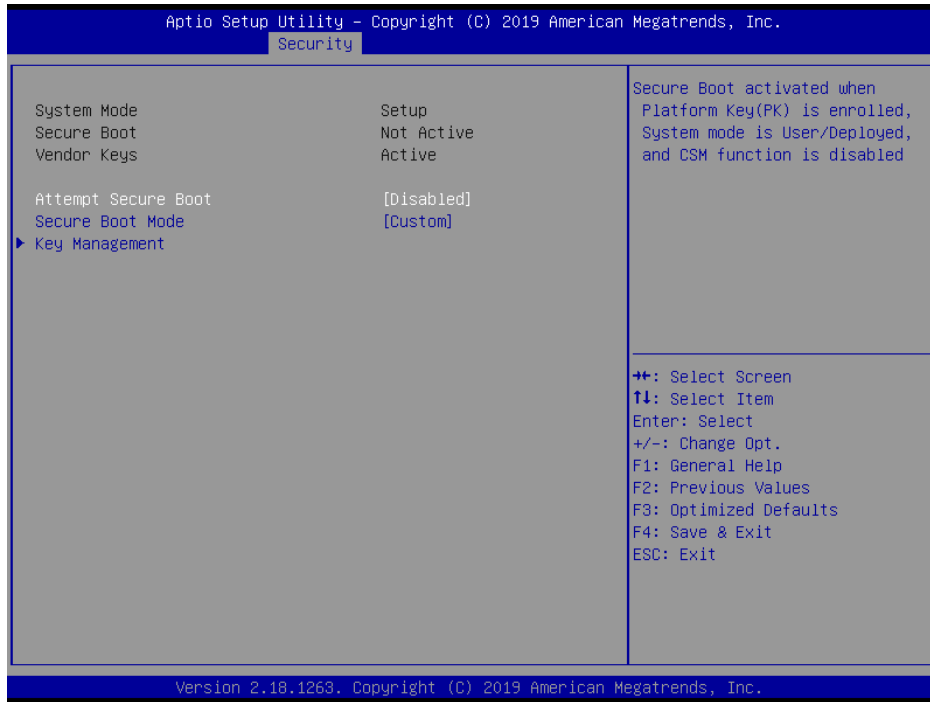

Item	Option	Description
<b>Attempt Secure Boot</b>	Disabled[Default] Enabled	Secure Boot can be enabled if 1.System running in User mode with enrolled Platform Key(PK) 2.CSM function is disabled.
<b>Secure Boot Mode</b>	Standard Custom[Default]	Secure Boot mode selector: Standard/Custom. In Custom mode Secure Boot Variables can be configured without authentication.

# ECM-KBLU User's Manual

## 3.6.4.1.1 Key Management

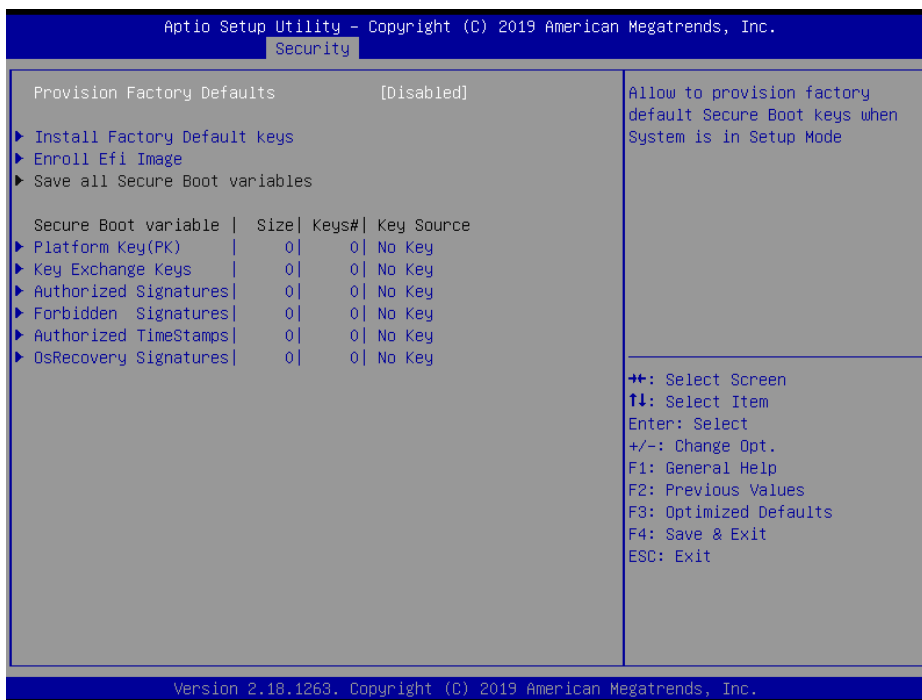

Item	Option	Description
Provision Factory Defaults	Disabled[Default] Enabled	Allow to provision factory default Secure Boot keys when System is in Setup Mode.

## 3.6.5 Boot

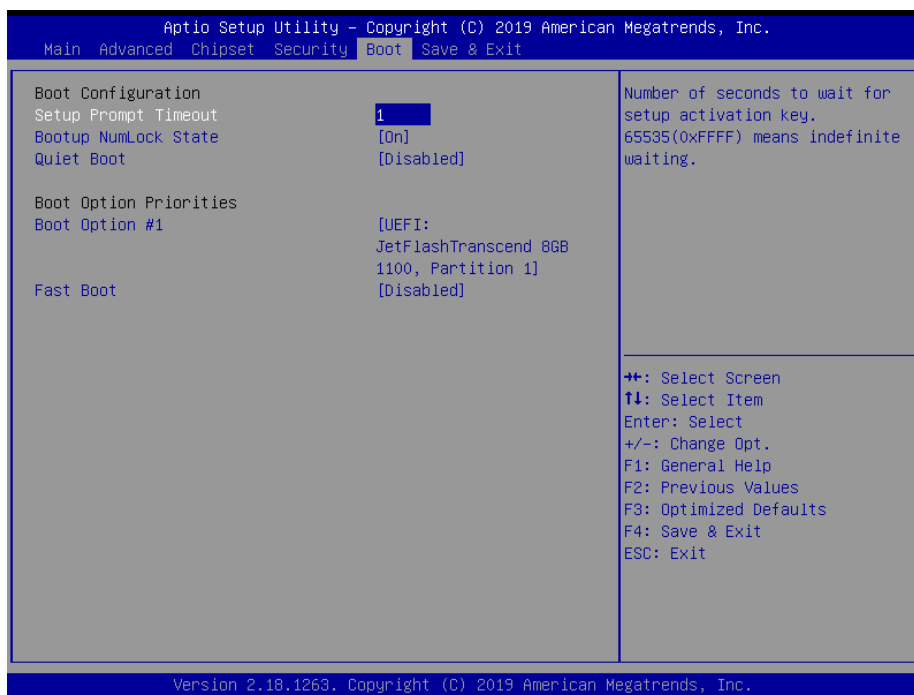

Item	Option	Description
Setup Prompt Timeout	1~ 65535	Number of seconds to wait for setup activation

		key. 65535(0xFFFF) means indefinite waiting.
<b>Bootup NumLock State</b>	On[Default] Off	Select the Keyboard NumLock state
<b>Quiet Boot</b>	Disabled[Default] Enabled	Enables or disables Quiet Boot option
<b>Fast Boot</b>	Disabled[Default] Enabled	Enables or disables boot with initialization of a minimal set of devices required to launch active boot option. Has no effect for BBS boot options.
<b>Boot Option #1</b>	Set the system boot order.	

### 3.6.6 Save and exit

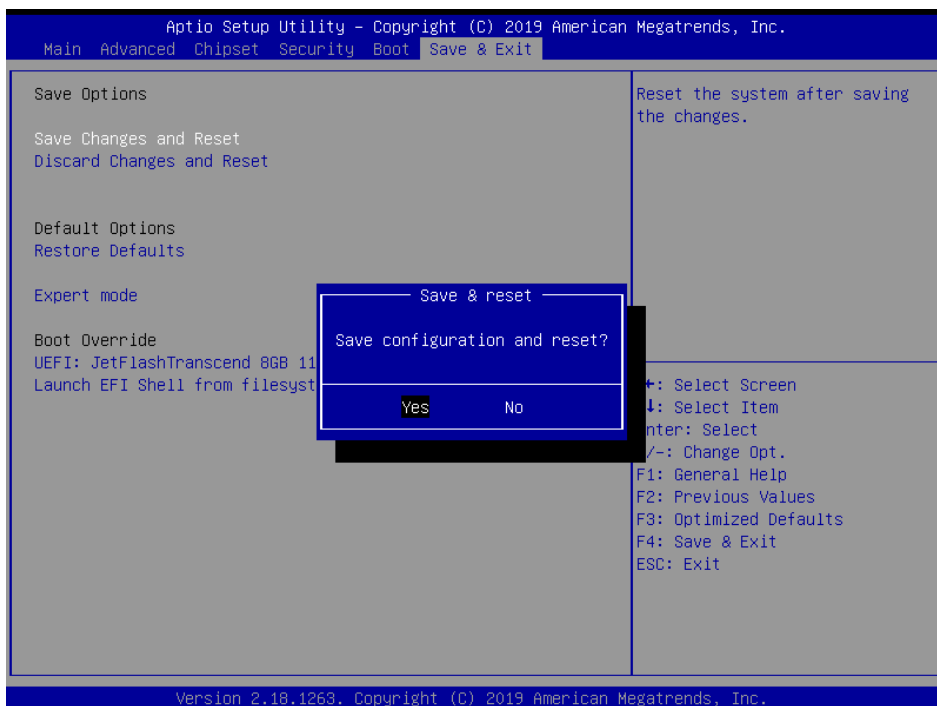
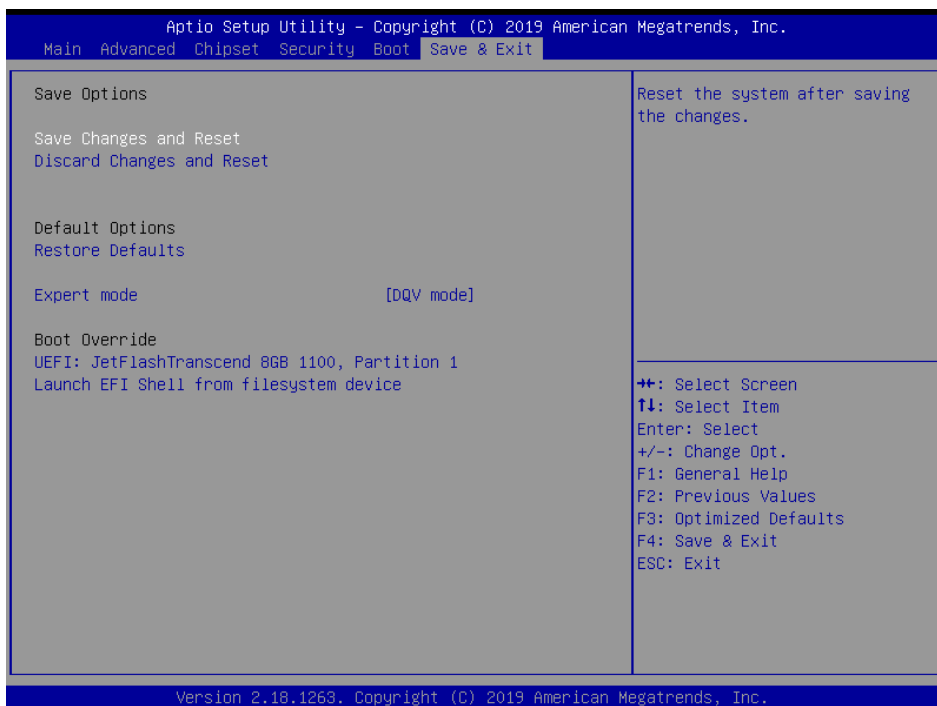

## **ECM-KBLU User's Manual**

### **3.6.6.1 *Save Changes and Reset***

Reset the system after saving the changes.

### **3.6.6.2 *Discard Changes and Reset***

Any changes made to BIOS settings during this session of the BIOS setup program are discarded. The setup program then exits and reboots the controller.

### **3.6.6.3 *Restore Defaults***

This option restores all BIOS settings to the factory default. This option is useful if the controller exhibits unpredictable behavior due to an incorrect or inappropriate BIOS setting.

### **3.6.6.4 *Launch EFI Shell from filesystem device***

Attempts to Launch EFI Shell application (Shellx64.efi) from one of the available filesystem devices.

# 4. Drivers Installation

---



**Note:** Installation procedures and screen shots in this section are for your reference and may not be exactly the same as shown on your screen.

## 4.1 Install Chipset Driver



**Note:** The installation procedures and screen shots in this section are based on Windows 10 operation system. If the warning message appears while the installation process, click Continue to go on.

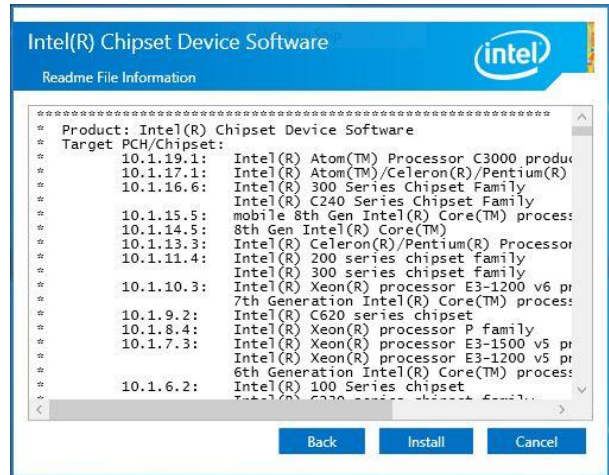

**Step 3. Click Install.**



**Step1. Click Next.**



**Step 4. Setup completed.**



**Step 2. Click Accept.**

## 4.2 Install ME Driver



**Note:** The installation procedures and screen shots in this section are based on Windows 10 operation system. If the warning message appears while the installation process, click Continue to go on.

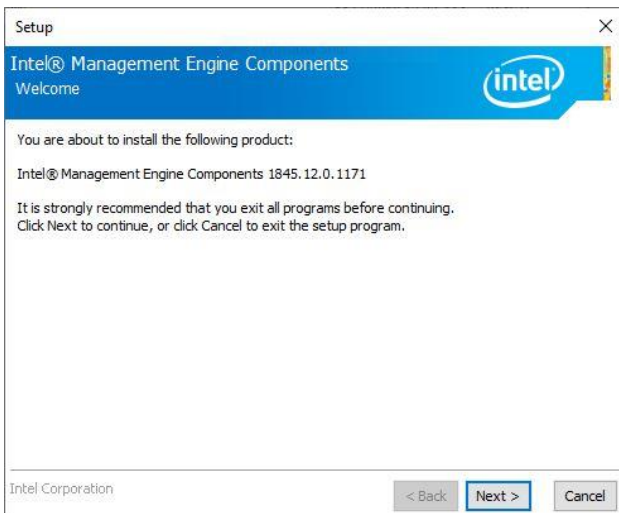

**Step1.** Click **Next** to start installation.



**Step 2.** Click **Next**.

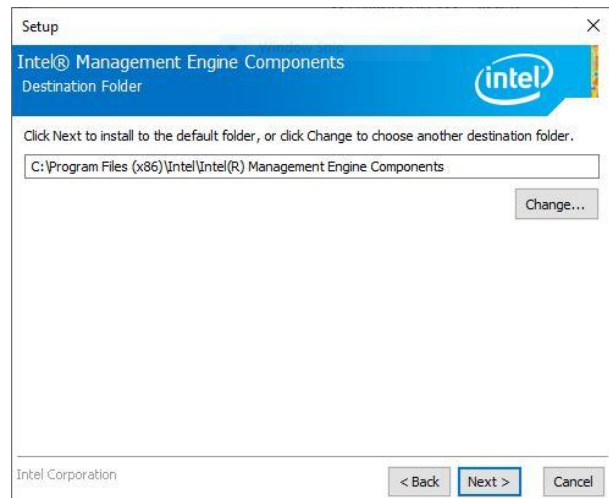

**Step 3.** Click **Next** to continue installation.

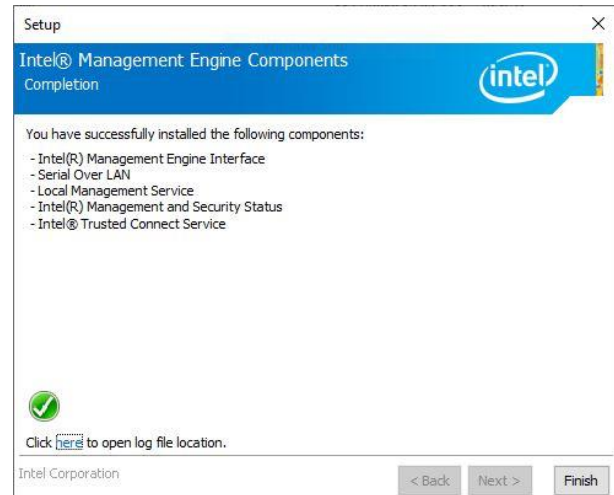

**Step 4.** Click **Finish** to complete setup.

## 4.3 Install VGA Driver



**Note:** The installation procedures and screen shots in this section are based on Windows 10 operation system.

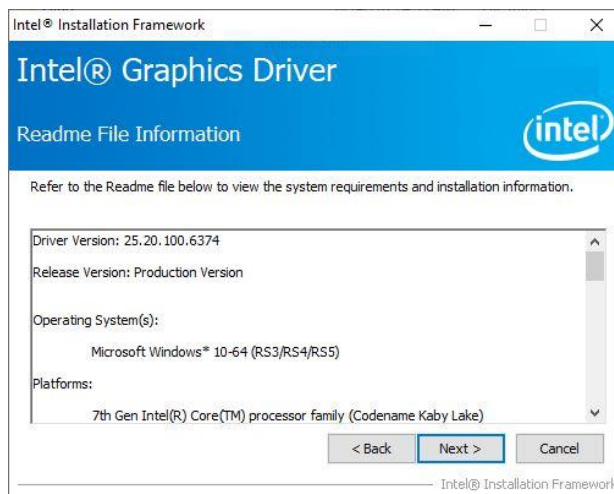

**Step 3. Click Next.**

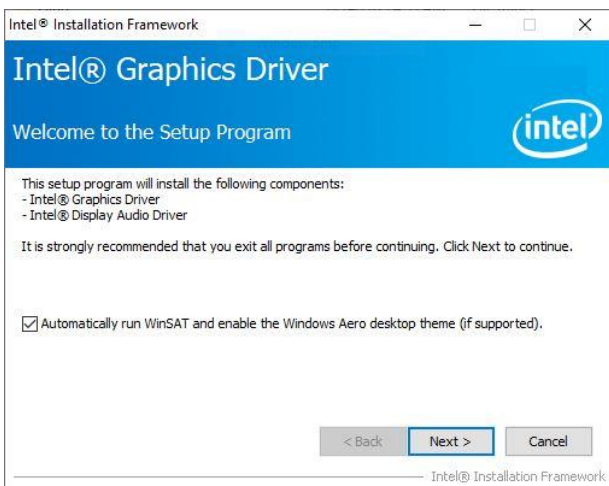

**Step 1. Click Next** to continue installation.

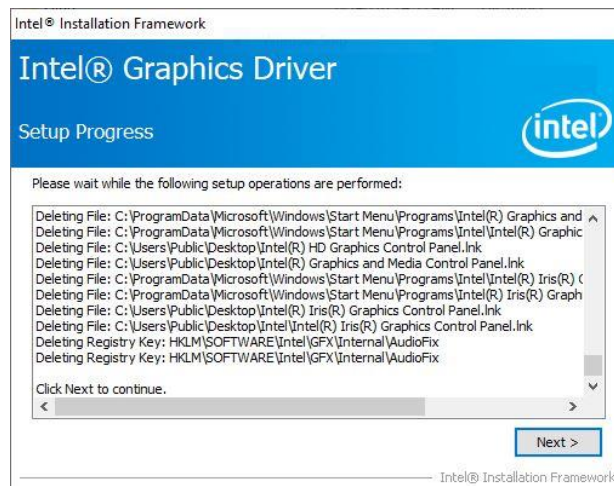

**Step 4. Click Next.**

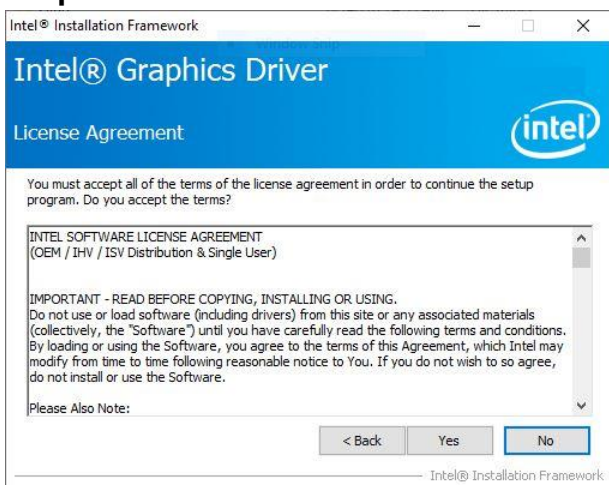

**Step 2.**

Click **Yes** to accept license agreement.

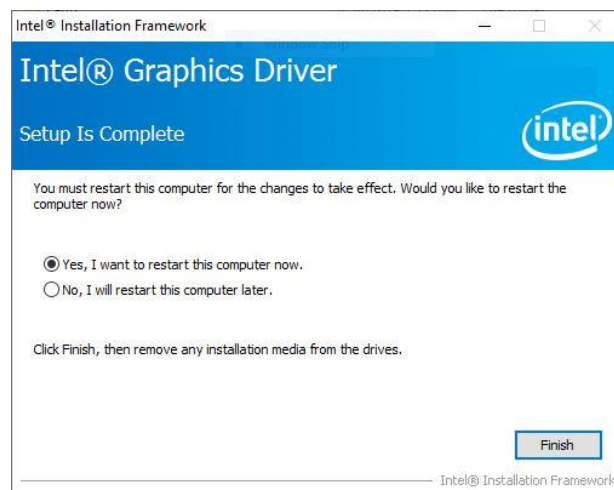

**Step 5. Click Finish** to complete setup.



## 4.4 Install Audio Driver (For Realtek ALC892)



**Note:** The installation procedures and screen shots in this section are based on Windows 10 operation system.

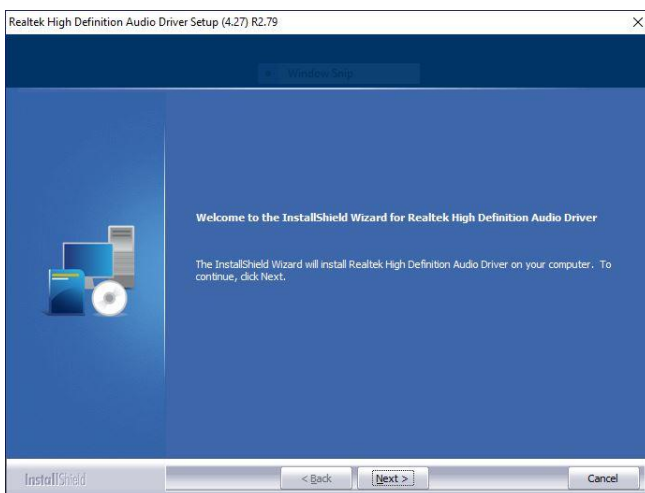

**Step 1.** Click **Next** to continue setup.

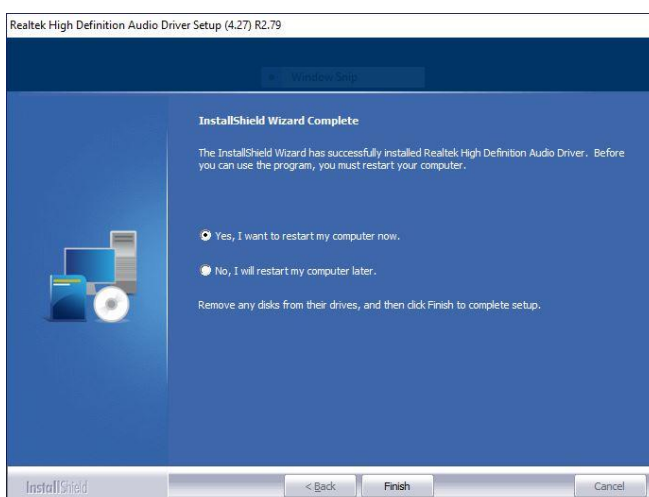

**Step 2.** Click **Finish** to complete the setup.

## 4.5 Install Ethernet Driver



**Note:** The installation procedures and screen shots in this section are based on Windows 10 operation system.

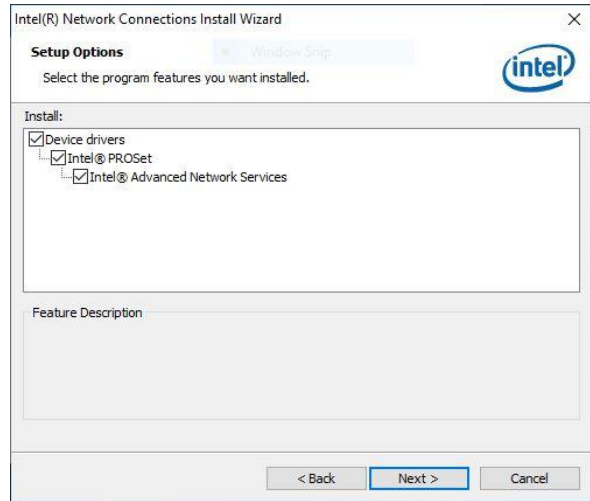

**Step 3. Click Next.**

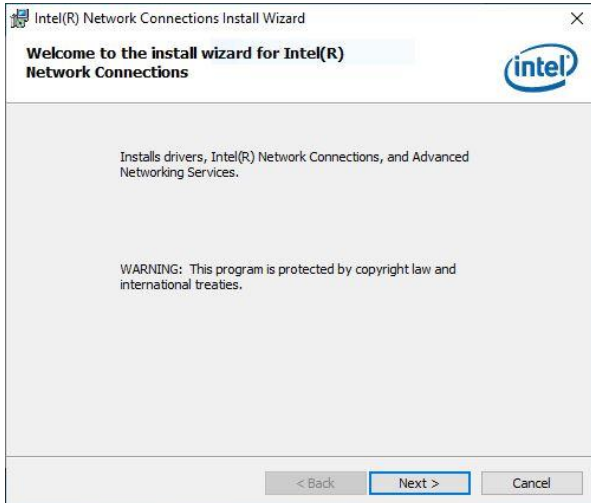

**Step 1. Click Next** to continue installation.

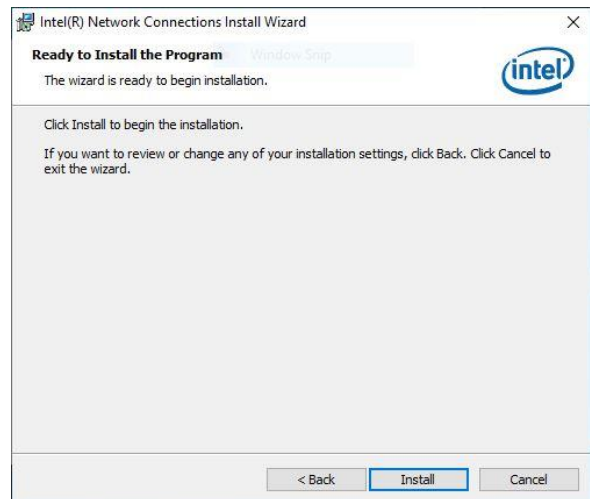

**Step 4. Click Install.**

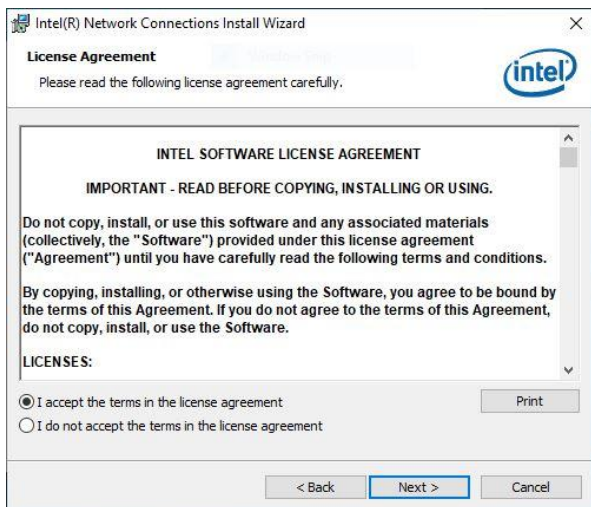

**Step 2. Click Next.**

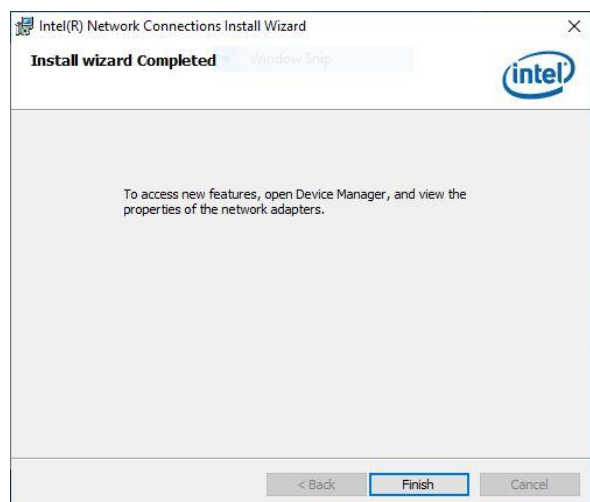

**Step 5. Click Finish** to complete setup.

## 4.6 Install Serial IO Driver



**Note:** The installation procedures and screen shots in this section are based on Windows 10 operation system.

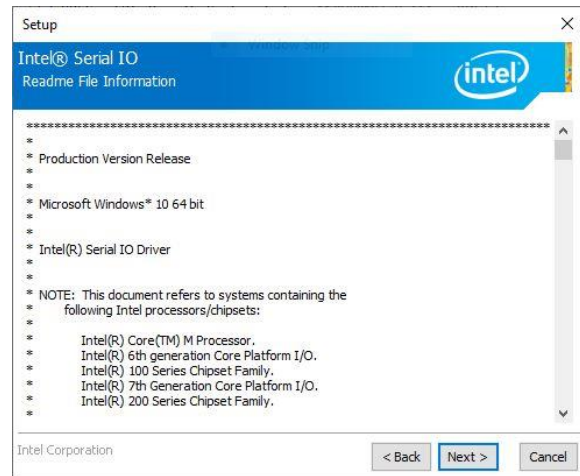

**Step 3. Click Next.**

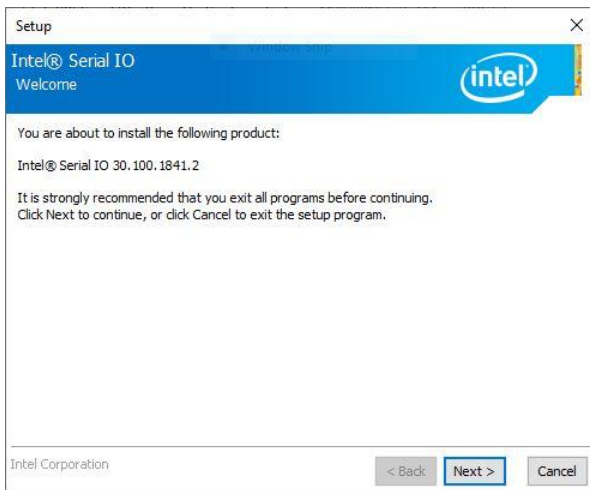

**Step 1. Click Next** to continue installation.

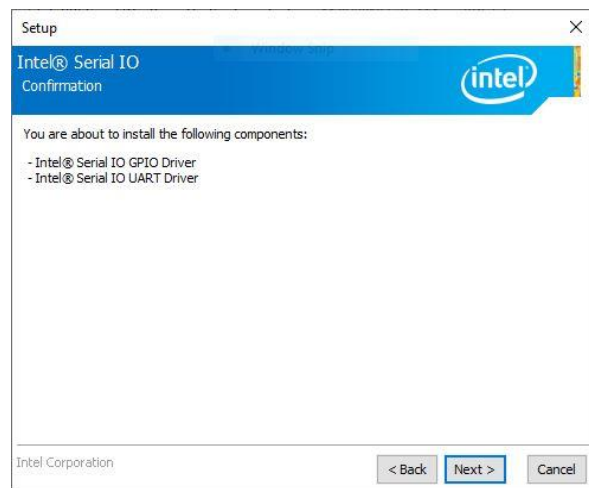

**Step 4. Click Next.**



**Step 2. Click Next.**



**Step 5. Click Finish** to complete setup.

## 4.7 Install IRST Driver



**Note:** The installation procedures and screen shots in this section are based on Windows 10 operation system.

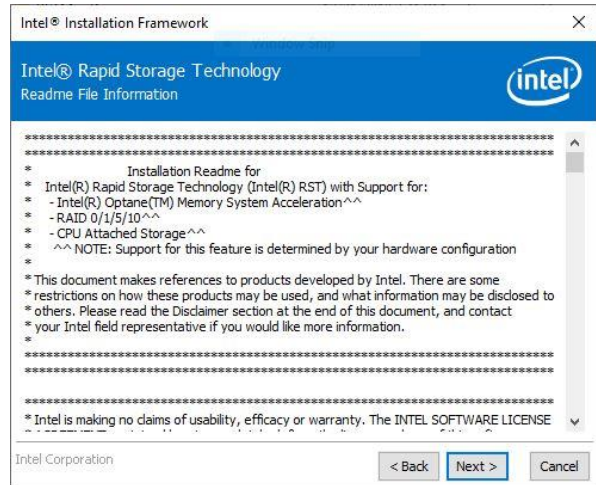

**Step 3. Click Next.**

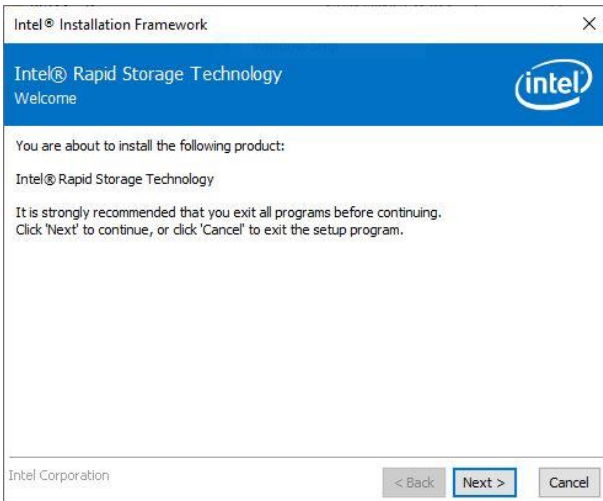

**Step 1. Click Next** to continue installation.

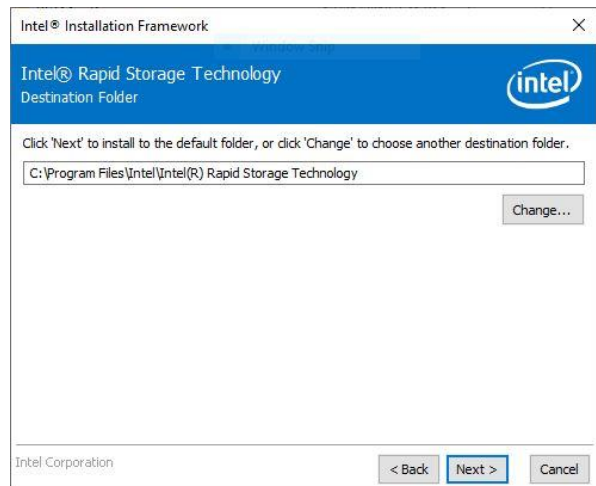

**Step 4. Click Next.**

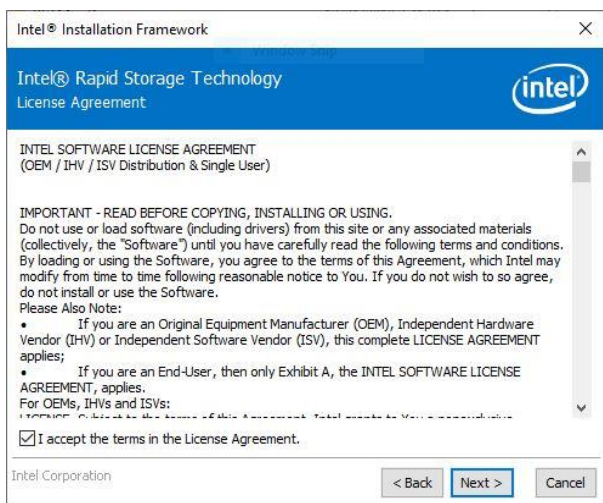

**Step 2. Click Next.**

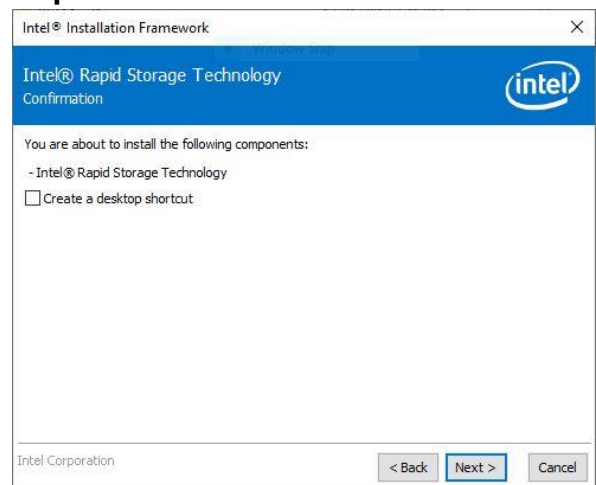

**Step 5. Click Next.**

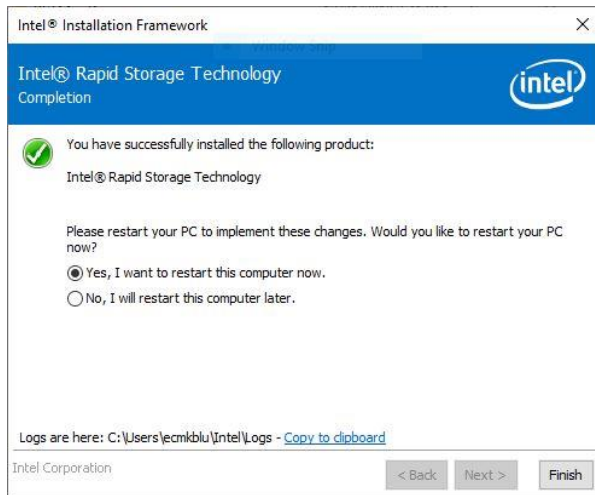

**Step 6.** Click **Finish** to complete setup.

# 5. Mechanical Drawing

---



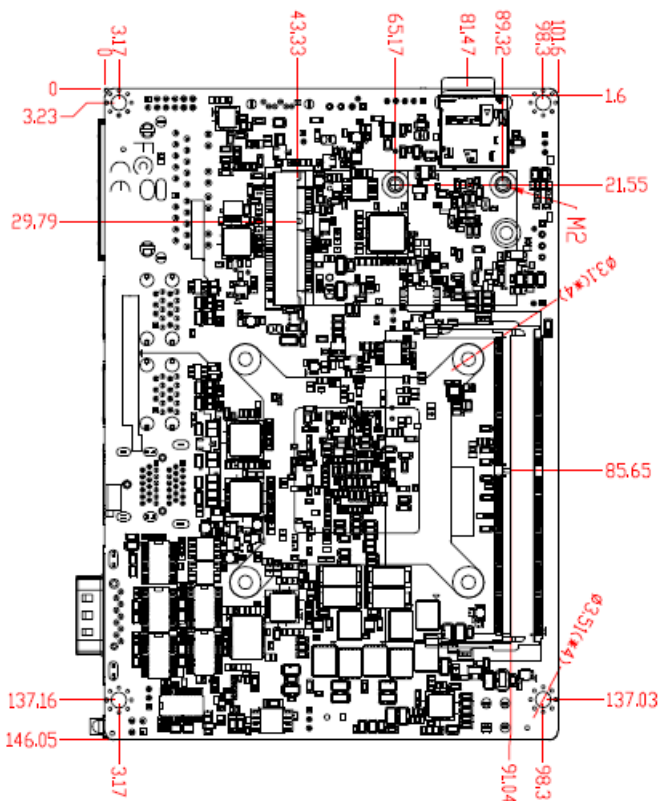
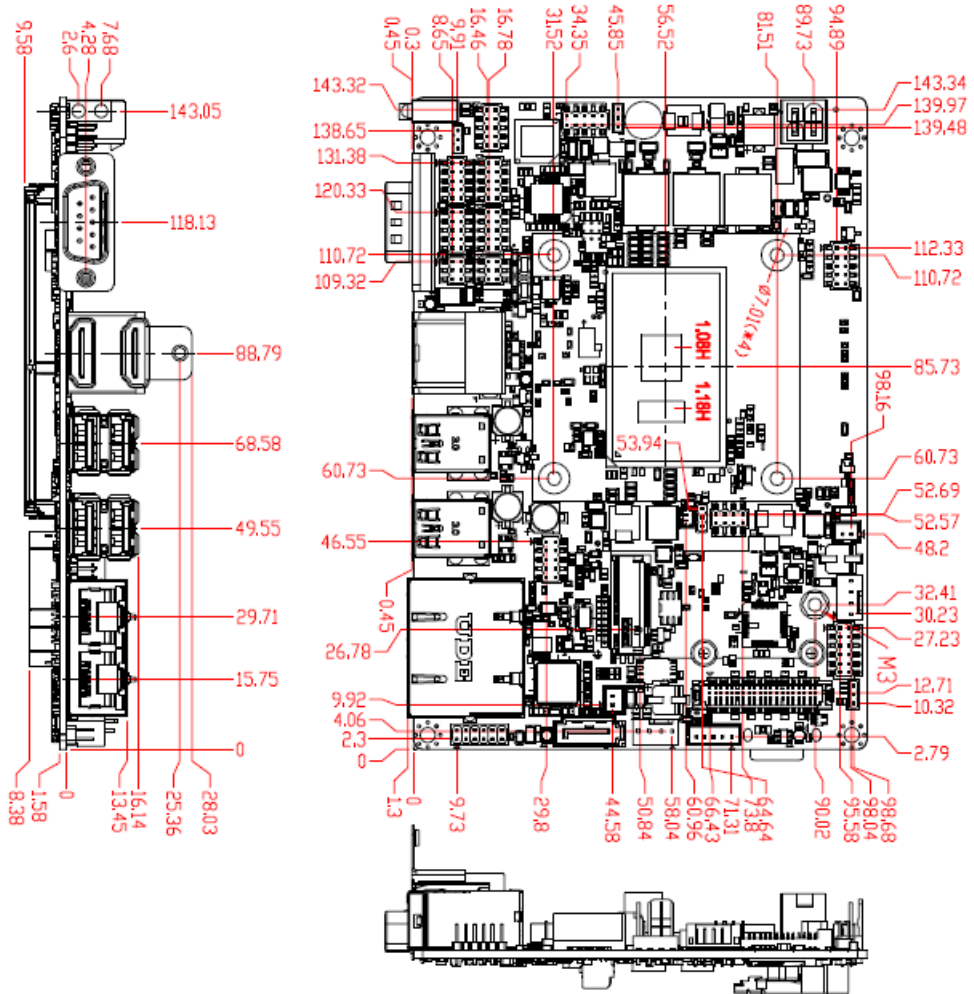

Unit: mm

